

Single-line automatic lubrication systems

Product catalogue 2023

INCL.
ADJUSTABLE
MODULAR GREASE
METERING
DEVICE
SL-32

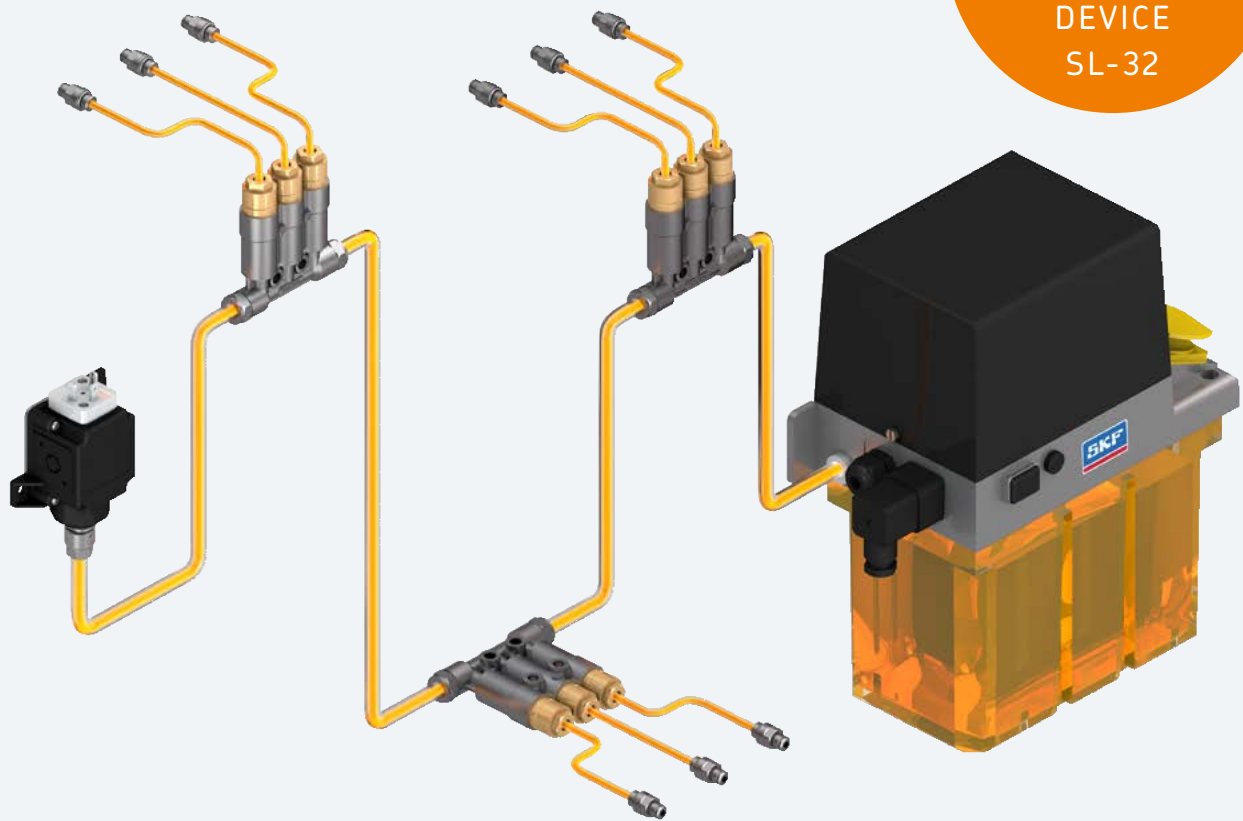

Electronic part library

CAD product data

Introduction

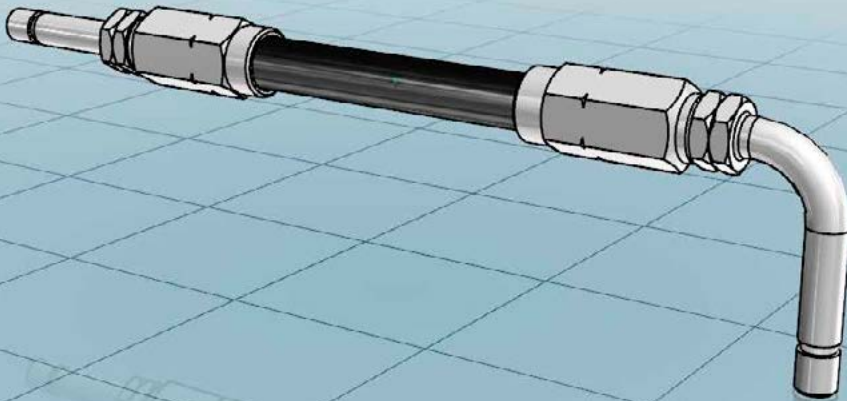

Find your parts online

3D CAD data, technical drawings and data sheets of SKF automatic lubrication system components are now available in native format in the online parts library. In addition to enjoying easy CAD downloads, you can configure more complex lubrication system products and integrate them into your design process – completely free of charge. Integrate CAD data seamlessly into your layout plans without any delay.



<https://skf-lubrication.partcommunity.com>

Introduction 2

Pumps and pump units for oil 13

Pumps and pump units for grease 45

Metering devices for oil 85

Metering devices for grease 123

Control units. 145

Pressure sensors 163

Flow monitors and sensors 181

Solenoid valves 185

Table of contents

| | | | |
|--|-----------|--|-----------|
| Electronic part library | 2 | MPB | 64 |
| Two leading brands | 6 | 84050, 85460 | 66 |
| Lubricants for lubrication systems | 7 | 282288 | 67 |
| System applications | 8 | P 603S | 68 |
| System description | 10 | Minilube | 70 |
| Overview of oil and fluid grease pumps and pump units | 13 | KFG | 72 |
| MCP | 14 | Multilube MLPV/MLPI | 74 |
| 1812 | 16 | P 653S | 76 |
| P-846-2 | 17 | E-PUMP | 78 |
| 501 (fixed metering quantity) | 18 | FK | 80 |
| 501 (adjustable metering quantity) | 20 | FlowMaster, electric | 82 |
| 283167 | 21 | Overview of oil and fluid grease metering devices | 85 |
| 82885, 83667 | 22 | 341 | 86 |
| P/PW/PF/PFW-289 | 23 | 340 | 88 |
| ACP | 24 | 361 | 90 |
| PPS30 | 26 | 310 | 92 |
| P-886 | 28 | 351 | 94 |
| 82676 | 29 | 350 | 96 |
| 82570 | 30 | 370 | 98 |
| 1826 | 31 | 391 | 100 |
| ECP | 32 | Manifold | 101 |
| P 653S (oil) | 34 | 390 | 102 |
| KFU | 36 | 321 G, T, W, G4, Module, G7 | 104 |
| MKU | 38 | AB | 106 |
| MKF | 40 | VN | 108 |
| MFE | 42 | OI-AL-SR | 110 |
| Overview of grease pumps and pump units | 45 | SL-42 | 112 |
| 83817 | 48 | SL-43 | 114 |
| 1810 | 49 | SL-41 | 116 |
| 40PGA | 50 | SL-44 | 118 |
| 82886, 83668 | 52 | OS-33, OS-4 | 120 |
| 82653/55, 83800/34 | 54 | | |
| 83167 | 55 | | |
| 83599 | 56 | | |
| HG 1000, HG 2000 | 57 | | |
| BPH | 58 | | |
| 84944, 84961 | 60 | | |
| 84960, 84962 | 61 | | |
| FlowMaster, hydraulic | 62 | | |

Table of contents

| | | | |
|--|------------|--|------------|
| Overview of grease metering devices | 123 | Overview of pressure sensors | 163 |
| SL-33 | 124 | DSA | 164 |
| B-doser | 126 | DSD | 166 |
| LG-doser | 128 | DSB | 168 |
| SL-32 | 130 | 69630 | 170 |
| SL-32HV | 132 | DSC1 | 171 |
| SL-1 | 133 | DSC2 | 172 |
| QSL | 134 | DSC3 | 173 |
| VR | 136 | 234-13161-9 | 174 |
| SLC | 138 | 2340-00000118 | 175 |
| SL-11 | 140 | 234-10330-4 | 176 |
| SL-V | 141 | 234-11272-4 | 177 |
| SL-V XL | 142 | 234-13161-5 | 178 |
| | | 2340-00000108 | 179 |
| Overview of control units | 145 | Overview of flow monitors and sensors | 181 |
| EXZT/IGZ | 146 | GS300 | 182 |
| ST-2240-LUB | 148 | HCC | 183 |
| ST-1240 | 150 | Overview of solenoid valves | 185 |
| ST-102 | 151 | 35024 | 186 |
| ST-102P | 152 | 350282, 350283 | 187 |
| 84501 | 153 | 253-14076-X | 188 |
| LMC 101 | 154 | E-VALV-S | 189 |
| EOT-1 / EOT-2 | 155 | E-VALV-L | 190 |
| 85307 | 156 | 525-320XX-1 | 191 |
| IG502-2-E | 157 | 161-110-031 | 192 |
| LMC 2 | 158 | 525-604XX-1 | 193 |
| LMC 301 | 160 | 161-140-050 | 194 |
| | | Index | 196 |

Two leading brands



One global leader

SKF and Lincoln have joined forces to provide you with the world's most complete portfolio of innovative lubrication solutions – from manual lubricators and tools, to the most advanced centralized and automatic lubrication systems available.

In addition to traditional lubrication products and systems, we offer customized solutions for many industries such as pulp and paper, steel, mining, agriculture, marine, rail, wind, construction, machine tool and automotive. SKF engineering and technical specialists partner with OEMs and end-users to develop system solutions based on customer requirements. We also offer a variety of control and monitoring equipment for ease of use and to help ensure proper lubrication.

Both SKF and Lincoln systems are available through our global network of lubrication experts, offering you world-class installation and ongoing support on a local level – today and into the future. With the power of this network, and more than 200 years of combined friction management experience, we can help you improve machine reliability, reduce maintenance, increase productivity, enhance safety and optimise manpower resources.

Lubricants for lubrication systems

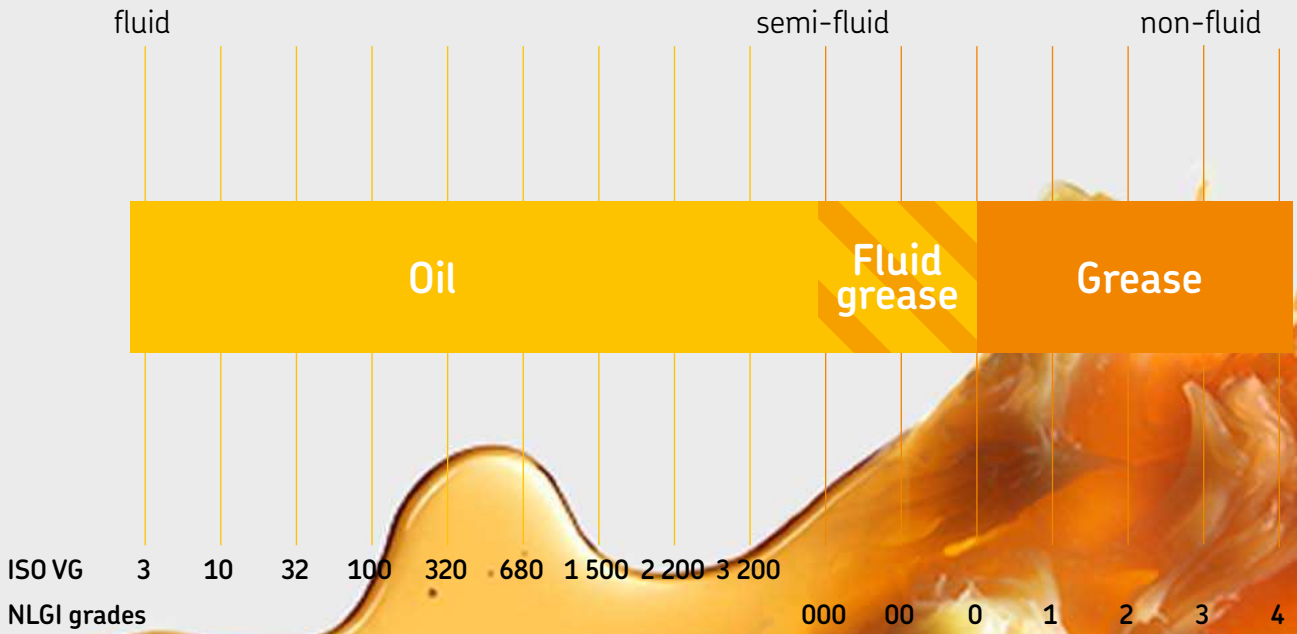

Oil and fluid grease

The viscosity is an expression of a fluid's internal friction. Oils are classified in ISO VG viscosity classes from 2 to 3 200. NLGI grade 000, 00 and 0 greases are called fluid greases. Different types of oils are available, including mineral oils, organic oils and synthetic oils. A compatibility check is recommended prior to using any oil with SKF lubrication systems.



Grease

Greases are consistent lubricants (NLGI grade 1–6). They are soft to hard, triple-component mixtures of a base oil as the lubricating fluid, a thickening agent and additives. In most instances, greases of NLGI grade 1 up to 3 are suitable for use in a lubrication system. A compatibility check should be made prior to using any grease with SKF lubrication systems.

System applications

Oil lubrication systems

In total loss lubrication systems, fresh lubricant is fed to friction points during a lubrication cycle. The lubrication cycle is set up so that friction points are supplied with enough lubricant to build up an adequate film of lubricant, reducing wear and tear on bearings and friction points. Monoflex and Centromatic systems are designed to allow for easy expansion and simple assembly.

- Small-to-medium line length
- Small-to-medium quantities of lubricant per lubrication point
- Ease of expansion
- Linear layout of lubrication points
- Flexibility of lubricant distribution
- Easy monitoring of lubrication distribution

Applications:

- Machine tools
- Mobile on-road (fleet vehicles, on-road transport)
- Assembly/automation
- Food packaging
- Part assembly lines
- Injection molding





Grease lubrication systems

Mining applications have been installed in the far north including the Oil Sands of Canada and Siberia and in the hot deserts of Africa and Australia. Major food, beverage, oil/gas, cement, steel, construction and rail customers also rely on SKF's single-line products. Single-line applications benefit from SKF's method of delivering precise amounts of lubricant at controlled intervals to the lubrication point.

- Mining
- On/Off-road
- Construction machinery
- Cement industry
- Food and beverage
- Machine tools
- Railroad
- Forestry
- Steel
- And more

System description

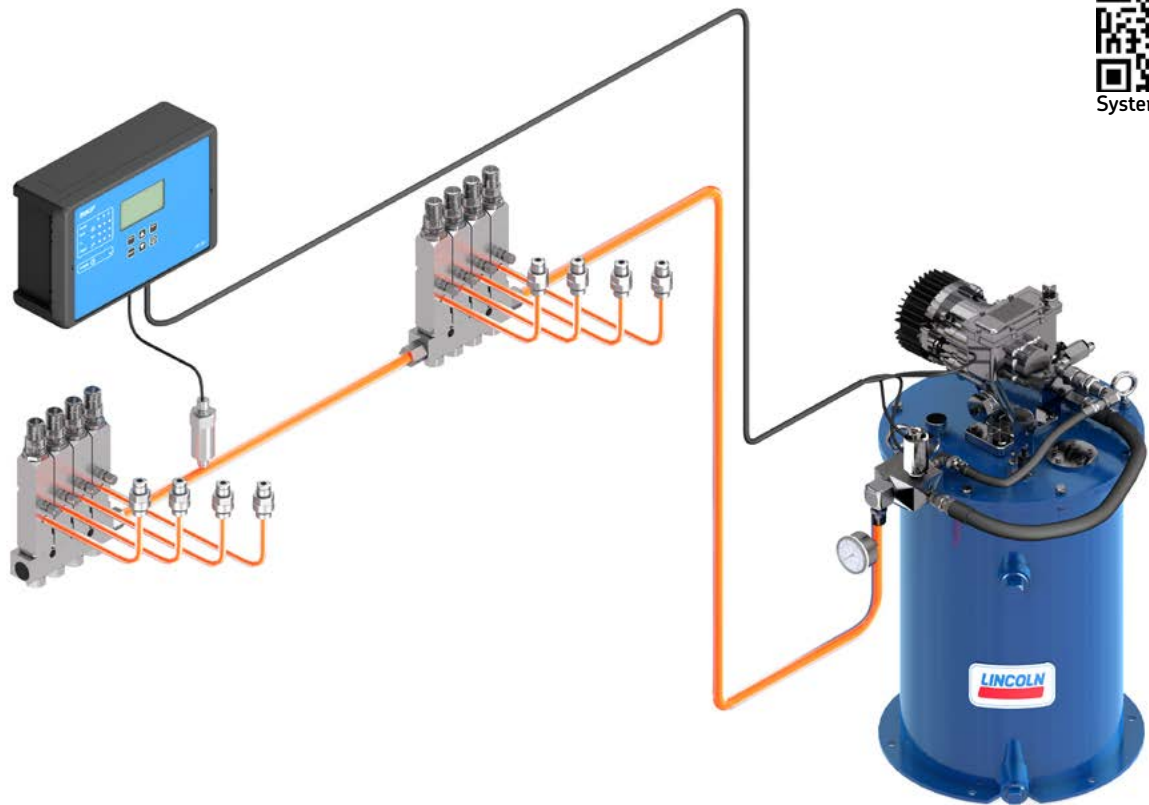

Single-line automatic lubrication systems

Single-line are total loss lubrication systems for oil, fluid grease and grease lubrication. They usually consist of lubricant reservoirs, pumps, single-line metering devices, control and monitoring devices, tubes or hoses, fittings and accessories. Regardless of the application, the principle of single-line lubrication remains the same: a central pump unit automatically delivers lubricant through a single supply line to the lubricant metering device(s). Each metering device outlet serves only one lubrication point and may be adjusted to deliver the precise amount of lubricant required.

Single-line systems become monitored and controlled by pressure switches and control units. These systems can serve one machine and segmented by way valves different zones on one machine or even several separate machines. Single-line lubrication systems (pumps) can be actuated mechanically, electrically or hydraulically.

Benefits

- Continuous automatic lubrication
- Easy to install, adjust, expand and maintain
- Available in both preset and adjustable models
- Integrated system control and monitoring
- Enables to pump lubricants over long distances
- Operate in wide temperature range
- Suitable for almost all lubricants
- Market proven solutions
- Globally available

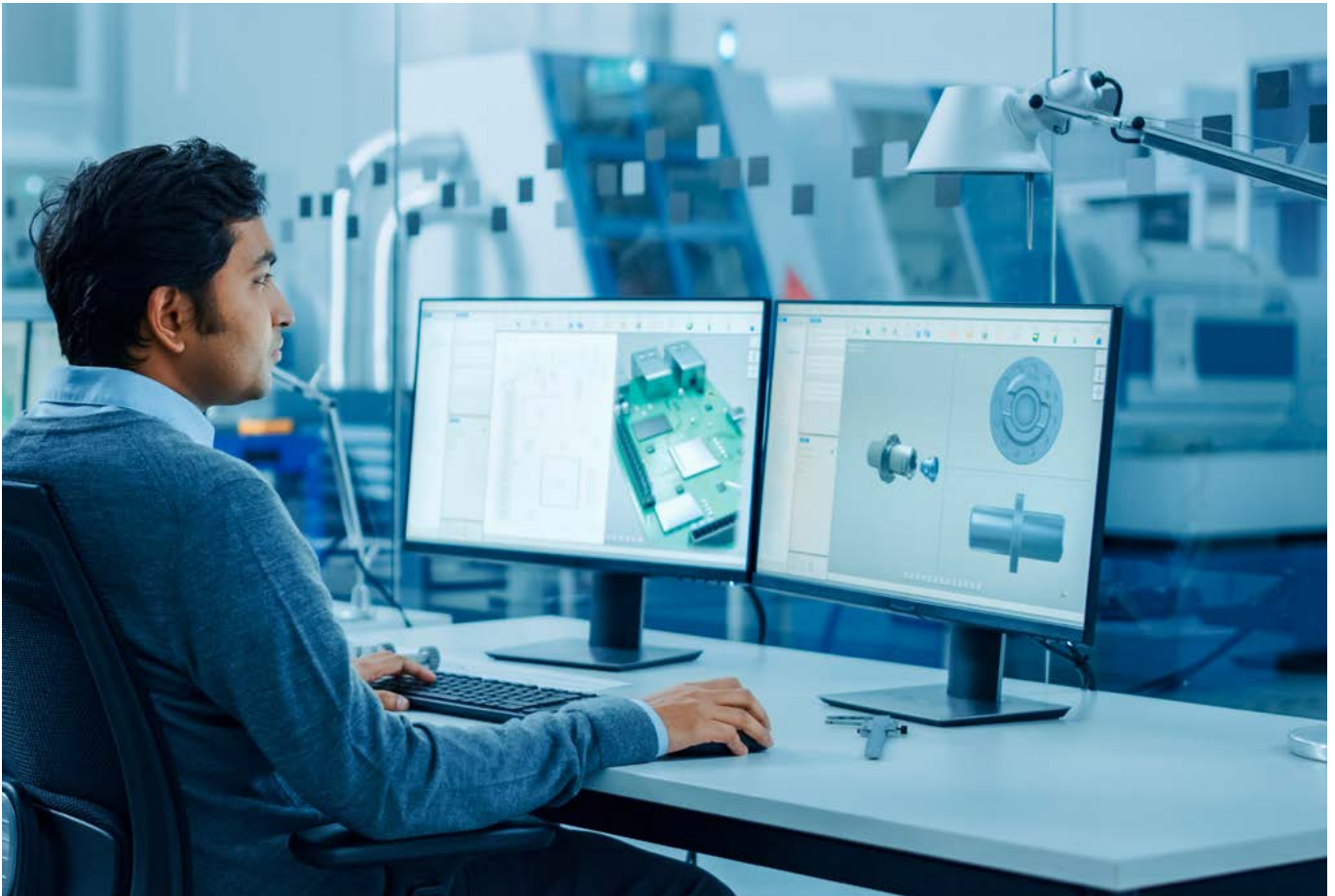

Step by step towards your tailor-made system

For planning a lubrication system, conditions the system will be used in need to be determined first. The number of lubrication points, back pressures at the lubrication points, operating temperature range, lubricant, the feed pump's drive energy, control and monitoring etc. need to be defined correctly. Attention to information on bearing or lubrication point information need to be paid too. The sum of all the quantities metered out by the system's metering devices needs to be completed by safety margin and expansion and compressibility loss.

SKF application engineers, as well as SKF sales partners and distributors, are experts in laying out lubrication systems according to all these specifications. A lubrication system laid out by SKF and partners ensures the supply of the correct amount of lubricant at the best time to lubricate. This reduces wear and avoids pollution caused by over-lubrication.

Product categories to support a quick system layout

SKF engineers have developed single-line metering device categories that allow an easy assignment of system key components as metering devices and pumps. At product selection phase it is now possible to choose a pump that matches with the correct category of lubricant metering devices given in product features list.

Single-line systems designed according this guiding categories result in proven pump and metering device combinations that allow to successfully go on with laying out reliable automated lubrication systems.

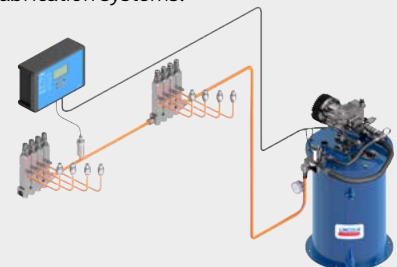



Overview of oil and fluid grease pumps and pump units

Manually operated pump units

| Product | Lubricant | | Metering quantity max. | | Operating pressure max. ¹⁾ | | Reservoir | | Metering device category ²⁾ | | | | Page |
|-------------|-----------|--------------|-------------------------|-------------------------|---------------------------------------|-------|-------------|------------------|--|---|---|---|------|
| | oil | fluid grease | cm ³ /stroke | in ³ /stroke | bar | psi | l | gal | 1 | 2 | 3 | 4 | |
| MCP | • | • | 15 | 0.91 | 38 | 551 | 0,5; 1; 1,7 | 0.13; 0.26; 0.45 | • | • | • | – | 14 |
| 1812 | • | – | 2,6 | 0.16 | 69 | 1 000 | 2,1 | 0.55 | – | • | • | • | 16 |

¹⁾ Select the correct fittings, adjust the operating pressure to fit the pressure range of the selected metering devices.

²⁾ Single-line metering devices are classified into categories according to their vent pressure in ascending order. Choosing the correct category guarantees the proper functioning of the lubrication system.

Air-operated pumps and pump units

| Product | Lubricant | | Metering quantity max. | | Operating pressure max. ¹⁾ | | Reservoir | | Metering device category ²⁾ | | | | Page |
|------------------------|-----------|--------------|-------------------------|-------------------------|---------------------------------------|-------|-------------|------------------|--|---|---|---|------|
| | oil | fluid grease | cm ³ /stroke | in ³ /stroke | bar | psi | l | gal | 1 | 2 | 3 | 4 | |
| 501 fixed | • | – | 0,003 | 0,00018 | 38 | 551 | 0,25 | 0,066 | – | – | – | – | 18 |
| 501 adjustable | • | – | 0,03 | 0,0018 | 38 | 551 | 0,20 | 0,052 | – | – | – | – | 20 |
| P-846-2 | • | – | 7 | 0.42 | 45 | 652 | – | – | • | • | • | – | 17 |
| 283167 | • | – | 1,97 | 0.12 | 69 | 1 000 | 7,1 | 1.88 | – | – | • | • | 21 |
| 82885, 83667 | • | – | 7,4 | 0.45 | 69 | 1 000 | 0,6; 2 | 0.16; 0.53 | – | • | • | • | 22 |
| P/PW/PF/PFW-289 | • | • | 10 | 0.61 | 40 | 580 | 1,5 | 0.39 | • | • | • | – | 23 |
| ACP | • | • | 15 | 0.91 | 38 | 551 | 0,5; 1; 1,7 | 0.13; 0.26; 0.45 | • | • | • | – | 24 |
| PP530 | • | • | 30 | 1.83 | 27 | 392 | 1,5 | 0.39 | • | • | – | – | 26 |
| P-886 | • | – | 30 | 1.83 | 35 | 508 | – | – | • | • | • | – | 28 |
| 82676 | • | – | 39,3 | 2.39 | 69 | 1 000 | – | – | – | – | – | • | 29 |
| 82570 | • | – | 39,3 | 2.39 | 69 | 1 000 | 2 | 0.53 | – | – | – | • | 30 |

Air-operated barrel pumps

| Product | Lubricant | | Metering quantity max. | | Operating pressure max. ¹⁾ | | Reservoir | | Metering device category ²⁾ | | | | Page |
|-------------|-----------------|--------------|------------------------|----------------------|---------------------------------------|-------|-----------|-------|--|---|---|---|------|
| | oil | fluid grease | cm ³ /min | in ³ /min | bar | psi | l | gal | 1 | 2 | 3 | 4 | |
| 1826 | ³⁾ • | – | 7 571 | 462 | 69 | 1 000 | 200 | 52.83 | – | • | • | • | 31 |

¹⁾ Select the correct fittings, adjust the operating pressure to fit the pressure range of the selected metering devices.

²⁾ Single-line metering devices are classified into categories according to their vent pressure in ascending order. Choosing the correct category guarantees the proper functioning of the lubrication system.

³⁾ Controller optionally

Electrically operated pumps and pump units

| Product | Lubricant | | Metering quantity max. | | Operating pressure max. ¹⁾ | | Reservoir | | Metering device category ²⁾ | | | | Page |
|--------------------|--------------------|--------------|------------------------|----------------------|---------------------------------------|------|-----------|------------------|--|---|---|---|------|
| | oil | fluid grease | cm ³ /min | in ³ /min | bar | psi | l | gal | 1 | 2 | 3 | 4 | |
| ECP | • | • | 12 | 0.73 | 38 | 550 | 0,38 | 0.086 | • | • | • | – | 32 |
| P653S (oil) | ^{3) 4)} • | – | 24,6 | 1.5 | 240 | 3500 | 4; 8 | 1.05; 2.11 | – | • | • | • | 34 |
| KFU | – | • | 140 | 8.5 | 38 | 550 | 2,7; 6 | 0.71; 1.56 | • | • | • | – | 36 |
| MKU | ³⁾ • | – | 100; 200; 500 | 6; 12; 31 | 30 | 435 | 2; 3; 6 | 0.53; 0.79; 1.56 | • | – | – | – | 38 |
| MKF | ³⁾ • | • | 100; 200; 500 | 6; 12; 31 | 30 | 435 | 2; 3; 6 | 0.53; 0.79; 1.56 | • | • | – | – | 40 |
| MFE | • | • | 250; 500 | 15; 31 | 28 | 405 | 3; 6; 15 | 0.79; 1.56; 3.96 | • | • | – | – | 42 |

¹⁾ Select the correct fittings, adjust the operating pressure to fit the pressure range of the selected metering devices.

²⁾ Single-line metering devices are classified into categories according to their vent pressure in ascending order. Choosing the correct category guarantees the proper functioning of the lubrication system.

³⁾ Controller optionally

⁴⁾ With pressure transducer

Pump unit

MCP

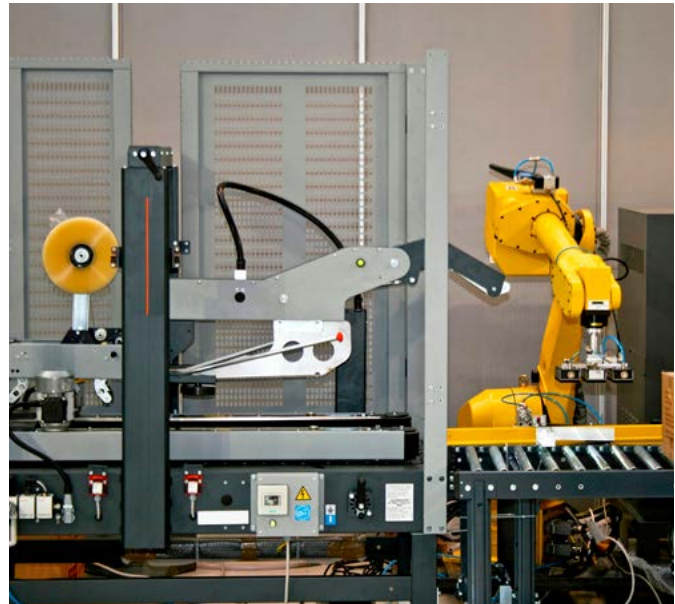

Description

The model MCP is a manual operated compact pump unit. Featuring a compact, lightweight design, that cost-effective pump is compatible with oil and fluid grease. Constructed of robust material, the pump is reliable in demanding applications. An optional fill-level monitor with prewarning functionality helps users to take early action.

Low operating pressures of up to 38 bar (551 psi) enable the use of SKF Quick Connector fittings and SKF single-line metering devices of category 1 without additional pressure regulation. The MCP pump replaces pump series POE/PFE.

Feature and benefits

- Simple to use, simple maintenance
- Easy system integration
- Reliable operation
- Lightweight and robust design, compact size
- Fill-level monitoring
- Suitable for use with oil and fluid grease metering devices of category 1, 2 and 3 (→ page 85)

Applications

- Simple machine tool and punching/laser machinery
- Process and packaging machinery
- Material handling devices
- Textile machinery
- Chain lubrication
- Cartesian robots
- Etc.

Technical data

| | |
|------------------------|--|
| Function principle | manually operated piston pump |
| Outlets | 2 |
| Metering quantity | up to 15 cm ³ /stroke up to 0.91 in ³ /stroke |
| Lubricant | mineral and synthetic oils with an operating viscosity of 20–1 500 mm ² /s fluid greases: NLGI 000, 00 |
| Operating temperature | 0 to +60 °C; 32 to 140 °F |
| Operating pressure | max. 38 bar, 551 psi |
| Reservoir | 0,5; 1,0; 1,7 l 0.13; 0.26; 0.45 gal |
| Protection class | IP 54 |
| Material (reservoir) | acrylic |
| Connection outlet | G ¹ / ₄ × 12 mm |
| Dimensions | |
| 0,5 l | 124 × 190 × 289 mm; 4.89 × 7.48 × 11.38 in |
| 1,0 l | 124 × 190 × 379 mm; 4.89 × 7.48 × 14.92 in |
| 1,7 l | 124 × 190 × 489 mm; 4.89 × 7.48 × 19.25 in |
| Mounting position | vertical |
| Weight (dep. on model) | 1,3–2,6 kg; 2.8–5.7 lb |

NOTE

Further technical information, technical drawings, accessories, spare parts or product function descriptions available on SKF.com/lubrication.

18962 EN, 951-170-237-EN



3D

skf-lubrication.partcommunity.com/3d-cad-models

Pump unit

MCP

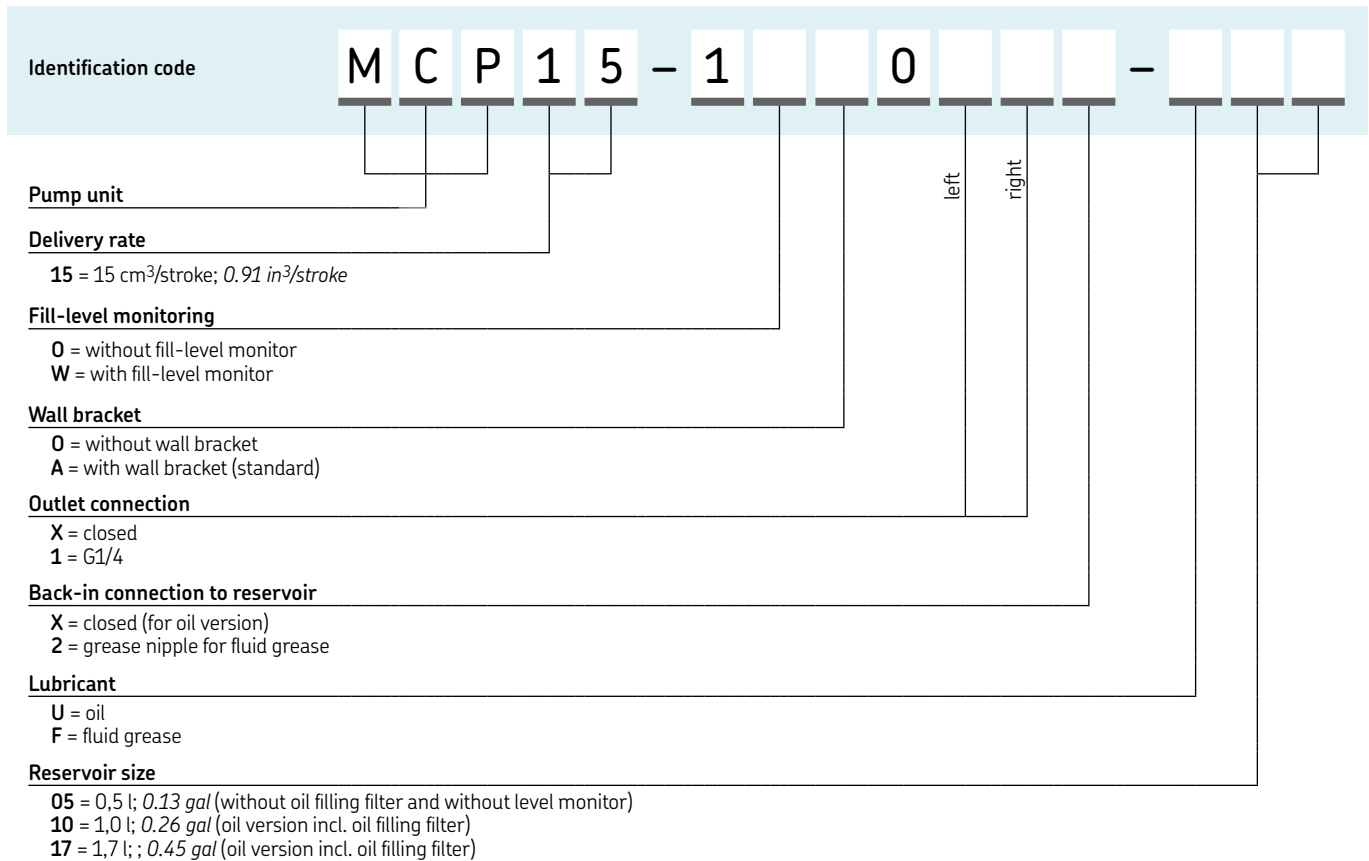

MCP standard product range

| Order number | Description |
|-------------------|---|
| MCP15-10A01X2-F05 | MCP for fluid grease with 0,5 l reservoir, without fill level monitor |
| MCP15-10A01X2-F10 | MCP for fluid grease with 1,0 l reservoir, without fill level monitor |
| MCP15-1WA01X2-F10 | MCP for fluid grease with 1,0 l reservoir, with fill level monitor |
| MCP15-10A01X2-F17 | MCP for fluid grease with 1,7 l reservoir, without fill level monitor |
| MCP15-1WA01X2-F17 | MCP for fluid grease with 1,7 l reservoir, with fill level monitor |
| MCP15-10A01XX-U05 | MCP for oil with 0,5 l reservoir, without fill level monitor |
| MCP15-10A01XX-U10 | MCP for oil with 1,0 l reservoir, without fill level monitor |
| MCP15-1WA01XX-U10 | MCP for oil with 1,0 l reservoir, with fill level monitor |
| MCP15-10A01XX-U17 | MCP for oil with 1,7 l reservoir, without fill level monitor |
| MCP15-1WA01XX-U17 | MCP for oil with 1,7 l reservoir, with fill level monitor |

Order example

MCP15-10A01XX-U17

- manual-operated compact pump
- delivery rate 15 cm³/stroke
- without fill-level monitoring
- with wall bracket
- without inlet connection
- G1/4 outlet connection left
- closed outlet connection right
- refill connection closed
- oil version
- reservoir 1,7 liter (with oil filling filter)

Pump unit

1812



Description

The 1812 pump features a translucent reservoir with filler cap and strainer. Its pump base has an integrated check/vent valve and an indicator pin to show when system pressure is achieved.

Feature and benefits

- Provides precise lubrication where air or electricity are not available
- Built-in vent valve activates when handle is pushed all the way up
- Pressure stem indicates 58 bar; 850 psi
- Suitable for use with oil metering devices of category 2, 3 and 4 (→ page 85)

Applications

- Textile
- Stationary
- Material handling including presses
- Agriculture and farming



Technical data

| | |
|-----------------------|---|
| Order number | 1812 |
| Function principle | manually operated piston pump |
| Outlets | 1 |
| Metering quantity | 2,6 cm ³ /stroke, 0.16 in ³ /stroke |
| Lubricant | oil, synthetic oil on request |
| Operating temperature | -23 to +65 °C -10 to +150 °F |
| Operating pressure | max. 70 bar, 1 000 psi |
| Reservoir | 2,13 l; 2 130 cm ³ 0.5 gal, 130 in ³ |
| Material (reservoir) | acrylic |
| Connection outlet | 1/4 NPTF (F) |
| Dimensions | 425 × 181 × 197 mm 16.75 × 7.125 × 7.75 in |
| Mounting position | vertical |



NOTE

Further technical information, technical drawings, accessories, spare parts or product function descriptions available on SKF.com/lubrication.

Pump unit

P-846-2



Description

Pump P-846-2 is an oil pump without reservoir made from metal, designed for remote or bulk-fill oil applications. It discharges lubricant on the air-powered forward stroke and releases pressure on the lubricant line through included check/relief valve through a M10x1 oil outlet.

Features and benefits

- Designed for remote or bulk-fill oil applications
- Remote system components available upon request
- Suitable for use with oil metering devices of category 1, 2 and 3 (→ page 85)

Applications

- Plastic processing
- Food and beverage
- Material handling
- Packaging



Technical data

| | |
|-----------------------|---|
| Order number | P-846-2 |
| Function principle | air operated piston pump |
| Outlets | 1 |
| Metering quantity | 7 cm ³ /stroke, 0.42 in ³ /stroke |
| Lubricant | mineral or synthetic oils, compliant with plastic, NBR-elastomers, cooper and copper alloys |
| Operating temperature | 10 to +60 °C 50 to +140 °F |
| Operating pressure | max. 45 bar, max. 652 psi |
| Actuation pressure | 2,5–8 bar, 36–116 psi |
| Reservoir | external |
| Connection outlet | M10x1 |
| Connection inlet | M14x1,5 |
| Air inlet connection | M10x1 |
| Protection class | IP 54 |
| Dimensions | 85 x 134 x 85 mm 3.34 x 5.27 x 3.34 in |
| Mounting position | any |



NOTE

Further technical information, technical drawings, accessories, spare parts or product function descriptions available on SKF.com/lubrication.

Pump unit

501 (fixed metering quantity)



Description

The SKF Lincoln injection oiler is designed to constantly lubricate with small volumes and very precise dosage. An improved piston design with a smaller diameter provide high accuracy and very small volumes. The constant oil flow with very small volumes allows to reduce maintenance times while keeping the machine working. In addition, the very small volumes also help to reduce the total oil consumption. The oil can be supplied from one central reservoir, a standalone reservoir, or by a central pressurized oil line. Metering elements can be actuated individually but also in groups.

Feature and benefits

- High accuracy
- Precise oil metering with very small, fixed metering volume
- Reduced total oil consumption
- Reduced maintenance time
- Improved process safety
- Combination to groups of maximum six oilers

Applications

- Material handling
- Presses and assembly lines
- Lubrication of pneumatic cylinders
- Machine tool spindles

Technical data

| | |
|-------------------------------|---|
| Function principle | air-operated high-precision piston pump, injection oiler |
| Outlets | 1-6 |
| Metering quantity ±20% | 2 mm ³ /stroke , 0.012 in ³ /stroke 3 mm ³ /stroke , 0.018 in ³ /stroke |
| Lubricant | mineral and synthetic oils compatible with NBR-elastomers, copper and copper alloys at an operating viscosity of 20-1100 mm ² /s |
| Operating temperature | -10 to +40 °C; 14 to 104 °F |
| Operating pressure | max. 38 bar, 551 psi |
| Reservoir | 0,25 l; 0.066 gal |
| Material | |
| Reservoir | PETP |
| Gaskets, seals | NBR, aluminum |
| Housing | aluminum anodized |
| Fittings | brass, steel zinc plated |
| Connection outlet | G1/4 |
| Inlet air connection | G1/8 |
| Inlet air pressure | 5-8 bar, 72-116 psi |
| Actuation frequency | min. 2 Hz |
| Protection class | IP 54 |
| Dimensions | |
| 1-port version w/o reservoir | 95 × 57 × 40 mm 3.74 × 2.23 × 1.57 in |
| 1-port version with reservoir | 117 × 73 × 128 mm 4.6 × 2.87 × 5.04 in |
| Mounting position | with reservoir upright without reservoir any |



NOTE

Further technical information, technical drawings, accessories, spare parts or product function descriptions available on SKF.com/lubrication.

19063EN, 501-301-310-S1

Pump unit

501 (fixed metering quantity)

Order information

| Order number | Number of outlets | Metering quantity per outlet | | Description | Weight | |
|--------------|-------------------|------------------------------|-------------------------|--|--------|------|
| | | mm ³ /stroke | in ³ /stroke | | kg | lbs |
| 501-301-302 | 1 | 2 | 0.012 | 1-port version w/o reservoir | 0,20 | 0.44 |
| 501-301-312 | 1 | 2 | 0.012 | 1-port with reservoir ¹⁾ | 0,48 | 1.06 |
| 501-302-302 | 2 | 2 | 0.012 | 2-port version w/o reservoir | 0,40 | 0.88 |
| 501-304-302 | 4 | 2 | 0.012 | 4-port version w/o reservoir | 0,80 | 1.76 |
| 501-306-302 | 6 | 2 | 0.012 | 6-port version w/o reservoir ²⁾ | 1,20 | 2.64 |
| 501-301-303 | 1 | 3 | 0.018 | 1-port version w/o reservoir | 0,20 | 0.44 |
| 501-301-313 | 1 | 3 | 0.018 | 1-port with reservoir ¹⁾ | 0,48 | 1.06 |
| 501-302-303 | 2 | 3 | 0.018 | 2-port version w/o reservoir | 0,40 | 0.88 |
| 501-304-303 | 4 | 3 | 0.018 | 4-port version w/o reservoir | 0,80 | 1.76 |
| 501-306-303 | 6 | 3 | 0.018 | 6-port version w/o reservoir ²⁾ | 1,20 | 2.64 |

¹⁾ The gravity reservoir is approved for use with the 1-port version only.

²⁾ More than six modules on request

501-304-302



501-306-302



Accessories

81-270-000



Order numbers for accessories

| Order number | Designation |
|-----------------|---------------------|
| 81-270-000 | Mounting bracket |
| 995-900-105+PL3 | Reservoir, complete |

Pump unit

501 (adjustable metering quantity)



Description

Metering pumps deliver lubricants in a measured amount. These piston pumps are for small delivery rates from 3 to 30 mm³. The lubricant's delivery rate is partially adjustable. All injection oilers are set for maximum delivery volume at the plant. The delivery rate can be reduced in increments by turning the setting sleeve counterclockwise. The oil can be supplied from one central reservoir, a standalone reservoir, or by a central pressurized oil line. Metering elements can be actuated individually or in groups.

Feature and benefits

- Optimal metering of every lubrication point regardless of line lengths and cross sections
- Metering elements can be actuated individually or in groups
- Splash lubrication through high oil acceleration
- Fast sequence of pulses: up to 120 pulses per minute
- Space saving design

Applications

- Material handling, presses and assembly lines
- Lubrication of pneumatic cylinders, machine tool spindles

Technical data

| | |
|------------------------------|--|
| Function principle | air-operated lubrication pump, injection oiler, micro pump |
| Outlets | 1 or 3 |
| Metering quantity | 3–30 mm ³ /stroke 0,00018– 0,0018 in ³ /stroke |
| Lubricant | mineral and synthetic oils compatible with NBR-elastomeres, copper and copper alloys at an operating viscosity of 10–1100 mm ² /s |
| Operating temperature | –10 to +80 °C 14 to 176 °F |
| Operating pressure | max. 38 bar, 551 psi |
| Reservoir | 0,20 l; 0.05 gal |
| Material | |
| Reservoir | PA6-3-T |
| Seals | NBR |
| Housing | zinc die-cast |
| Fittings | brass, steel zinc plated |
| Connection outlet | SKF Quick Connector for tube Ø4 mm (VS) or M6x0,75 for tube Ø2,5 mm |
| Inlet air connection | G1/8 |
| Inlet air pressure | 5–8 bar, 72–116 psi |
| Actuation frequency | max. 120 Hz |
| Protection class | IP 54 |
| Dimensions without reservoir | |
| 501-301-0... | 105 × 45 × 21 mm; 4.13 × 1.77 × 0.82 in |
| 501-303-0... | 105 × 72 × 21 mm; 4.13 × 2.83 × 0.82 in |
| Mounting position | oil duct vertical |

Order information

| Order number | Description | Outlet |
|----------------|---|---------|
| 501-301-024-VS | 1-port injection oiler without reservoir | VS * |
| 501-303-024-VS | 3-port injection oiler without reservoir | VS * |
| 501-301-011 | 1-port version with reservoir | M6x0,75 |
| 501-303-011 | 3-port version with reservoir | M6x0,75 |

* VS = SKF Quick Connector (for tube Ø4 mm)



NOTE

Further technical information, technical drawings, accessories, spare parts or product function descriptions available on SKF.com/lubrication.

1-5012-4-EN, 501-301-310-S1

Pump unit

283167



Description

Pump model 283167 includes air motor, vent valve, translucent reservoir with filler cap, strainer and 1 200 psi (82 bar) safety unloader. Pump is an oscillating positive displacement pump with pneumatic drive. The change-over valve of the pump drive controls reciprocating of the pump strokes (discharges oil to outlet on forward stroke and sucks oil on back stroke). The reciprocating pump operates under air pressure and as such discharges material until the required system oil pressure is built up. The shut off and monitoring of the pump must be initiated by a pressure switch, 3/2 way air valve, components to limit and adjust the air operating pressure. These parts are to be furnished on site of the user.

Features and benefits

- Reservoir with filler cap and internal strainer
- Vent valve assembly enclosed
- Remote system components available upon request
- Suitable for use with oil metering devices of category 3 and 4 (→ page 85)

Applications

- Steel mills
- Glass manufacturing plants
- Packaging
- Plastic processing
- Material handling
- Food and beverage
- Metal cutting, metal forming
- Systems with many lubrication points



Technical data

| | |
|-----------------------|---|
| Order number | 283167 |
| Function principle | air, reciprocating piston pump |
| Outlets | 1 |
| Metering quantity | 1,97 cm ³ /stroke, 0.12 in ³ /min |
| Working frequency | max. 100 cycles/min |
| Lubricant | oil, synthetic oils on request |
| Operating temperature | -23 to +65 °C -10 to +150 °F |
| Operating pressure | max. 70 bar, 1 000 psi |
| Reservoir | 7,1 l, 7 100 cm ³ , 1.8 gal, 433 in ³ |
| Material (reservoir) | acrylic |
| Air inlet connection | 1/8 NPTF (F) |
| Connection outlet | 3/4 NPTF (F) |
| Transmission ratio | 40:1 |
| Air valve | required, 3-way |
| Dimensions | 591 × 229 × 413 mm 23.25 × 9 × 16.25 in |
| Mounting position | vertical |

Note:
When operating the pump with air pressure > 1,7 bar a pressure switch for oil is required to limit the oil pressure (max. 68 bar) of the central lubrication system.



NOTE

Further technical information, technical drawings, accessories, spare parts or product function descriptions available on SKF.com/lubrication.

Pump unit

82885, 83667



Description

Model 82885, an air-operated, single-stroke oil pump, discharges lubricant on an air-powered forward stroke and releases pressure on the lubricant line on a spring-powered return stroke through an integrated check/relief valve (3 way). Its translucent reservoir is refilled through a filler cap with strainer. The pump unit is suitable for systems with a large number of lubrication points and clocked greasing strokes. Model 83667 offers the same features but includes a larger reservoir.

Feature and benefits

- Reliable operation
- Reservoir with filler cap and internal strainer
- Suitable for use with oil metering devices of category 2, 3 and 4 (→ page 85)

Applications

- Textiles and packaging
- Plastic processing
- Material handling
- Food and beverage
- Steel mills

Technical data

| | |
|-----------------------|---|
| Function principle | air operated piston pump |
| Outlets | 1 |
| Metering quantity | 7,4 cm ³ /stroke, 0.45 in ³ /stroke |
| Working frequency | |
| Lubricant | oil, synthetic oils on request |
| Operating temperature | -23 to +65 °C -10 to +150 °F |
| Operating pressure | max. 70 bar, 1 000 psi |
| Reservoir | 0,6 and 2,0 l; 0.16 and 0.5 gal |
| Material (reservoir) | acrylic |
| Connection outlet | 1/4 NPTF (F) |
| Air inlet connection | 1/4 NPTF (F) |
| Transmission ratio | 20:1 |
| Air valve | required, 3-way |
| Dimensions | min. 263 × 133 × 152 mm max. 470 × 140 × 152 mm min. 10.375 × 5.25 × 6 in max. 18.5 × 5.5 × 6 in |
| Mounting position | vertical |

Order information

| Order number | Reservoir | |
|--------------|-----------|------|
| | l | gal |
| 82885 | 0,6 | 0.16 |
| 83667 | 2,0 | 0.5 |



NOTE

Further technical information, technical drawings, accessories, spare parts or product function descriptions available on SKF.com/lubrication.

Pump unit

P/PW/PF/PFW-289



Description

These pneumatically actuated piston pumps were designed for intermittently operated, single-line centralized lubrication systems with metering devices. The valve set required for pressure relief and limitation is included.

Features and benefits

- Electrical monitoring via external controller or SPS
- Simple handling
- Optional low-level control for reservoir
- Suitable for use with oil and fluid grease metering devices of category 1, 2 and 3 (→ page 85)

Applications

- Machine tool
- Printing machines
- Industrial assembly and automation

Technical data

| | |
|--|---|
| Function principle | air operated piston pump (single stroke) |
| Outlets | 1 |
| Metering quantity | 10 cm ³ /stroke, 0.61 in ³ /stroke |
| Lubricant | mineral, synthetic, and environmentally friendly oils, operating viscosity 20 to 1 500 mm ² /s or fluid grease with NLGI 000, 00 |
| Operating temperature | +10 to +40 °C; +50 to +104 °F |
| Operating pressure | max. 40 bar, 580 psi |
| Reservoir | 1,5 l, 0.4 gal |
| Material (reservoir) | polycarbonate |
| Connection outlet | 6 mm, 0.24 in, OD tube |
| Dimensions | depending on model min. 170 × 248 × 128 mm max. 170 × 270 × 128 mm min. 6.7 × 9.8 × 5.04 in max. 6.7 × 10.6 × 5.04 in |
| Mounting position | vertical |
| Fill-level switch for monitoring the minimum fluid grease level | |
| Type of contact | 1 change-over |
| Switching voltage | 230 VAC; 230 VDC |
| Switching current | max. 230 VAC/DC: 1,0 A |
| Breaking capacity | max. 230 VAC: 60 VA; max. 230 VDC: 40 W |
| Type of enclosure | IP 65 |
| Cable gland | PG11 |

Order information

| Order number | Lubricant | | Fill-level switch |
|--------------|-----------|--------------|-------------------|
| | Oil | Fluid grease | |
| P-289 | • | – | – |
| PW-289 | • | – | • |
| PF-289 | – | • | – |
| PFW-289 | – | • | • |



NOTE

Further technical information, technical drawings, accessories, spare parts or product function descriptions available on SKF.com/lubrication:

1-1110-EN, 951-170-012



3D

skf-lubrication.partcommunity.com/3d-cad-models

Pump unit

ACP



Description

The model ACP is an air-operated compact pump unit. Featuring a compact, lightweight design, that cost-effective pump is compatible with oil and fluid grease. Constructed of robust material, the pump is reliable in demanding applications. An optional fill-level monitor with prewarning functionality helps users to take early action. Low operating pressures of up to 38 bar (551 psi) enable the use of SKF Quick Connector fittings and SKF single-line metering devices of category 1 without additional pressure regulation. The ACP pump replaces pump series POEP/PFEP.

Feature and benefits

- Simple to use
- Easy system integration
- Reliable operation, simple maintenance
- Lightweight and robust design, compact size
- Fill-level monitoring
- Suitable for use with oil and fluid grease metering devices of category 1, 2 and 3 (→ page 85)

Applications

- Simple machine tool and punching/laser machinery
- Process and packaging machinery
- Material handling devices
- Textile machinery
- Chain lubrication
- Cartesian robots
- Etc.

Technical data

| | |
|------------------------|--|
| Function principle | air operated piston pump |
| Outlets | 2 |
| Metering quantity | up to 15 cm ³ /stroke up to 0.91 in ³ /stroke |
| Lubricant | mineral and synthetic oils with an operating viscosity of 20–1 500 mm ² /s fluid greases: NLGI 000, 00 |
| Operating temperature | 0 to +60 °C; 32 to 140 °F |
| Operating pressure | max. 38 bar; 551 psi |
| Reservoir | 0,5; 1,0; 1,7 l 0.13; 0.26; 0.45 gal |
| Protection class | IP 54 |
| Material (reservoir) | acrylic |
| Connection outlet | G ¹ / ₄ × 12 mm |
| Air inlet connection | G ¹ / ₄ × 12 mm |
| Air actuation pressure | 3,5–10 bar; 50–145 psi |
| Dimensions | |
| 0,5 l | 124 × 108 × 251 mm; 4.89 × 4.25 × 9.88 in |
| 1,0 l | 124 × 108 × 341 mm; 4.89 × 4.25 × 13.42 in |
| 1,7 l | 124 × 108 × 451 mm; 4.89 × 4.25 × 17.75 in |
| Mounting position | vertical |
| Weight (dep. on model) | 1,3–2,6 kg; 2.8–5.7 lb |



NOTE

Further technical information, technical drawings, accessories, spare parts or product function descriptions available on SKF.com/lubrication.

18962 EN, 951-170-237-EN



3D

skf-lubrication.partcommunity.com/3d-cad-models

Pump unit

PPS30

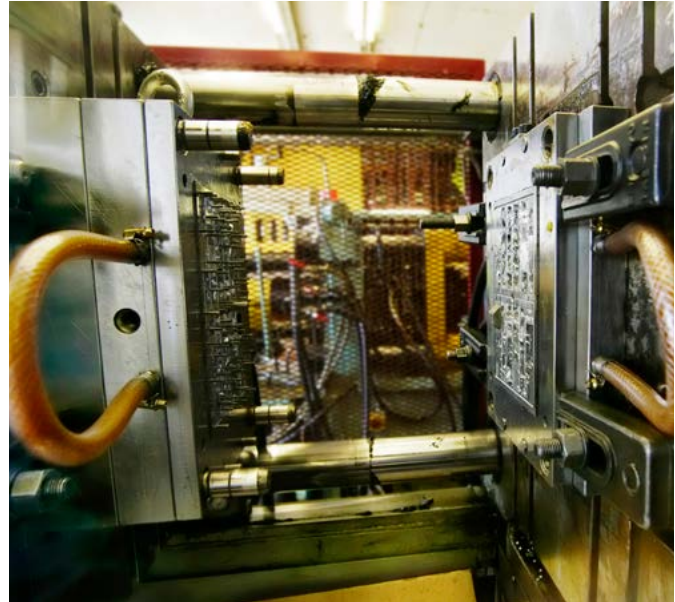

Description

Setting new standards in design, this compact unit combines proven lubrication technology with integrated functional elements. The easy-to-clean PPS30 features an integrated relief valve and electronic sensors, as well as a central opening for easy filling from all sides. In addition to low investment costs, it offers very low operating costs due to minimal compressed air consumption. The lightweight unit is made almost entirely of functional, high-performance plastics.

Features and benefits

- Compact, modern design with user friendly operation
- Quick and simple installation with flexible connection system
- Easy visual fill-level monitoring plus electric fill-level control
- Suitable for use with oil and fluid grease metering devices of category 1 and 2 (→ page 85)

Applications

- Machine tools
- Automation
- Packaging
- Woodworking
- Printing
- Textiles



NOTE

Further technical information, technical drawings, accessories, spare parts or product function descriptions available on SKF.com/lubrication:
1-0942-EN, 951-170-220 EN



3D

skf-lubrication.partcommunity.com/3d-cad-models

Technical data

| | |
|-------------------------|---|
| Function principle | air operated piston pump (single stroke) |
| Outlets | max. 3 |
| Metering quantity | 30 cm ³ /stroke, 1.83 in ³ /stroke |
| Working frequency | 6 strokes/h |
| Lubricant | mineral and synthetic oils, operating viscosity 20 to 1 500 mm ² /s or fluid grease NLGI 000, 00 |
| Operating temperature | +10 to +50 °C; +50 to +122 °F |
| Operating pressure | max. 27 bar, 392 psi |
| Actuation pressure | 4,5 to 6 bar; 65 to 87 psi |
| Reservoir | 1,5 l, 0.39 gal |
| Material (reservoir) | plastic (SAN) |
| Connection outlet | M10×1 thread or plug connector for pipes Ø6 and Ø8 mm or banjo fitting for pipe Ø6 mm |
| Air inlet | M10×1 thread or plug connector for pipes Ø6 and Ø8 mm or banjo fitting for pipe Ø6 mm |
| Transmission ratio | 4,5:1 |
| Air valve | required 3-way, see accessories |
| Pressure reducing valve | required, see accessories |
| Dimensions | 187 × 246 × 129 mm 7.3 × 9.6 × 5.1 in |
| Installation space | min. 230 × 300 × 250 mm min. 9 × 11.8 × 9.8 in |
| Mounting position | vertical |

Fill-level switch for monitoring the minimum lubricant level

| | |
|-------------------|------------------------|
| Function | capacitive, NC-contact |
| Switching voltage | 10 to 36 VDC |
| Power consumption | max. 150 mA |

Pressure switch for monitoring pressure build-up and function

| | |
|-----------------------|-----------------------------|
| Function | NO-contact |
| Rated pressure | 16 bar, 232 psi |
| Electrical connection | 4-pin M12 × 1 circular plug |

Pump unit

P-886

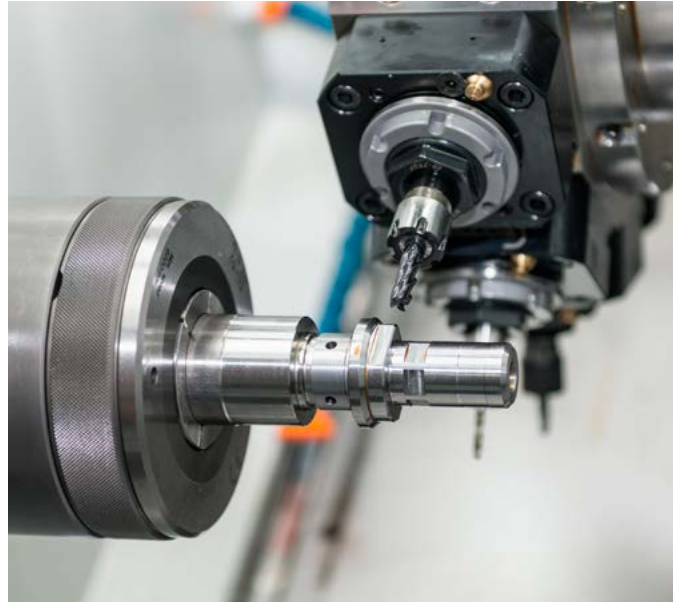

Description

Pump P-886 is a high-volume oil pump without reservoir made from metal designed for remote or bulk-fill oil applications. It discharges lubricant on the air-powered forward stroke and releases pressure on the lubricant line through included check/relief valve through a M10x1 oil outlet.

Features and benefits

- Designed for remote or bulk-fill oil applications
- Remote system components available upon request
- Suitable for use with oil metering devices of category 1, 2 and 3 (→ page 85)

Applications

- Plastic processing
- Food and beverage
- Material handling
- Packaging

Technical data

| | |
|--------------------------------|---|
| Order number | P-886 |
| Function principle | air or hydraulically operated piston pump |
| Outlets | 1 |
| Metering quantity | 30 cm ³ /stroke, 1.8 in ³ /stroke |
| Lubricant | mineral or synthetic oils, compliant with plastic, NBR-elastomers, cooper and copper alloys |
| Operating temperature | 10 to +40 °C 50 to +104 °F |
| Operating pressure | max. 35 bar, max. 508 psi |
| Actuation pressure | 4–10 bar, 58–145 psi |
| Reservoir | external |
| Connection outlet | M14×1,5 (for tube Ø8 mm) |
| Connection inlet | M16×1,5 (for tube Ø10 mm) |
| Air inlet connection | G1/4 (for tube Ø8 mm) |
| Return valve connection outlet | M10×1 (for tube Ø6 mm) |
| Protection class | IP 54 |
| Dimensions | 108 × 219 × 108 mm 4.25 × 8.62 × 4.25 in |
| Mounting position | any |

NOTE

Further technical information, technical drawings, accessories, spare parts or product function descriptions available on SKF.com/lubrication.

Pump unit

82676



Description

Pump model 82676 is a high-volume pump designed for remote or bulk-fill oil applications. It discharges lubricant on the air-powered forward stroke and releases pressure on the lubricant line through included check/relief valve through a 1/2 NPTF (F) oil outlet. (head pressure max. 5,5 bar; 80 psi)

Features and benefits

- Designed for remote or bulk-fill oil applications
- Remote system components available upon request
- Suitable for use with oil metering devices of category 4 (→ page 85)

Applications

- Steel mills
- Packaging
- Plastic processing
- Material handling
- Food and beverage



Technical data

| | |
|-----------------------|---|
| Order number | 82676 |
| Function principle | air operated piston pump (single stroke) |
| Outlets | 1 |
| Metering quantity | 39,3 cm ³ /stroke, 2.4 in ³ /stroke |
| Working frequency | |
| Lubricant | oil, synthetic oils on request |
| Operating temperature | -23 to +65 °C -10 to +150 °F |
| Operating pressure | max. 70 bar, 1 000 psi |
| Reservoir | external |
| Connection outlet | 1/4 NPTF (F) |
| Transmission ratio | 20:1 |
| Air valve | required, 4-way |
| Dimensions | 470 × 146 × 533 mm 18.5 × 5.75 × 21 in |
| Mounting position | vertical |



NOTE

Further technical information, technical drawings, accessories, spare parts or product function descriptions available on SKF.com/lubrication.

Pump unit

82570



Description

Pump model 82570 is a high-volume pump that discharges lubricant on the air-powered forward stroke and releases pressure on the lubricant line through included check/relief valve on the air-powered return stroke. Its acrylic reservoir is refilled through the filler cap with strainer.

Features and benefits

- Reservoir with filler cap and internal strainer
- Remote system components available upon request
- Suitable for use with oil metering devices of category 2, 3 and 4 (→ page 85)

Applications

- Textiles
- Steel mills
- Packaging
- Plastic processing
- Material handling
- Food and beverage

Technical data

| | |
|-----------------------|---|
| Order number | 82570 |
| Function principle | air operated piston pump (single stroke) |
| Outlets | 1 |
| Metering quantity | 39,3 cm ³ /stroke, 2.4 in ³ /stroke |
| Working frequency | |
| Lubricant | oil, synthetic oils on request |
| Operating temperature | -23 to +65 °C -10 to +150 °F |
| Operating pressure | max. 70 bar, 1 000 psi |
| Reservoir | 2,0 l, 0.5 gal |
| Reservoir material | acrylic |
| Connection outlet | 1/4 NPTF (F) |
| Transmission ratio | 20:1 |
| Air valve | required, 4-way |
| Dimensions | 451 × 146 × 464 mm 17.75 × 5.75 × 18.25 in |
| Mounting position | vertical |



NOTE

Further technical information, technical drawings, accessories, spare parts or product function descriptions available on SKF.com/lubrication.



Description

Pump model 1826 is modular assembled and consists of air motor, attached pump tube, vent valve assembly, drum cover, controller, lubricant connecting hoses and safety unloader. Modular structured air motor is fully pneumatically monitored. Supplied compressed air to air motor moves oscillating piston in cylinder up and down. Simultaneously outlet air pours out of opposite cylinder chamber via exhausting baffle. A signal valve operates as a sensor and forwards pneumatic signal pressure to a relay valve as soon as piston has reached its fully stroke in one direction. Relay valve now switches pneumatically movement of piston opposite. Oscillation operation is working. Pumps consist in two devices, air motor and pump tube with integrated shovel piston. Oscillation piston initiates shovel piston to pump operation by sucking and pumping function. Pumps are supplied in moduls must be furnished on side of user but can also supplied completely on request.

Features and benefits

- Midsize volume PowerMaster air motor
- Carbon steel pump tube with shovel-foot design, selected fit plunger and bushing
- Vent valve assembly and safety unloader included
- Drum cover for standard U.S. 55 gal. (200 l) drums (removable head)
- Simplified, modular design
- Wear-resistant and robust construction, reliable
- Suitable for use with oil metering devices of category 2, 3 and 4 (→ page 85)

Applications

- Steel mills, glass industry
- Plastic processing
- Food and beverage
- Material handling

Technical data

| | |
|----------------------------|--|
| Order number | 1826 |
| Function principle | air operated reciprocating piston pump |
| Outlets | 1 |
| Metering quantity | 7 571 cm ³ /min, 462 in ³ /min |
| Lubricant | oil |
| Pump tube 84991 | |
| Volume/cycle (up and down) | 100 cm ³ ; 6.10 in ³ |
| Max. pump cycles/minute | 70 permitted |
| Operating temperature | -34 to +93 °C -29 to +199 °F |
| Operating pressure | max. 70 bar; 1 000 psi |
| Air inlet | 3/8 NPTF (F) |
| Connection outlet | 3/4 NPTF (F) |
| Transmission ratio | 24:1 |
| Dimensions | |
| Total length | 1 464 mm; 57.64 in |
| Immersion length | 864 mm; 34.01 in |
| Mounting position | vertical |
| Controller | |
| Voltage | 110 VAC, 50 Hz; 120 VAC, 60 Hz |



NOTE

Further technical information, technical drawings, accessories, spare parts or product function descriptions available on SKF.com/lubrication.

Pump unit

ECP



Description

The Electric Cartridge Pump ECP was developed to lubricate bearings and linear guides in small machines. It includes an integrated pressure-relief. This electrically driven piston pump uses 24 VDC and is controlled by an external programmable logic controller (PLC) for convenience. In addition, the pump is capable of manually activating a lubrication cycle and can be used with an optional, integrated level switch to monitor the oil level of the cartridge. Utilizing easy-to-exchange cartridges, it is compatible with oil viscosities from 20 to 1 500 mm²/s and fluid grease grades of NLGI 00 and 000. Its 2 outlets can feed two lines simultaneously.

Features and benefits

- Cost effective solution
- Simple to operate
- Increases reliability
- Minimizes risk of using wrong or contaminated lubricant
- Reduces unplanned downtime
- Extends maintenance intervals
- Minimizes environmental impact via efficient use of lubricants
- Suitable for use with oil and fluid grease metering devices of category 1, 2 and 3 (→ page 85)

Applications

- Automation
- Machine tools
- Material handling
- Plastic processing
- Food and beverage



Technical data

| | |
|-----------------------|---|
| Function principle | electrically operated piston pump |
| Outlets | 2 |
| Metering quantity | fluid grease: 12 cm ³ /min; 0.73 in ³ /min oil: 0.012 l/min; 0.0027 gal/min |
| Lubricant | oil: 20 to 1 500 mm ² /s fluid grease: NLGI 00, 000 |
| Operating temperature | +10 to +50 °C; +50 to +122 °F |
| Operating pressure | max. 38 bar; 550 psi |
| Reservoir | prefilled cartridge with 120 ml; 4.06 oz. or 380 ml; 12.8 l. oz. or fixed reservoir 0,5; 1,0 or 1,7 l; 1,06; 2,1; 3,6 pt |
| Outlet connection | M10×1 thread or SKF Quick Connector 6–8 mm |
| Operating voltage | 24 VDC |
| Dimensions | without cartridge: 143×172×121 mm 5.63×6.77×4.76 in with cartridge: 307,5×172×121 mm 12.1×6.77×4.76 in with fixed reservoir: min. 240×239×210 mm min 9.45×9.40×8.27 in max. 240×439×210 mm min 9.45×17.28×8.27 in |
| Mounting position | upright |



NOTE

Further technical information, technical drawings, accessories, spare parts or product function descriptions available on SKF.com/lubrication:

16966 EN, 951-170-232



3D

skf-lubrication.partcommunity.com/3d-cad-models

Pump unit

ECP

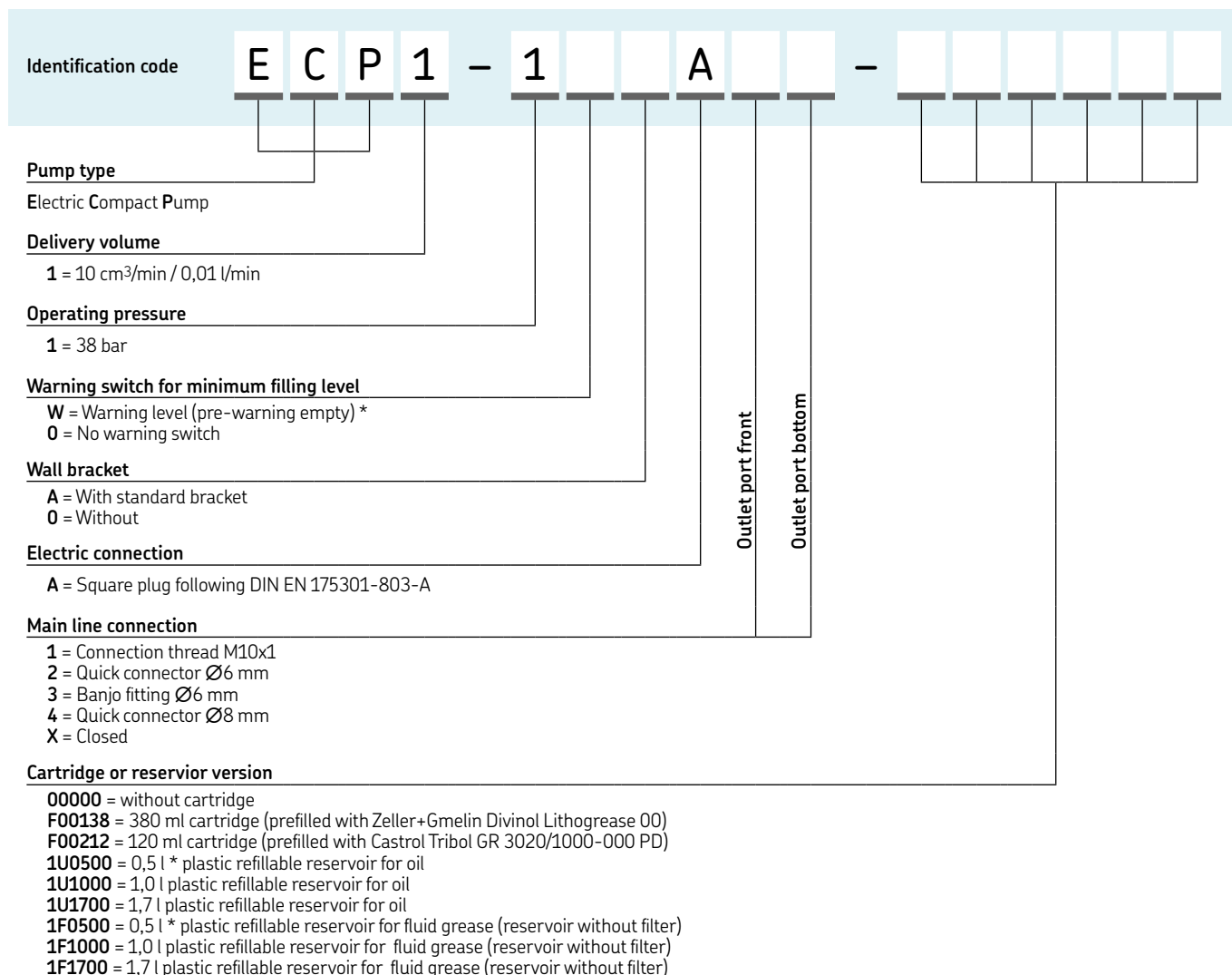

* NOTE: The 0,5 liter version can not be ordered with warning switch and/or oil filling filter.

Accessories

Pre-filled standard cartridges

| Lubricant ¹⁾ | Package | Order code |
|--|---------|--------------------|
| Castrol Tribol GR 3020/1000-000 PD ²⁾ | 10 pcs | LF002/MR120 |
| Castrol Tribol GR 3020/1000-000 PD ³⁾ | 10 pcs | LF002/MR380 |
| Zeller Gmelin Divinol Lithogrease 00 ³⁾ | 10 pcs | LF001/MR380 |

Main line connectors

| | |
|-------------------------|--------------------|
| Connection thread M10x1 | 898-110-120 |
| Quick connector Ø6 mm | 406-004-VS |
| Banjo fitting Ø6 mm | 506-140-VS |
| Quick connector Ø8 mm | 408-004-VS |
| Closing plug | 466-431-001 |

¹⁾ Further lubricants on request

²⁾ 120 ml

³⁾ 380 ml

Electrical connectors

| | |
|---|---------------------------|
| Rectangular connectors acc. to DIN EN175301-803-A | 179-990-033 / -147 |
| Circular plug M12x1, straight acc. to DIN EN61076-2-101 | 179-990-371 / -381 |
| Circular plug M12x1, angled acc. to DIN EN61076-2-101 | 179-990-372 / -382 |

Pressure-relief valves 60 bar for use in main line

| | |
|-----------------------------|--------------------|
| Pressure-relief valve Ø6 mm | 451-006-060 |
| Pressure-relief valve Ø8 mm | 451-008-060 |

Pump unit

P 653S (oil)

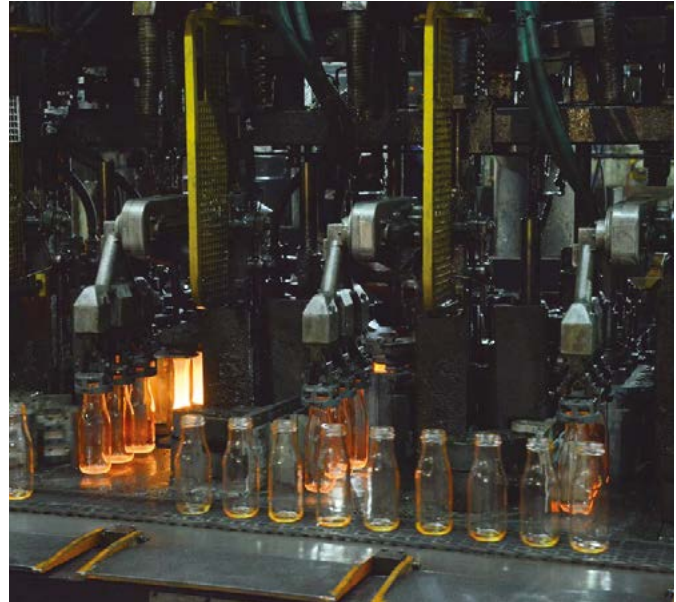

Description

Suitable for multiple applications, the Lincoln P 653S electrically driven oil pump simplifies the design of your lubrication system and delivers significant flexibility. A member of the Centro-Matic family, the pump comes complete with a reservoir, strainer, pressure transducer, vent valve and controller in one compact unit.

Features and benefits

- Integration of major system components reduces labor and overall costs
- Simplifies lubrication system design
- Reduces installation time via “plug-and-go” capability
- Minimizes lubricant consumption by running only when the machine is operating
- Suitable for use with oil metering devices of category 4 (→ page 85)

Applications

- Automation, machine tools
- Glass manufacturing plants
- Woodworking facilities
- Oil and Gas plants
- Steel plants

Technical data

| | |
|-----------------------|--|
| Function principle | electrically operated piston pump |
| Outlets | 1 |
| Metering quantity | 24,6 cm ³ /min, 1.5 in ³ /min |
| Lubricant | oil, minimum 40 mm ² /s (cST) |
| Operating temperature | 0 to +50 °C; +32 to +122 °F |
| Operating pressure | with pressure transducer: factory preset to 82 bar, 1 200 psi |
| Reservoir | 4, 8 and 16 l; 2 gal |
| Material (reservoir) | thermoplastic |
| Connection outlet | G 1/4 |
| Incoming voltage | 120/230 VAC ¹⁾ |
| Current | max. 1,7 A |
| Frequency | 47 to 63 Hz |
| Pause time | max. 59 h, 59 min min. 4 min |
| Pause time increments | 1 hr or 1 min |
| Pumping time | max. 12 min |
| Approvals | UL/CSA, CE |
| Dimensions | depending on model min. 240 × 467 × 235 mm max. 240 × 508 × 235 mm min. 9.5 × 18.4 × 9.25 in max. 9.5 × 20 × 9.25 in |
| Mounting position | upright |

¹⁾ 24 V DC version available on request.



NOTE

Further technical information, technical drawings, accessories, spare parts or product function descriptions available on SKF.com/lubrication:

16072 EN

Pump unit

P 653S (oil)

Order information

| Order number | Operating voltage | | Reservoir capacity | | Internal pressure transducer | Internal and end-of-line pressure switch | Internal and end-of-line pressure transducer | Lubricant pressure measured in |
|-------------------------------------|-------------------|--------------|--------------------|-----|------------------------------|--|--|--------------------------------|
| | 24 V DC | 120/230 V AC | l | gal | | | | |
| Display and pressure setting in psi | | | | | | | | |
| 80127 | – | • | 4 | 1 | • | – | – | psi |
| 80128 | – | • | 8 | 2 | • | – | – | psi |
| Display and pressure setting in bar | | | | | | | | |
| 645-41370-1 | • | – | 4 | 1 | • | – | – | bar |
| 645-41325-3 | • | – | 8 | 2 | • | – | – | bar |
| 6450-00000029 | • | – | 15 | 4 | • | – | – | bar |
| 645-41370-2 | – | • | 4 | 1 | • | – | – | bar |
| 645-41370-3 | – | • | 4 | 1 | • | – | – | bar |

Pump unit

KFU



Description

The gear pump continuously supplies lubricant to relubrication metering devices via the main line network when the pump is in operation. When the metering chambers of the metering devices are full, excess lubricant flows back into the reservoir via the safety valve. At the end of the pump running time, the pressure relief valve opens so that pressure in the main line drops to a residual pressure of 0.2 to 1.0 bar (2.9 to 14.5 psi), allowing the spring-loaded pistons of the metering devices to deliver lubricant from the metering chambers to the lubrication points.

Features and benefits

- Includes gear pump with relief valve, safety valve, DC motor, transparent lubricant reservoir, filler socket and angle bracket
- Hood protects DC motor and filler socket from contaminants
- Minimizes wear and tear
- Reduces downtime
- Lowers maintenance costs via automatic lubrication
- Suitable for use with fluid grease metering devices of category 1, 2 and 3 (→ page 85)

Applications

- Agriculture
- Construction machinery
- Trucks, trailers and buses

Technical data

| | |
|-----------------------|--|
| Function principle | electrically operated gear pump |
| Outlets | 1 |
| Metering quantity 1) | 140 cm ³ /min, 8.5 in ³ /min |
| Lubricant | fluid grease, NLGI 000, 00 |
| Operating temperature | -25 to +75 °C; -13 to +167 °F |
| Operating pressure | max. 38 bar, 550 psi |
| Reservoir | 2,7 or 6 l; 0.7 or 1.6 gal |
| Material | steel, plastic sealings: FKM, NBR reservoir: translucent plastic |
| Main connection | Mainly plastic tubing Ø 10 x 1.5 but also steel tubing Ø 10 x 0.7 |
| Secondary connection | hose SLH10-... Mainly plastic tubing Ø 4 x 0.85; in case of large movement between lubrication point and chassis: hose 734 ... |
| Operating voltage | 12 or 24 VDC |
| Protection class | IP 59k |
| Dimensions | min. 268 x 154 x 325 mm max. 343 x 184 x 364 mm min. 10.5 x 6 x 12.7 in max. 13.5 x 7.2 x 14.3 in |
| Mounting position | vertical |

1) At back pressure 38 bar (550 psi) and temperature +25 °C (+77 °F)

NOTE

Further technical information, technical drawings, accessories, spare parts or product function descriptions available on SKF.com/lubrication:
1-9420-EN, 951-170-006_EN



3D
skf-lubrication.partcommunity.com/3d-cad-models

Pump unit

KFU

Order information

| Order number | Reservoir | | Operating voltage | |
|----------------------------------|-----------|------|-------------------|-----|
| | l | gal | VDC | Amp |
| KFU2-40+912 | 2,7 | 0.71 | 12 | 7.5 |
| KFU2-40+924 | 2,7 | 0.71 | 24 | 7.5 |
| KFU6-20+912 ¹⁾ | 6 | 1.6 | 12 | 7.5 |
| KFU6-20+924 ¹⁾ | 6 | 1.6 | 24 | 7.5 |
| KFUS2-64+924 | 2,7 | 0.71 | 24 | 8 |

¹⁾ This unit should only be used for systems with a minimum lubricant consumption of 6 l (1.6 gal) per year.

Pump unit

MKU



Description

MKU gear pump units are used in single-line oil lubrication systems and include a pre-installed pressure-regulating valve and pressure-relief valve. These units can be supplied with an optional pressure gauge for visual monitoring of pressure changes in the main line. Electrical pressure monitoring is performed by an integrated pressure switch, and fill-level monitoring also is possible. The pump units are controlled externally via the machine control system or an integrated control unit. Also, MKU units can be supplied with a push-button to activate interim lubrication at any time. Main functions are integrated into the lid, and a plastic cap protects the electrical components from contaminants such as dirt and dust.

Features and benefits

- Integrated pressure limitation and pressure relief valve
- Optional: electrical pressure switch, pressure gauge, float switch
- External control via SPS or by means of internal control unit possible
- All important functions integrated into the lid
- Modular construction
- Suitable for use with oil metering devices of category 1 (→ page 85)

Applications

- Material handling
- Automotive
- Machine tool
- Printing and finishing
- Industrial assembly and automation
- Textiles

Technical data

| | |
|--------------------------------|--|
| Function principle | electrically operated gear pump |
| Metering quantity | 100; 200; 500 cm ³ /min 6; 12; 31 in ³ /min |
| Lubricant | mineral oil or synthetic oil, 20 to 1 500 mm ² /s |
| Operating temperature | +10 to +40 °C +50 to +104 °F |
| Operating pressure | max. 30 bar, 435 psi |
| Reservoir | 2,0; 3,0 and 6,0 l 0,5, 0,8 and 1,6 gal |
| Material (reservoir) | plastic, metal |
| Connection outlet | G 1/4 |
| Operating voltage | 24 VDC; 115 VAC; 230 VAC |
| Protection class | IP 54 |
| Dimensions: pump unit with | |
| 2 l; 0,5 gal plastic reservoir | 204 × 130 × 298 mm 8 × 5,2 × 11,7 in |
| 3 l; 0,8 gal plastic reservoir | 286 × 132 × 298 mm 11,3 × 5,2 × 11,7 in |
| 3 l; 0,8 gal metal reservoir | 286 × 132 × 313 mm 11,3 × 5,2 × 12,3 in |
| 6 l; 1,5 gal plastic reservoir | 290 × 178 × 334 mm 11,4 × 7 × 13,2 in |
| Mounting position | vertical |



NOTE

Further technical information, technical drawings, accessories, spare parts or product function descriptions available on SKF.com/lubrication:
1-1203-EN, 951-170-005 EN



3D

skf-lubrication.partcommunity.com/3d-cad-models

Pump unit

MKU

Identification code **M K U - 1** **0 0 0 +**

Product series MKx

Lubricant
U = Oil

Delivery rate

| | | | | |
|---------------|---|---|---|---|
| 1 = 0.1 l/min | • | • | • | - |
| 2 = 0.2 l/min | - | • | • | • |
| 5 = 0.5 l/min | - | • | • | • |

Lubricant reservoir, control

| | | | | |
|---|--------------|--------------|------------|--------------|
| Lubricant reservoir | 1 | 2 | 3 | 4 |
| | 2 l, plastic | 3 l, plastic | 3 l, metal | 6 l, plastic |
| Control | | | | |
| A = No control, with terminal strip | • | • | • | • |
| B = No control, with terminal strip and push button | • | • | • | • |
| C = IG38-30-1 ¹⁾ | - | • | • | • |
| D = IZ38-30-1 ¹⁾ | - | • | • | • |
| E = IGZ36-20-S6-1 ¹⁾²⁾ | - | • | • | • |

Monitoring

| | | | | | | |
|--|----------|----------|----------|----------|----------|----------|
| | X | A | B | C | D | E |
| Fill-level switch | | | | | | |
| Without fill-level switch | • | • | - | - | - | - |
| NC contact (detection of wire breakage) | - | - | • | • | - | - |
| NO contact (no detection of wire breakage) | - | - | - | - | • | • |
| Pressure switch 20 bar | | | | | | |
| Without pressure switch | • | - | • | - | • | - |
| NO contact | - | • | - | • | - | • |

Code number for delivery rate

Selected code number for lubricant reservoir

Selected code letter for control

Selected code letter for monitoring

Selected code number for pressure gauge

Selected code number for electrical connection

Voltage key

| | | | |
|-------------------|----------------|------------------|----------------|
| | Voltage | Frequency | Control |
| 924 ³⁾ | 24 V DC | - | A, B, E |
| 428 | 230 V AC | 50/60 Hz | A, B, C, D, E |
| 429 | 115 V AC | | |

³⁾ Only possible with delivery rates 0.1 and 0.2 l/min

Electrical connection

| | | | | | | |
|---|----------|----------|------------|----------|----------|----------|
| Control | A | B | A,B | C | D | E |
| Monitoring | X | A | B | C | D | E |
| Electrical connection | | | | | | |
| 0 = 2 cable fittings | - | • | • | • | • | - |
| 1 = 1 cable fitting; 1 rectangular connector | - | • | • | • | • | • |
| 2 = 1 circular connector M12x1; 1 rectangular connector ⁴⁾ | - | • | • | • | • | - |
| 3 = 1 sealing plug; 1 cable fitting | • | - | - | - | - | - |
| 4 = 1 sealing plug; 1 rectangular connector | • | - | - | - | - | - |

⁴⁾ Only for design without control.

Pressure gauge

0 = without pressure gauge
1 = with pressure gauge

Order example

MKU1-11AC10000+924

- Gear pump unit for oil
- Delivery rate 0.1 l/min
- 1st generation
- 2 l plastic reservoir
- No control, with terminal strip
- NC fill-level switch,
- NO pressure switch
- With pressure gauge
- 2 cable fittings
- Voltage 24 VDC

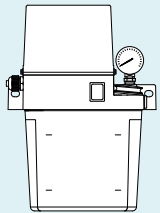

Pump unit

MKF



Description

MKF gear pump units are used in single-line systems to supply fluid greases NLGI 000 and 00 and include a pressure-regulating valve and pressure-relief valve. Electrical pressure monitoring is performed by an integrated pressure switch, and fill-level monitoring also is possible. These units are controlled externally via the machine control system or an integrated control unit. Also, MKF units can be supplied with a pushbutton to activate interim lubrication at any time. Main functions are integrated into the lid, and a plastic cap protects the electrical components from contaminants such as dirt and dust.

Features and benefits

- Integrated pressure-limitation and pressure-relief valve
- Optional: electrical pressure switch, pressure gauge, float switch
- External control via SPS or by means of internal control unit possible
- All important functions integrated into the lid
- Modular construction
- Suitable for use with fluid grease metering devices of category 1 and 2 (→ page 85)

Applications

- Material handling
- Automotives
- Machine tool
- Printing and finishing
- Industrial assembly and automation
- Textiles

Technical data

| | |
|--------------------------------|---|
| Function principle | electrically operated gear pump |
| Metering quantity | 100; 200; 500 cm ³ /min 6; 12; 31 in ³ /min |
| Lubricant | fluid grease NLGI 000 or 00, compatible with plastics, NBR elastomers, copper and copper alloys |
| Operating temperature | +10 to +40 °C; +50 to +104 °F |
| Operating pressure | max. 30 bar, 435 psi |
| Reservoir | 2,0; 3,0 and 6,0 l, 0,5, 0,8 and 1,6 gal |
| Material (reservoir) | plastic, metal |
| Connection outlet | G1/4 |
| Operating voltage | 24 VDC; 115 VAC; 230 VAC |
| Protection class | IP 54 |
| Dimensions: | |
| pump unit with | |
| 2 l; 0,5 gal plastic reservoir | 204 × 130 × 298 mm 8 × 5,2 × 11,7 in |
| 3 l; 0,8 gal plastic reservoir | 286 × 132 × 298 mm 11,3 × 5,2 × 11,7 in |
| 3 l; 0,8 gal metal reservoir | 286 × 132 × 313 mm 11,3 × 5,2 × 12,3 in |
| 6 l; 1,5 gal plastic reservoir | 290 × 178 × 334 mm 11,4 × 7 × 13,2 in |
| Mounting position | vertical |



NOTE

Further technical information, technical drawings, accessories, spare parts or product function descriptions available on SKF.com/lubrication:

1-1203-EN, 951-170-005 EN



3D

skf-lubrication.partcommunity.com/3d-cad-models

Pump unit

MFE



Description

The gear pump units comprising the MFE series are designed to supply lubricant used in intermittently operated, single-line centralized lubrication systems. The basic setup includes a gear pump unit with motor, a 3- or 6 l lubricant reservoir in metal or plastic, or a 15 l metal reservoir and float switch to monitor the minimum permissible level of lubricant. In addition to the basic models, units can be outfitted with add-ons.

Features and benefits

- Integrated float switch for fill-level monitoring
- Integrated pressure-relief valve and pressure-regulating valve
- Motors available for various voltage ranges and approvals
- Special designs offered for a wide range of applications
- Suitable for intermittent operation
- For remote installation out of reservoir or for built-in reservoir
- Reliable and versatile
- Suitable for use with oil and fluid grease metering devices of category 1 and 2 (→ page 85)

Applications

- Automotive manufacturing
- Metal, including presses
- Machine tools
- Printing and finishing
- Industrial assembly and automation



Technical data

| | |
|--------------------------------|---|
| Function principle | electrically operated gear pump |
| Outlets | 1 |
| Metering quantity | 250 to 500 cm ³ /min, 15 to 31 in ³ /min |
| Lubricant | oil 5 to 2 000 mm ² /s and fluid grease NLGI 00, 000 |
| Operating temperature | -10 to +60 °C; +14 to +140 °F |
| Back pressure | max. 17.5; 28 bar max. 255, 405 psi |
| Reservoir | 3; 6; 15 l, 0.8, 1.6, 4 gal |
| Material (reservoir) | plastic, metal |
| Connection outlet | M14×1.5 |
| Operating voltage | 230/400 V AC |
| Protection class | IP 54 |
| Dimensions: | |
| 3 l; 0.8 gal plastic reservoir | 303 × 130 × 245 mm; 11.9 × 5.1 × 9.6 in |
| 3 l; 0.8 gal metal reservoir | 332 × 178 × 312 mm; 13 × 7 × 12.3 in |
| 6 l; 1.5 gal plastic reservoir | 319 × 128 × 265 mm; 12.6 × 5 × 10.4 in |
| 6 l; 1.5 gal metal reservoir | 370 × 167 × 330 mm; 14.6 × 6.6 × 12.9 in |
| 15 l; 4 gal metal reservoir | 453 × 200 × 436 mm; 17.8 × 7.8 × 17.2 in |
| Mounting position | vertical |

Floating switch for low-level monitoring of oil

| | |
|--------------------|--|
| Type of contact | 1 change-over; 2 change-over contacts (reed contacts) |
| Switching voltage | max. 230 V AC, 230 V DC |
| Switching current | max. 0.8 A; 1.0 A |
| Switching capacity | max. 60 VA, 40 W ¹⁾ |
| Type of enclosure | IP 65 |

¹⁾ Take appropriate measures to protect contacts when switching inductive loads



NOTE

Further technical information, technical drawings, accessories, spare parts or product function descriptions available on SKF.com/lubrication:

1-1202-EN, 951-170-002 EN

Pump unit

MFE

MFE pump units for oil

| Order number | Reservoir Capacity | | Material | Design ¹⁾ |
|---------------------------|--------------------|-----|----------|--|
| | l | gal | | |
| MFE5-K3-2+299 | 3 | 0.8 | Plastic | CE basic version without level monitoring |
| MFE5-KW3-2+299 | 3 | 0.8 | Plastic | CE basic version with min. fill level switch |
| MFE5-KW3-2-S4+299 | 3 | 0.8 | Plastic | CE basic version with min. fill level switch incl. pre-warning |
| MFE5-KW3-S37+1GD | 3 | 0.8 | Plastic | UL/CSA version with fill level monitoring incl. min. fill level pre-warning |
| MFE5-KW3-S24+MGP | 3 | 0.8 | Plastic | CE version with 6 pin Harting plug with fill level monitoring incl. min. fill level pre-warning |
| MFE5-K6+299 | 6 | 1.6 | Plastic | CE basic version without level monitoring |
| MFE5-KW6+299 | 6 | 1.6 | Plastic | CE basic version with min. fill level switch |
| MFE5-KW6-S1+299 | 6 | 1.6 | Plastic | CE basic version with min. fill level switch incl. pre-warning |
| MFE5-KW6-S42+1GD | 6 | 1.6 | Plastic | UL/CSA version with fill level monitoring incl. min. fill level pre-warning |
| MFE5-KW6-S102+1FW | 6 | 1.6 | Plastic | CCC version with fill level monitoring incl. min. fill level pre-warning |
| MFE5-KW6-S33+MGP | 6 | 1.6 | Plastic | CE version with 6 pin Harting plug with fill level monitoring incl. min. fill level pre-warning |
| MFE5-B3-2+299 | 3 | 0.8 | Metal | CE basic version without level monitoring |
| MFE5-BW3-2+299 | 3 | 0.8 | Metal | CE basic version with min. fill level switch |
| MFE5-BW3-2-S28+299 | 3 | 0.8 | Metal | CE basic version with min. fill level switch incl. pre-warning |
| MFE5-BW3-2-S34+1GD | 3 | 0.8 | Metal | UL/CSA version with fill level monitoring incl. min. fill level pre-warning |
| MFE5-BW3-S41+MGP | 3 | 0.8 | Metal | CE version with 6 pin Harting plug with fill level monitoring incl. min. fill level pre-warning |
| MFE5-BW7+299 | 6 | 1.6 | Metal | CE basic version with min. fill level switch |
| MFE5-BW7-S22+1GD | 6 | 1.6 | Metal | UL/CSA version with fill level monitoring incl. min. fill level pre-warning |
| MFE5-BW7-S107+MGP | 6 | 1.6 | Metal | CE version with 6 pin Harting plug with fill level monitoring incl. min. fill level pre-warning |
| MFE5-BW7-S222+MGP | 6 | 1.6 | Metal | CE version incl. gauge and vent filter, with 6 pin Harting plug with fill level monitoring incl. min. fill level pre-warning |
| MFE5-BW16+299 | 15 | 4 | Metal | CE basic version with min. fill level switch incl. pre-warning |
| MFE5-BW16-S145+1GD | 15 | 4 | Metal | UL/CSA version with fill level monitoring incl. min. fill level pre-warning |
| MFE5-BW16-S96+MGP | 15 | 4 | Metal | CE version with 6 pin Harting plug with fill level monitoring incl. min. fill level pre-warning |
| MFE5-BW16-S222+MGP | 15 | 4 | Metal | CE version incl. gauge and vent filter, with 6 pin Harting plug with fill level monitoring incl. min. fill level pre-warning |
| MFE5-BW30+299 | 30 | 8 | Metal | CE basic version with min. fill level switch |
| MFE5-BW30-S30+29E | 30 | 8 | Metal | CE basic version with min. fill level switch incl. pre-warning |
| MFE5-BW30-S35+MGP | 30 | 8 | Metal | CE version with 6 pin Harting plug with fill level monitoring incl. min. fill level pre-warning |
| MFE5-BW30-S222+MGP | 30 | 8 | Metal | CE version incl. gauge and vent filter, with 6 pin Harting plug with fill level monitoring incl. min. fill level pre-warning |

¹⁾ MFE5 stands for 0.5 liters/min at 50hz; 0.6 l/min at 60 Hz. Further designs are available on request.

MFE pump units for fluid grease

| Order number | Reservoir Capacity | | Material | Design ¹⁾ |
|--------------------------|--------------------|-----|----------|---|
| | l | gal | | |
| MFE2-K3-2+299 | 3 | 0.8 | Plastic | CE basic version without level monitoring |
| MFE2-K3F-2+299 | 3 | 0.8 | Plastic | CE basic version with min. fill level switch |
| MFE2-KW3F-S13+1GD | 3 | 0.8 | Plastic | UL/CSA version with fill level monitoring incl. min. fill level pre-warning |
| MFE2-KW3F-S9+MGP | 3 | 0.8 | Plastic | CE version with 6 pin Harting plug with fill level monitoring incl. min. fill level pre-warning |
| MFE2-K6F+299 | 6 | 1.6 | Plastic | CE basic version without level monitoring |
| MFE2-K6F-S2+299 | 6 | 1.6 | Plastic | CE basic version with min. fill level switch |
| MFE2-KW6F-S1+299 | 6 | 1.6 | Plastic | CE basic version with min. fill level switch incl. pre-warning |
| MFE2-KW6F-S37+1GD | 6 | 1.6 | Plastic | UL/CSA version with fill level monitoring incl. min. fill level pre-warning |
| MFE2-KW6F-S20+MGP | 6 | 1.6 | Plastic | CE version with 6 pin Harting plug with fill level monitoring incl. min. fill level pre-warning |

¹⁾ MFE2 stands for 0.2 liters/min at 50hz; 0.24 l/min at 60hz. Further designs are available on request.



Overview of grease pumps and pump units

Manually operated pump units

| Product | Lubricant NLGI | | | Metering quantity max. | | Operating pressure max. ¹⁾ | | Reservoir | | Metering device category ²⁾ | | | | Piston | Page |
|--------------|----------------|---|---|-------------------------|-------------------------|---------------------------------------|------|-----------|-----|--|---|---|---|-----------------|------|
| | 0 | 1 | 2 | cm ³ /stroke | in ³ /stroke | bar | psi | kg | lib | 4 | 5 | 6 | 7 | | |
| 83817 | • | • | • | 1,6 | 0.09 | 240 | 3500 | 0,5 | 1 | – | • | • | • | multiple stroke | 48 |
| 1810 | • | • | • | 2,6 | 0.16 | 240 | 3500 | 2,3 | 5 | – | • | • | • | multiple stroke | 49 |

¹⁾ Select the correct fittings, adjust the operating pressure to fit the pressure range of the selected metering devices.
²⁾ Single-line metering devices are classified into categories according to their vent pressure in ascending order. Choosing the correct category guarantees the proper functioning of the lubrication system.

Air-operated pump units

| Product | Lubricant NLGI | | | Metering quantity max. | | Operating pressure max. ¹⁾ | | Reservoir | | Metering device category ²⁾ | | | | Piston | Page |
|---------------------|----------------|---|---|-------------------------|-------------------------|---------------------------------------|-------|---------------|-------------------|--|---|---|---|---------------|------|
| | 0 | 1 | 2 | cm ³ /stroke | in ³ /stroke | bar | psi | kg | lib | 4 | 5 | 6 | 7 | | |
| 40PGA | • | • | • | 40 | 2.44 | 150 | 2 175 | 1,7; 2; 4; 10 | 3.7; 4.4; 8.8; 22 | – | • | • | • | single stroke | 50 |
| 82886, 83886 | • | • | • | 7,4 | 0.45 | 240 | 3 500 | 0,5; 2,0 | 1; 4,4 | – | • | • | • | single stroke | 52 |
| 82653/55 | • | • | • | 22,9 | 1.39 | 240 | 3 500 | 2,0 | 4.5 | – | • | • | • | single stroke | 54 |
| 83800/34 | • | • | • | 35,2 | 2.15 | 240 | 3 500 | 2,0 | 4.5 | – | • | • | • | single stroke | 54 |
| 83167 | • | • | • | 197 | 12 | 240 | 3 500 | 5,0 | 11 | – | • | • | • | reciprocating | 55 |
| 83599 | • | • | • | 197 | 12 | 240 | 3 500 | 5,0 | 11 | – | • | • | • | reciprocating | 56 |

¹⁾ Select the correct fittings, adjust the operating pressure to fit the pressure range of the selected metering devices.
²⁾ Single-line metering devices are classified into categories according to their vent pressure in ascending order. Choosing the correct category guarantees the proper functioning of the lubrication system.
²⁾ Controller included or optional

Hydraulically operated pump units

| Product | Lubricant NLGI | | | Metering quantity max. | | Operating pressure max. ¹⁾ | | Reservoir | | Metering device category ²⁾ | | | | Piston | Page |
|---------------------|----------------|---|---|-------------------------|-------------------------|---------------------------------------|-------|-----------|--------|--|---|---|---|---------------|------|
| | 0 | 1 | 2 | cm ³ /stroke | in ³ /stroke | bar | psi | kg | lib | 4 | 5 | 6 | 7 | | |
| BPH | • | • | • | 30 | 1.83 | 120 | 1 740 | – | – | – | • | • | • | reciprocating | 59 |
| HG 1000 | • | • | – | 1 000 | 61.02 | 150 | 2 176 | 1,0 | 2.2 | • | • | – | – | single stroke | 57 |
| HG 2000 | • | • | – | 2 000 | 122 | 150 | 2 176 | 2,0 | 4.4 | • | • | – | – | single stroke | 57 |
| 84944, 84961 | • | • | • | 180 | 11 | 206 | 3 000 | 30 | 60 | – | • | • | • | reciprocating | 60 |
| 84960, 84962 | • | • | • | 180 | 11 | 206 | 3 000 | – | – | – | • | • | • | reciprocating | 61 |
| FlowMaster | • | • | • | 737 | 45 | 206 | 3 000 | 16–180 | 35–400 | – | • | • | • | reciprocating | 62 |

¹⁾ Select the correct fittings, adjust the operating pressure to fit the pressure range of the selected metering devices.
²⁾ Single-line metering devices are classified into categories according to their vent pressure in ascending order. Choosing the correct category guarantees the proper functioning of the lubrication system.

Air-operated barrel pumps

| Product | Lubricant NLGI | | | Metering quantity max. | | Operating pressure max. ¹⁾ | | Reservoir | | Metering device category ²⁾ | | | | Piston | Page |
|---------------------|----------------|---|---|------------------------|----------------------|---------------------------------------|-------|---------------------|----------------------|--|---|---|---|---------------|------|
| | 0 | 1 | 2 | cm ³ /min | in ³ /min | bar | psi | kg | lb | 4 | 5 | 6 | 7 | | |
| MPB | • | • | • | 305 | 18.61 | 300 | 4 350 | 18; 50; 180 | 40; 120; 400 | – | • | • | • | reciprocating | 64 |
| 84050/ 85460 | • | • | • | 492 | 30 | 240 | 3 500 | 27 | 60 | – | • | • | • | reciprocating | 66 |
| 282288 | • | • | • | 492 | 30 | 240 | 3 500 | 55 | 120 | – | • | • | • | reciprocating | 67 |
| FlowMaster | • | • | • | 737 | 45 | 206 | 3 000 | 16; 27; 41; 54; 180 | 35; 60; 90; 120; 400 | – | • | • | • | reciprocating | 74 |

¹⁾ Select the correct fittings, adjust the operating pressure to fit the pressure range of the selected metering devices.
²⁾ Single-line metering devices are classified into categories according to their vent pressure in ascending order. Choosing the correct category guarantees the proper functioning of the lubrication system.



Overview of grease pumps and pump units

Electrically operated pump units

| Product | Lubricant NLGI | | | Metering quantity max. | | Operating pressure max. | | Reservoir | | Metering device category ¹⁾ | | | | Voltage | Page | |
|------------------|----------------|---|---|------------------------|----------------------|-------------------------|-----|-----------|-------------------------------|--|---|---|---|---------|--------------------------|----|
| | 0 | 1 | 2 | cm ³ /min | in ³ /min | bar | psi | kg | lb | 4 | 5 | 6 | 7 | | | |
| P603S | 2) 3) | • | • | • | 12 | 0.7 | 300 | 4 350 | 4; 8; 10; 15; 20; 30; 40; 100 | 8.8; 18; 22; 33; 44; 66; 88; 220 | - | • | • | • | 12/24 V DC; 120/230 V AC | 68 |
| Minilube | 2) | • | • | • | 13 | 0.8 | 250 | 3 625 | 2 | 4.4 | - | • | • | • | 12/24 V DC | 70 |
| KFG | | • | • | • | 15 | 0.9 | 300 | 4 350 | 2; 4; 6; 8; 10; 12; 15; 20 | 4.4; 8.8; 13; 18; 22; 26; 33; 44 | - | • | • | • | 12/24 V DC; 90-264 V AC | 72 |
| Multilube | 2) | • | • | - | 16 | 0.976 | 200 | 2 900 | 4; 10 | 8.8; 22 | - | • | • | • | 24 V DC; 115/230 V AC | 74 |
| P653S | 2) 3) | • | • | • | 24,6 | 1.5 | 317 | 4 600 | 4; 8; 10; 15; 20; 30; 40; 100 | 8.8; 18; 22; 33; 44; 66; 88; 220 | - | • | • | • | 24 V DC; 120/230 V AC | 76 |

1) Select the recommended fittings, adjust the pump pressure within the recommended metering device pressure range
 2) Controller included or optional
 3) Stainless steel or C5M available

Electrically operated barrel pumps

| Product | Lubricant NLGI | | | Metering quantity max. | | Operating pressure max. | | Reservoir | | Metering device category ¹⁾ | | | | Voltage | Page | |
|-------------------|----------------|---|---|------------------------|----------------------|-------------------------|-----|-----------|-----------------------------|--|---|---|---|---------|--------------------------|----|
| | 0 | 1 | 2 | cm ³ /min | in ³ /min | bar | psi | kg | lb | 4 | 5 | 6 | 7 | | | |
| E-PUMP | | • | • | • | 55 | 3.35 | 240 | 3 480 | 18, 50, 180 | 40; 120; 400 | - | • | • | • | 20-32 V DC | 78 |
| FK | 2) | • | • | • | 74 | 4.5 | 400 | 5 800 | 15; 30; 60 | 22; 66; 132 | - | • | • | • | 3 phase drive | 80 |
| FlowMaster | | • | • | • | 103 | 6.3 | 345 | 5 000 | 16; 25; 28; 35; 40; 55; 180 | 35; 55; 60; 78; 90; 120; 400 | - | • | • | • | 12/24 V DC; 120-460 V AC | 82 |

1) Select the recommended fittings, adjust the pump pressure within the recommended metering device pressure range
 2) Controller included or optional
 3) Stainless steel or C5M available

Pump unit

83817



Description

This manual pump unit has a metal reservoir and a spring-loaded follower. The indicator pin in the pump base shows when 172 bar (2 500 psi) system operating pressure has been achieved.

Features and benefits

- Number of strokes dependent on connected lubrication points and their dosage
- Metal reservoir with spring-loaded follower also suitable for replaceable 400 g grease cartridges
- Simple handling
- Low-cost, efficient method of lubricant distribution
- Pump base with built-in check vent valve and indicator pin for visual control of max. or vent pressure
- Vents when handle is pushed all the way back
- Two different filling couplers available
- Suitable for use with grease metering devices of category 5, 6 and 7 (→ page 123)

Applications

- Construction machinery
- Agriculture



Technical data

| | |
|-----------------------|---|
| Order number | 83817 |
| Function principle | manually operated piston pump |
| Outlets | 1 |
| Metering quantity | 1,6 cm ³ /stroke, 0.10 in ³ /stroke |
| Lubricant | grease NLGI 0, 1, 2 |
| Operating temperature | -20 to +65 °C, -4 to +149 °F |
| Operating pressure | min. 82 bar, 1 200 psi max. 240 bar, 3 500 psi |
| Reservoir | 0,5 kg, 1 lb |
| Material | steel, brass, copper, polyurethane, nitrile |
| Filling method | 0,4 kg, 14.5 oz, grease cartridge/bulk fill |
| Connection outlet | 1/8 NPTF (F) |
| Dimensions | 387 × 127 × 141 mm 15.25 × 5 × 5.625 in |
| Mounting position | vertical or horizontal |



NOTE

Further technical information, technical drawings, accessories, spare parts or product function descriptions available on SKF.com/lubrication.

Pump unit

1810



Description

The Model 1810 pump unit features a translucent reservoir with spring-loaded follower. The indicator pin in the pump base shows when 172 bar (2 500 psi) system operating pressure has been achieved. It can be refilled via the included fitting using the Model 81834 filler pump or other manual pumps equipped with a Model 645006 coupler.

Features and benefits

- Number of strokes dependent on connected lubrication points and their dosage
- Reservoir with spring-loaded follower
- Simple handling
- Low-cost, efficient method of lubricant distribution
- Pump base with built-in check vent valve and indicator pin for visual control of max. or vent pressure
- Releases pressure on the lubricant line when handle is pushed all the way back
- Two different filling couplers available
- Suitable for use with grease metering devices of category 5, 6 and 7 (→ page 123)

Applications

- Construction machinery
- Agriculture

Technical data

| | |
|-----------------------|---|
| Order number | 1810 |
| Function principle | manually operated piston pump |
| Outlets | 1 |
| Metering quantity | 2,6 cm ³ /stroke, 0,16 in ³ /stroke |
| Lubricant | grease NLGI 0, 1, 2 |
| Operating temperature | -20 to +65 °C; -4 to +149 °F |
| Operating pressure | min. 82 bar, 1 200 psi max. 240 bar, 3 500 psi |
| Reservoir | 2,3 kg, 5 lb |
| Material | acrylic, steel, brass, copper, polyurethane, nitrile |
| Connection outlet | 1/4 NPTF (F) |
| Dimensions | 413 × 181 × 197 mm 16.25 × 7.125 × 7.75 in |
| Mounting position | vertical or horizontal |



NOTE

Further technical information, technical drawings, accessories, spare parts or product function descriptions available on SKF.com/lubrication.

Pump unit

40PGA



Description

Pump Model 40PGA is a compact lubrication pump unit. The splash-proof pump operates pneumatically and can be controlled and monitored by the remote electric control unit ST-102 or ST-102P. The pump is available with a choice of different kind of reservoir sizes and materials, each featuring a spring-loaded intermediate piston. A low-level alarm is available in aluminum and steel version and pump is available with an integrated pressure switch.

Features and benefits

- Compact, air-operated lubrication pump unit for demanding conditions
- Part of a modular and modifiable system
- Splash-proof pump is offered with:
 - choice of four different reservoir sizes
 - spring-loaded, intermediate piston in reservoir
 - steel and aluminum reservoirs are equipped with low level alarm
 - optional an integrated pressure switch
- Mechanical relief valve
- Controlled and monitored by a remote timer continuously
- Safe and environmentally friendly
- Suitable for use with grease metering devices of category 5, 6 and 7 (→ page 123)

Applications

- Buses and trucks
- Heavy vehicles

Technical data

| | |
|------------------------------|---|
| Function principle | air operated piston pump |
| Outlet | 1 |
| Metering quantity | 40 cm ³ /stroke, 2.4 in ³ /stroke |
| Lubricant | grease NLGI 0, 1 |
| Operating temperature | -30 to +70 °C, -22 to 158 °F |
| Operating pressure | max. 150 bar; 2 175 psi |
| Actuation pressure (air) | 10 bar, 145 psi |
| Reservoir | 1,7; 2; 4 and 10 kg 3.75; 4.40; 8.82 and 22.05 lb |
| Material | stainless steel, plastic, steel and aluminum |
| Connection outlet | R 1/4 in |
| Operating voltage | 24 V |
| Transmission ratio | 16:1 |
| Protection class | IP 65 |
| Dimensions (dep. on version) | min. 270 × 320 × 180 mm max. 570 × 325 × 245 mm min. 10.63 × 12.59 × 7.0 in max. 22.44 × 12.79 × 9.65 in |
| Mounting position | vertical and horizontally |



NOTE

Further technical information, technical drawings, accessories, spare parts or product function descriptions available on SKF.com/lubrication:

11678 EN, 11390007_40PGA_01_EN

Pump unit

40PGA

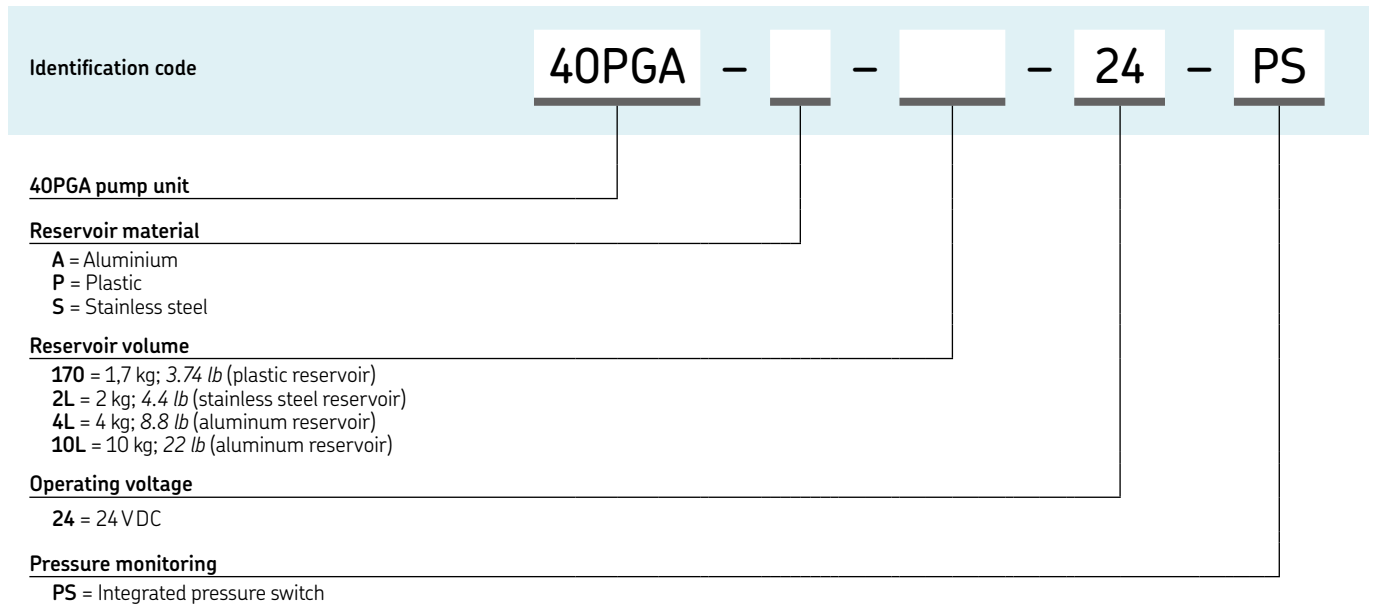

Pump unit

82886, 83668



Description

All models are air-operated, positive-displacement pumps delivering a maximum volume by means of a single stroke of the pump. Solenoid air valves and adjustable, solid-state time controls are integrated into the pump body, and translucent, acrylic reservoirs with spring-loaded followers are available in several sizes. Pump discharges lubricant on air-powered forward stroke and releases pressure on the lubricant line on spring-powered return stroke through built-in check/relief valve. Includes filler fitting for refilling reservoir with Model 81834 or other manual pump equipped with Model 645006 coupler.

Features and benefits

- Remote system components such as 3/2-way valves, adjustments for air power, and monitoring of pump and system are available separately on request
- Suitable for use with grease metering devices of category 5, 6 and 7 (→ page 123)

Applications

- Cement industry, wood-working,
- Food and beverage



Technical data

| | |
|-----------------------|---|
| Function principle | air operated piston pump (single-stroke) |
| Outlets | 1 |
| Metering quantity | 7,4 cm ³ /stroke, 0,45 in ³ /stroke |
| Lubricant | grease NLGI 0, 1, 2 |
| Operating temperature | -18 to +65 °C; 0 to +150 °F |
| Operating pressure | min. 82 bar, 1 200 psi max. 240 bar, 3 500 psi |
| Reservoir | 0,5 or 2 kg; 1 or 4.4 lb |
| Material | acrylic |
| Connection outlet | 1/4 NPTF (F) |
| Transmission ratio | 20:1 |
| Air inlet | 1/4 NPTF (F) |
| Mounting position | vertical |

Timer

| | |
|-----------------------|----------------------------------|
| On time | min. 10 sec; max. 1 min. 24 sec |
| Cycle time | min. 20 sec; max. 24 h |
| Voltage | 120 V AC, 60 Hz; 110 V AC, 50 Hz |
| Operating temperature | -23 to +65 °C; -10 to +150 °F |

NOTE

Further technical information, technical drawings, accessories, spare parts or product function descriptions available on SKF.com/lubrication.

Pump unit

82886, 83668

Order information

| Order number | Reservoir capacity | | Dimensions | |
|--------------|--------------------|-----|-----------------|------------------|
| | kg | lb | mm | in |
| 82886 | 0,5 | 1.0 | 263 × 133 × 152 | 10.4 × 5.3 × 6.0 |
| 83668 | 2,0 | 4.4 | 470 × 133 × 152 | 18.5 × 5.3 × 6.0 |

Pump unit

82653/55, 83800/34



Description

All models are air-operated, positive-displacement pumps delivering a maximum volume by means of a single stroke of the pump. Solenoid air valves and adjustable, solid-state time controls are integrated into the pump body. These pump units are designed to deliver grease to single-line metering devices and include a special high-volume refill fitting. Translucent, acrylic reservoirs with spring-loaded followers are available in several sizes. Pump uses air for forward and return stroke but dispenses lubricant on forward stroke only. Return stroke releases pressure on the lubricant line through included check/relief valve.

Features and benefits

- Remote system components such as 4/2-way valves, adjustments for air power, and monitoring of pump and system are available separately on request
- High-volume refill fitting
- Suitable for use with grease metering devices of category 5, 6 and 7 (→ page 123)

Applications

- Oil and gas industry



Technical data

| | |
|-----------------------|---|
| Function principle | air operated piston pump (single-stroke) |
| Outlets | 1 |
| Metering quantity | 22,9 to 35,2 cm ³ /stroke 1.4 to 2.15 in ³ /stroke |
| Lubricant | grease NLGI 0, 1, 2 |
| Operating temperature | -18 to +65 °C; 0 to +150 °F |
| Operating pressure | min. 82 bar, 1 200 psi max. 240 bar, 3 500 psi |
| Reservoir | 2,0 kg; 4.5 lb |
| Material | acrylic |
| Connection outlet | 1/4 NPTF (F) |
| Transmission ratio | 31:1; 25:1 |
| Air inlet | 1/4 NPTF (F) |
| Dimensions | 470 x 146 x 533 mm 18.5 x 5.75 x 20.9 in |
| Mounting position | vertical |

Timer (for 82655 and 83800 only)

| | |
|-----------------------|--------------------------------------|
| On time | min. 10 sec max. 1 minute, 24 sec |
| Cycle time | min. 20 sec max. 24 h |
| Operating voltage | 120 VAC, 60 Hz; 110 VAC, 50 Hz |
| Operating temperature | -23 to +65 °C; -10 to +150 °F |

Air consumption at 6,9 bar, 100 psi, is 0,004 M³/min, 0.15 ft³/min, per stroke

Order information

| Order number | Ratio | Metering quantity | | Designation |
|--------------|-------|-------------------------|-------------------------|--------------------|
| | | cm ³ /stroke | in ³ /stroke | |
| 82653 | 31:1 | 22,9 | 1.4 | bare pump |
| 82655 | 31:1 | 22,9 | 1.4 | pump with controls |
| 83800 | 25:1 | 35,2 | 2.15 | pump with controls |
| 83834 | 25:1 | 35,2 | 2.15 | bare pump |



NOTE

Further technical information, technical drawings, accessories, spare parts or product function descriptions available on SKF.com/lubrication.

Pump unit

83167



Description

Model 83167 is an air-operated, positive-displacement pump delivering a maximum volume by means of a single stroke of the pump. Solenoid air valves and adjustable, solid-state time controls are integrated into the pump body. This pump unit is designed to deliver grease to single-line metering devices and includes a special high-volume refill fitting. Acrylic reservoirs are available in several sizes. Model 83167 includes a transparent reservoir, spring-loaded follower, vent valve assembly and filler fitting for refilling the reservoir.

Features and benefits

- 2 1/2 inch air motor
- Vent valve assembly
- Operation by air-powered reciprocating strokes and releases pressure on the lubricant line through included check/relief valve (3-way) on air-powered return stroke
- Remote system components such as 3/2-way valves, adjustments for air power, and monitoring of pump are available separately on request
- Two different filling couplers available
- Suitable for use with metering devices of category 5, 6 and 7 (→ page 123)

Applications

- Cement industry
- Food and beverage



Technical data

| | |
|-----------------------|---|
| Order number | 83167 |
| Function principle | air operated reciprocating piston pump |
| Outlets | 1 |
| Metering quantity | 197 cm ³ /stroke, 12 in ³ /stroke |
| Lubricant | grease NLGI 0, 1, 2 |
| Operating temperature | -35 to +104 °C; -30 to +220 °F |
| Operating pressure | min. 82 bar, 1 200 psi max. 240 bar, 3 500 psi |
| Transmission ratio | 40:1 |
| Reservoir | 5,0 kg; 11.0 lb |
| Material | acrylic, nitrile, neoprene, steel, aluminum, zinc |
| Connection outlet | 3/4 NPTF (F) |
| Air inlet | 1/8 NPTF (F) |
| Dimensions | 413 × 229 × 571,5 mm 16.25 × 9.0 × 22.5 in |
| Mounting position | vertical |

Pump requires 3-way air valve
Air consumption at 6,9 bar, 100 psi, is 0,004 M³/min, 0.15 ft³/min, per stroke



NOTE

Further technical information, technical drawings, accessories, spare parts or product function descriptions available on SKF.com/lubrication.

Pump unit

83599



Description

Model 83599 is an air-operated, positive-displacement pump delivering a maximum volume by means of a single stroke of the pump. Solenoid air valves and adjustable, solid-state time controls are integrated into the pump body. The pump is designed to deliver grease to single-line metering devices and includes a special high-volume refill fitting. Acrylic reservoirs are available in several sizes. Model 83599 is similar to Model 83167 except that it includes a base-mounting kit and metal reservoir with indicator rod for visual check of grease level. The reservoir includes a spring-loaded follower.

Features and benefits

- 2 1/2 inch air motor
- Reservoir with spring-loaded follower and indicator rod for visual check of grease level
- Vent valve assembly
- Base mounting kit
- Operation by air-powered reciprocating strokes and releases pressure on the lubricant line through included check/relief valve (3-way) on air-powered return stroke
- Remote system components such as 3/2-way valves, adjustments for air power, and monitoring of pump are available separately on request
- Two different filling couplers available
- Suitable for use with grease metering devices of category 5, 6 and 7 (→ page 123)

Applications

- Machine tools
- Industrial machinery



Technical data

| | |
|-----------------------|---|
| Order number | 83599 |
| Function principle | air operated, reciprocating piston pump |
| Outlets | 1 |
| Metering quantity | 197 cm ³ /stroke, 12 in ³ /stroke |
| Lubricant | grease NLGI 0, 1, 2 |
| Operating temperature | -34 to +121 °C; -30 to +250 °F |
| Operating pressure | min. 82 bar, 1 200 psi max. 240 bar, 3 500 psi |
| Transmission ratio | 40:1 |
| Reservoir | 5,0 kg; 11.0 lb |
| Material | acrylic, nitrile, neoprene, steel, aluminum, zinc |
| Connection outlet | 3/4 NPTF (F) |
| Air inlet | 1/4 NPTF (F) |
| Dimensions | 462 × 229 × 697 mm 18.19 × 9.0 × 27.44 in |
| Mounting position | vertical |

Pump requires 3-way air valve
Air consumption at 6,9 bar, 100 psi, is 0,004 M³/min, 0.15 ft³/min, per stroke



NOTE

Further technical information, technical drawings, accessories, spare parts or product function descriptions available on SKF.com/lubrication.

Pump unit

HG 1000, HG 2000



Description

The hydraulic lubricator HG is an lubrication system developed for a cost-efficient automatic lubrication in machines and implements having a hydraulic circuit. With the help of the hydraulic lubricator, centralized automatic lubrication can be adapted to such units as dismantlable hoists, small lift trucks and rear lifts of vehicles.

Features and benefits

- Simple piston pump utilizes self-relieving hydraulic lines
- Provides cost-efficient automatic lubrication
- Suitable for use in vehicles or machines having a safe hydraulic circuit that is not constantly in operation
- Pressure rise and fall operation in the pump is activated by powering-on and powering-off the adapted hydraulic circuit
- Pressure rise and fall operation in the lube line, as well as the amount of lube remaining, can be verified from the pressure gauge of the pump unit
- Optional low-level limit alarm can be indicated by a buzzer or indicator lamp 12 or 24 VDC
- Filling coupler with filter
- Suitable for use with metering devices of category 4 and 5

Applications

- Vehicles
- Machines
- Dismountable hoists
- Small lift trucks
- Rear lifts of trucks

Technical data

| | |
|----------------------------|---|
| Function principle | hydraulically operated, piston pump |
| Outlets | 1 |
| Metering quantity: | |
| HG 1000 | max. 1 000 cm ³ /stroke; 61 in ³ /stroke |
| HG 2000 | max. 2 000 cm ³ /stroke; 122 in ³ /stroke |
| Lubricant | grease NLGI 0, 1 |
| Operating temperature | -25 to +80 °C; -13 to +176 °F |
| Operating pressure | min. 50 bar, 725 psi max. 150 bar, 2 176 psi |
| Transmission ratio | 1:1 |
| Reservoir | 1 and 2 kg; 2.2 and 4.4 lb |
| Material (reservoir) | steel |
| Grease outlet connection | R 3/4 in ZN; main hose Ø 8 mm, 0.341 in |
| Hydraulic inlet connection | R 3/4 in ZN; main hose Ø 8 mm, 0.341 in |
| Operating voltage | 12 or 24 VDC |
| Dimensions: | |
| HG 1000 | 345 × 100 × 100 mm; 13.58 × 3.94 × 3.94 in |
| HG 2000 | 520 × 100 × 100 mm; 20.47 × 3.94 × 3.94 in |
| Mounting position | vertical or horizontal |

Order information

| Order number | Designation | Weight | |
|--------------|--------------|--------|------|
| | | kg | lb |
| 11390060 | HG-1000 Pump | 7,2 | 15.8 |
| 11390070 | HG-2000 Pump | 10,2 | 22.4 |



NOTE

Further technical information, technical drawings, accessories, spare parts or product function descriptions available on SKF.com/lubrication.

Pump unit

BPH



Description

The hydraulically operated barrel pump series BPH offers all features needed to run the machine without unplanned interruptions. Constructed of heavy-duty material, the pump works reliable in demanding applications, including excavators, loaders, haul trucks and other heavy machinery in construction and mining environment. Featuring a fully encased pump head, damages during tough operation become less likely. The compact design allows to mount the pump even in applications, where space is limited. While hindering fluids to leak, the three-sealing-package provides the extra step to safe and reliable operation. In addition, it minimizes the risk of contamination of hydraulic oils as well as environmental concerns. Flow rate and reverse pressure can be adjusted to fit the application needs. Built-in sensors monitor oil pressure, temperature and piston movement helping to avoid malfunction prior the event.

Features and benefits

- Innovative sealing concept to avoid hydraulic oil and lubrication grease leakage
- Three possible outlet directions, front, left and right
- Compact and robust design for demanding applications
- Optional monitoring sensors for increased reliability
- Suitable for use with grease metering devices of category 5, 6 and 7 (→ page 123)

Applications

- Construction machinery
- Mining machinery



Technical data

| | |
|---|---|
| Order numbers: | |
| BPH30 pump basic | BPH30-3001AB-VAOM |
| BPH30 pump with sensors | BPH30-3101AB-VAOM |
| Function principle | hydraulically operated barrel pump |
| Outlets | 1 |
| Metering quantity | 30 cm ³ /stroke; 1.83 in ³ /stroke 360 cm ³ /min; 22 in ³ grease NLGI 0, 1, 2 |
| Lubricant | grease NLGI 0, 1, 2 |
| Operating temperature | -40 to +80 °C; -40 to +176 °F |
| Operating back pressure | max. 320 bar, 4 642 psi |
| Transmission ratio | min. 10:1 |
| Required viscosity of the hydraulic oil | 13 mm – 380 mm ² /s |
| Nominal oil pressure | 35–120 bar; 508–1 740 psi |
| Suitable barrels | 208 l; 55 gal |
| Material | steel, FKM (FPM), NBR |
| Corrosion class | C3 |
| Connection outlet | 3/4 NPTF (F) or M27×2 |
| Hydraulic oil inlet | G 3/8 |
| Protection class | IP 65 |
| Dimensions | 245 × 155 × 1 260 mm 9.6 × 6.1 × 50 in |
| Mounting position | upright |

Pump requires 3-way air valve
Air consumption at 6,9 bar, 100 psi, is 0,004 M³/min, 0.15 ft³/min, per stroke



NOTE

Further technical information, technical drawings, accessories, spare parts or product function descriptions available on SKF.com/lubrication.

PUB LS/P2 19079 EN, 951-171-060-EN

Pump unit

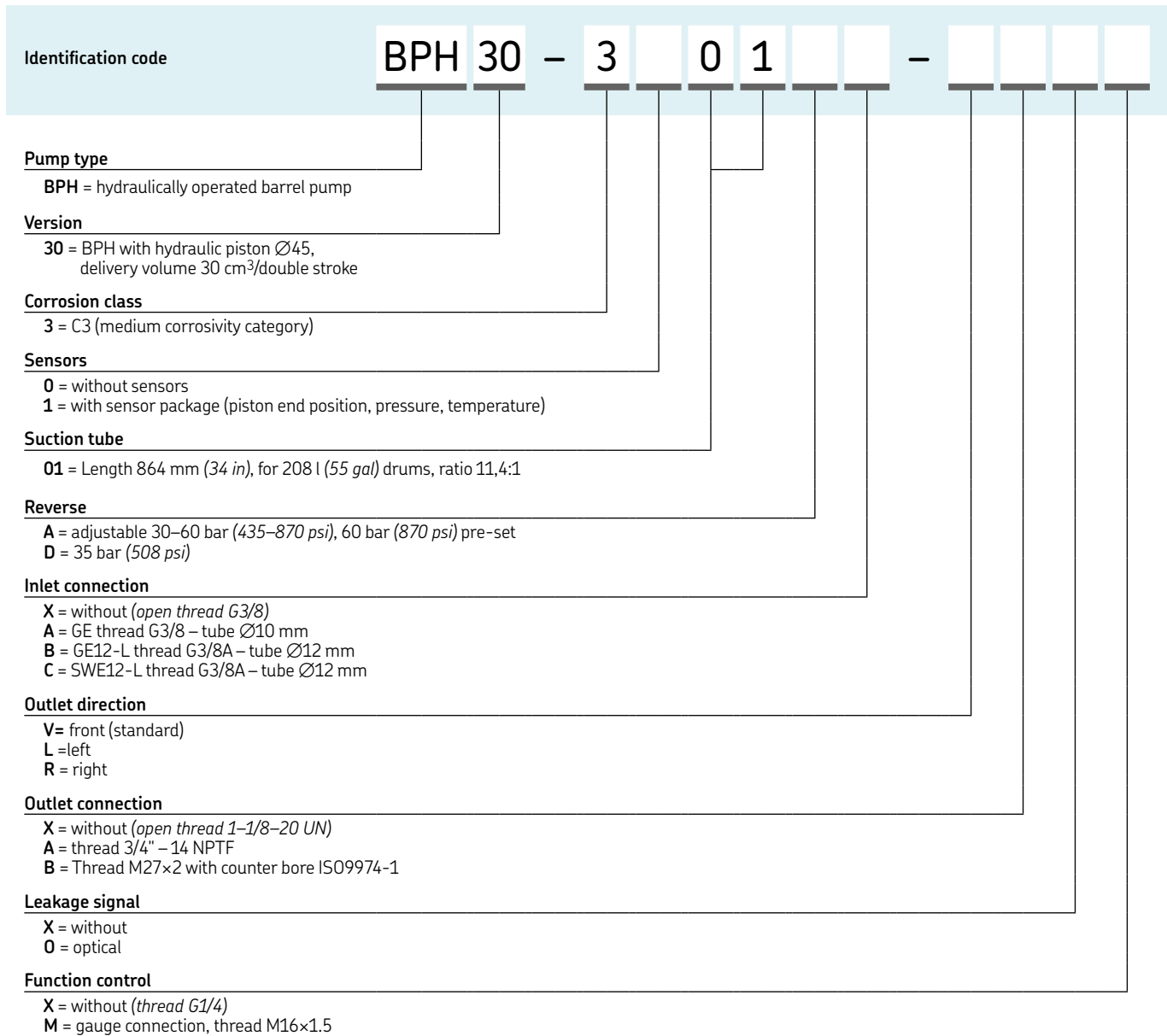
BPH



| Order information | |
|--|-----------------------------------|
| Order number | Description |
| BPH30-3001AB-VAOM ¹⁾ | BPH30 pump, basic without sensors |
| BPH30-3101AB-VAOM ¹⁾ | BPH30 pump, basic with sensors |

¹⁾ Basic pump versions include:

- Corrosion class C3
- Suction tube 01 for drum size 55 gal / 208 liter
- Adjustable reverse pressure 30–60 bar (435–870 psi)
- Inlet connection GE12-L thread G3/8A – tube Ø12
- Front outlet direction
- Outlet connection thread 3/4" – 1/4 NPTF
- Optical leakage signal
- Function monitoring control with pressure gauge

| Spare parts | |
|----------------------|---------------------------------------|
| Order number | Description |
| 4090-00000011 | Housing |
| 5090-00000001 | Pump tube |
| 5090-00000013 | Pressure control valve |
| 2350-00000077 | Flow control valve |
| 6640-00000046 | Cable harness |
| 5090-00000012 | Hydraulic piston Ø45 mm complete |
| 5090-00000005 | Sealing housing |
| 5090-00000011 | Leakage monitoring |
| 6640-00000064 | Proximity switch 10–30 V DC with plug |
| 2340-00000083 | Pressure sensor 10–30 V DC |
| 6640-00000065 | Temperature probe PT100 with plug |

Pump unit

84944, 84961



Description

Models 84944 and 84961 are pumping systems designed to operate centralized lubrication systems that utilize single-line, parallel grease metering components. The pump is double acting, dispensing lubricant on both the up and down strokes. These units are designed for off-road equipment that utilizes 24 VDC power sources. These units can be used in conjunction with:

Models 244270 (not potted) or 249605 (potted) cycle timers; Model 84944 hydraulically operated pump with 60 lb metal reservoir and vent valve (basic pump); and Model 84961 basic pump (similar to Model 84944 but without reservoir or vent valve). These products include a pump and hydraulic control.

Features and benefits

- Robust design
- Pump operates by an electrical signal
- Supplied with metal reservoir with removable cover for easy filling
- Includes a hydraulic operated solenoid vent valve 24 VDC
- Includes a hydraulic pressure reduction valve rated 4 to 55 bar (60 to 800 psi) output
- Bulk filling method
- Suitable for use with grease metering devices of category 5, 6 and 7 (→ page 123)

Applications

- Construction machinery
- Heavy machines
- Vehicles

Technical data

| | |
|--------------------------|---|
| Order number | 84944 84961 |
| Function principle | hydraulically operated, double-acting piston pump |
| Outlets | 1 |
| Metering quantity | 180 cm ³ /stroke, 11 in ³ /stroke |
| Lubricant | grease NLGI 0, 1, 2 |
| Operating temperature | -40 to +57 °C; -40 to +135 °F |
| Fluid inlet temperature | max. +99 °C; +210 °F |
| Hydraulic inlet pressure | min. 20 bar, 300 psi max. 205 bar, 3 000 psi |
| Pressure ratio | 16:1 |
| Reservoir | 27,0 kg; 60.0 lb |
| Material | steel, brass, copper, polyurethane, nitrile |
| Connection outlet | 3/4 NPTF (M) |
| Hydraulic inlet/outlet | 1/4 NPTF (M) |
| Flow rate | at 30 cycles/min: 3,8 l/min, 1.0 gal/min |
| Operating voltage | 24 VDC |
| Dimensions: | |
| 84944 | 381 × 495,3 × 889 mm 15 × 19,5 × 35 in |
| 84961 | 76 × 177,8 × 866,8 mm 3 × 7 × 34.125 in |
| Mounting position | vertical |
| Cycle timer | |
| Voltage | 24 VDC |
| Cycle rate per min | min. 6, max. 60 |



NOTE

Further technical information, technical drawings, accessories, spare parts or product function descriptions available on SKF.com/lubrication.

Pump unit

84960, 84962



Description

Models 84960 and 84962 are pumps designed to operate centralized lubrication systems that utilize single-line parallel grease metering components. The pumps are double acting, dispensing lubricant on both the up and down strokes. These units are designed for off-road equipment that utilizes 24 VDC power sources. These units can be used in conjunction with Models 244270 (not potted) or 249605 (potted) cycle timers. Included hydraulic solenoids require 24 VDC. Model 84960 is a hydraulic pump for use with U.S. standard 120 lb refinery drums. System components (pump, vent assembly, drum cover and follower plate) must be ordered separately. Model 84962 is a hydraulic pump for custom lubricant container installations. Pump length is sized for U.S. standard 400 lb refinery drum depth.

Features and benefits

- For use with U.S. standard 54 kg (120 lb) refinery drum
- Robust
- Includes a hydraulic pressure reduction valve rated 4 to 55 bar (60 to 800 psi) output
- System components (pump, vent valve assembly, drum cover and follower plate) must be ordered separately
- Suitable for use with grease metering devices of category 5, 6 and 7 (→ page 123)

Applications

- Mining industry
- Cement industry

Technical data

| | |
|--------------------------|---|
| Order number | 84960 84962 |
| Function principle | hydraulically operated, double-acting piston pump |
| Outlets | 1 |
| Metering quantity | 180 cm ³ /stroke, 11 in ³ /stroke |
| Lubricant | grease NLGI 0, 1, 2 |
| Operating temperature | -40 to +57 °C; -40 to +135 °F |
| Fluid inlet temperature | max. +99 °C; +210 °F |
| Hydraulic inlet pressure | min. 20 bar, 300 psi max. 205 bar, 3 000 psi |
| Pressure ratio | 16:1 |
| Material | steel, brass, copper, polyurethane, nitrile |
| Connection outlet | 3/4 NPTF (F) |
| Hydraulic inlet/outlet | 1/4 NPTF (M) |
| Flow rate | at 30 cycles/min: 3,8 l/min, 1.0 gal/min |
| Operating voltage | 24 VDC |
| Dimensions: | |
| 84960 | 76 × 177,8 × 1 083 mm 3 × 7 × 42.625 in |
| 84962 | 76 × 177,8 × 862 mm 3 × 7 × 33.94 in |
| Mounting position | vertical |
| Cycle timer | |
| Voltage | 24 VDC |
| Cycle rate per min | min. 6, max. 60 |

Pumps require a timed electrical signal to operate. Use 244270 (not potted) or 249605 (potted) cycle timer. Included hydraulic solenoids require 24 VDC. All pumps have a hydraulic pressure-reducing valve rated for 4 to 55 bar, 60 to 800 psi, output. Maximum input is 207 bar (3 000 psi).

NOTE

Further technical information, technical drawings, accessories, spare parts or product function descriptions available on SKF.com/lubrication.

Pump unit

FlowMaster, hydraulic



Description

High-performance FlowMaster hydraulic pumps combine rotary-driven pump motors with reciprocating pump tubes and flexible control features that perform in desert heat and arctic cold. The integrated control manifold adjusts the amount of lubricant and operating pressure. The pump's output is adjustable from 115 to 737 cm³/min (7 to 45 in³/min). FlowMaster pumps are optionally available incl. mechanical overflow prevention system to improve worker and environmental safety by helping to prevent hazards associated with reservoir overfilling.

Features and benefits

- Increases pump life and simplifies pump installation, operation and service
- Pump and reservoir combination models are automatically level-sensor and shut-off system ready
- Premium-choice pump for single-line parallel lubrication systems
- Flexible ranges of use pump only or pump and bucket with follower low- and high-level detection
- Optional overflow prevention system to improve worker safety and minimize environmental concerns caused by overfilling
- For desert heat and cold climates
- Suitable for use with grease metering devices of category 5, 6 and 7 (→ page 123)

Applications

- Construction machinery
- Mining and mineral processing
- Automotive industry
- Food and beverage
- Paper mills
- Steel mills

Technical data

| | |
|--|---|
| Function principle | hydraulically operated piston pump |
| Outlets | 1 |
| Metering quantity | adjustable 115 to 737 cm ³ /min 7 to 45 in ³ /min |
| Lubricant | grease NLGI 0, 1, 2 |
| Hydraulic fluid temperature | max. +93 °C, +200 °F |
| Operating temperature | -29 to +65 °C, -20 to +150 °F |
| Operating inlet pressure | 20 to 32 bar, 300 to 420 psi |
| Supply inlet pressure | max. 200 bar, 3 000 psi |
| Reservoir | 16; 27; 41; 54; 180 kg 35; 60; 90; 120; 400 lb |
| Material | fluoroelastomer, polyurethane, steel, aluminum zinc casting |
| Connection outlet | 1/4 NPTF |
| Hydraulic inlet flow | max. 28 l/min, 7 gal/min |
| Solenoid valve coil | 24 VDC |
| Hydraulic inlet port | SAE 4 |
| Tank return port | SAE 6 |
| Transmission ratio with manifold | 9:1 at low inlet pressure (20 to 25 bar, 300 to 350 psi) and flow (below 7 lpm, 2 gpm); approaches 11:1 at higher inlet pressure and flow |
| Dimensions: | |
| Pump, dip tube length | min. 348 mm; 13.7 in max. 864 mm; 34.02 in |
| Basic pump | min. 610 × 231 × 291 mm max. 1 126 × 231 × 291 mm min. 24 × 9 × 11.5 in max. 44.3 × 9 × 11.5 in |
| Pumps with bucket, follower and vent valve | min. 633 × 496 mm max. 1 155 × 496 mm min. 24.9 × 19.5 in max. 45.44 × 19.5 in |
| Mounting position | vertical |

Pump unit

FlowMaster, hydraulic

Order information

| Order number | Description | Reservoir capacity | | Solenoid manual override | Adjustable flow control | Adjustable pressure control |
|-----------------|---|--------------------|--------|--------------------------|-------------------------|-----------------------------|
| | | kg | lb | | | |
| 85722 | FlowMaster pump and bucket with follower and low-level detection | 27 | 60 | – | • | • |
| 85723 | FlowMaster pump and reservoir | 27 | 60 | – | – | – |
| 85724 | FlowMaster pump and reservoir | 27 | 60 | – | – | – |
| 85725 | FlowMaster pum and bucket with follower and low-level detection | 41 | 90 | – | • | • |
| 85726 | FlowMaster pum and bucket | 41 | 90 | • | – | – |
| 85727 | FlowMaster pum and bucket with follower, low- and high-level detection | 54 | 120 | – | • | • |
| 85722MS0 | FlowMaster pump and bucket with follower and low-level detection, mechanical shut-off device and reservoir | 27 | 60 | – | • | • |
| 85725MS0 | FlowMaster pump and bucket with follower and low-level detection, mechanical shut-off device and reservoir | 41 | 90 | – | • | • |
| 85727MS0 | FlowMaster pump and bucket with follower, low- and high-level detection, mechanical shut-off device and reservoir | 54 | 120 | – | • | • |
| 85731 | FlowMaster pump only | 16 | 35 | – | • | • |
| 85732 | FlowMaster pump only | 27 | 60 | – | • | • |
| 85733 | FlowMaster pump only | 54/41 | 120/90 | – | • | • |
| 85734 | FlowMaster pump only | 180 | 400 | – | • | • |
| 85735 | FlowMaster pump only | 27 | 60 | – | – | – |
| 85741 | FlowMaster pump only | 27 | 60 | • | – | – |
| 85742 | FlowMaster pump only | 54/41 | 120/90 | • | – | – |

Accessories

Drum cover, follower assembly, vent cvalves etc.

| Order number | Description | Reservoir capacity | |
|--------------------|----------------------------|--------------------|----------|
| | | gal | lb |
| 84616 | drum cover | 18 | 120 |
| 85492 | follower assembly | 18 | 120 |
| 84990 | vent valve assembly | 18 | 120 |
| 271606 | drum cover | 55 | 400 |
| 270982 | follower assembly | 55 | 400 |
| 271605 | vent valve assembly | 55 | 400 |
| 84980 | vent valve | 18, 55 | 120, 400 |
| 237-11204-8 | ultrasonic high/low sensor | 18, 55 | 120, 400 |



NOTE

Further technical information, technical drawings, accessories, spare parts or product function descriptions available on SKF.com/lubrication.

Pump unit

MPB



Description

The MPB pump unit is especially designed for automatic lubrication systems. The unique feature in it compared to traditional air-operated barrel pump with mechanical air motor valve is its magnetically operated air motor valve. This will reduce the amount of mechanical components in the air motor and also eliminates the need of lubrication in the air motor. The pump is suitable for use with 18, 50 and 180 kg (40, 120 and 400 lb) lubricant barrels. And when equipped with a suitable adapter MPB pump unit can also be used in lubricant bulk containers.

Features and benefits

- Lubrication-free, electronically controlled air motor enables accurate control of pump output
- Fewer mechanical components extend a service life of the air motor
- Includes self-diagnosing system
- Operates effectively in wide range of temperatures
- IP 65 protection rating
- Suitable for use with grease metering devices of category 5, 6 and 7 (→ page 123)

Applications

- Paper industry
- Steel industry
- Heavy industry



Technical data

| | |
|---|---|
| Function principle | air operated piston pump for barrels |
| Operating temperature | -10 to +55 °C, 14 to 131 °F |
| Operating pressure | max. 300 bar, 4 350 psi |
| Pressure ratio | 1:65 |
| Pressure air supply | 2 to 4,5 bar, 29 to 65 psi |
| Air consumption | max. 300 l/min; 80 gal/min |
| Lubricant | grease up to NLGI 2 oil up to 20–10 000 mm ² /s |
| Metering quantity per cycle ¹⁾ | 6,1 cm ³ ; 0,37 in ³ |
| Electrical connections | 20–32 V DC |
| Drum capacity | 18, 50 and 180 kg, 40, 120 or 400 lb drum not included |
| Protection class | IP 65 |
| Dimensions | depending on the model min. 650 × 130 × 130 mm max. 920 × 130 × 130 mm min. 25,6 × 5,11 × 5,11 in max. 36,22 × 5,11 × 5,11 in |
| Mounting position | vertical |

¹⁾ generally approx. 50 cycles/min are assumed



NOTE

Further technical information, technical drawings, accessories, spare parts or product function descriptions available on SKF.com/lubrication:

PUB LS/P8 17178 EN

Pump unit

MPB

Order information

| Order number | Designation | Suitable barrel size | |
|--------------|------------------|----------------------|-----|
| | | kg | lb |
| 12381702 | SKF-MPB-PUMP-1/8 | 18 | 40 |
| 12381701 | SKF-MPB-PUMP-1/4 | 50 | 120 |
| 12381700 | SKF-MPB-PUMP-1/1 | 180 | 400 |

Accessories

Air regulator unit



Air regulator unit

| Order number | Designation |
|--------------|----------------|
| 12382666 | MAX-V2-SET-MPB |

Lid sets



Lid sets

| Order number | Designation |
|---|--------------------------|
| ECO version - dynamic pump position on barrel (acc. to filling level) | |
| 12381381 | MAXV2-LIDSET-1/1-ECO-MPB |
| 12381382 | MAXV2-LIDSET-1/4-ECO-MPB |
| 12381383 | MAXV2-LIDSET-1/8-ECO-MPB |
| STA version - static pump position on barrel | |
| 12381384 | MAXV2-LIDSET-1/1-STA-MPB |
| 12381385 | MAXV2-LIDSET-1/4-STA-MPB |
| 12381386 | MAXV2-LIDSET-1/8-STA-MPB |

Pump unit

84050, 85460



Description

Models 84050 and 85460 are air-operated, double-acting pumps for high-volume displacement. Both pumps are supplied with a 27 kg (60 lb) capacity metal reservoir with removable cover for easy filling. It includes an air-operated vent valve and air and lubricant connecting hoses. Model 85460 features a visual low-level and follower plate assembly.

Features and benefits

- Rugged, 14-gauge steel walls
- Large 1 inch NPT inlet for fast filling, 1 1/4 in overflow outlet
- 2 inch foam follower that virtually eliminates grease bypass
- Vent valve to bucket coupling
- Thick mounting ring that withstands severe vibration
- Bulk filling method
- Remote system components such as 3/2-way valves, adjustments for air power, and monitoring of pump are available separately on request
- Suitable for use with grease metering devices of category 5, 6 and 7 (→ page 123)

Applications

- Pulp and paper industry
- Construction machinery
- Food and beverage
- Mining



Technical data

| | |
|-----------------------|---|
| Order number | 84050 85460 |
| Function principle | air operated, double-acting piston pump |
| Outlets | 1 |
| Metering quantity | 492 cm ³ /stroke, 30 in ³ /stroke |
| Lubricant | grease NLGI 0, 1, 2 |
| Operating temperature | -23 to +60 °C; -10 to +140 °F |
| Operating pressure | min. 82 bar, 1 200 psi max. 240 bar, 3 500 psi |
| Transmission ratio | 50:1 |
| Reservoir | 27,0 kg; 60.0 lb |
| Material (reservoir) | steel |
| Connection outlet | 3/4 NPTF (F) |
| Air inlet | 3/8 NPTF (F) |
| Dimensions | 806 × 392 × 395 mm 31.75 × 15.44 × 15.56 in |
| Mounting position | vertical |

Pump requires 3-way air valve
Air consumption at 6,9 bar, 100 psi, is 0,004 M³/min, 0.15 ft³/min, per stroke
Optional 92597 follower available



NOTE

Further technical information, technical drawings, accessories, spare parts or product function descriptions available on SKF.com/lubrication.

Pump unit

282288



Description

Model 282288 is an air-operated, positive-displacement pump delivering a maximum volume by means of a single stroke of the pump unit. A solenoid air valve is 58 integrated into the pump body. Designed to deliver grease to single-line metering devices, 282288 includes a special high-volume refill fitting, a 2 1/2 in pneumatically driven pump, a vent valve assembly and air and lubricant connecting hoses.

Features and benefits

- Modular structure consists of 2 1/2 in air motor, pump and vent assembly, air and lubricant connecting hoses
- For U. S. standard refinery drums (removable head)
- For clean and safe drum replacement
- Simplified, modular design
- Suitable for use with grease metering devices of category 5, 6 and 7 (→ page 123)

Applications

- Agriculture
- Chemical industry
- Steel industry

Technical data

| | |
|-----------------------|---|
| Order number | 282288 |
| Function principle | air operated, reciprocating piston pump |
| Outlets | 1 |
| Metering quantity | 492 cm ³ /stroke, 30 in ³ /stroke |
| Lubricant | grease NLGI 0, 1, 2 |
| Operating temperature | -15 to +121 °C; +5 to +250 °F |
| Operating pressure | min. 82 bar, 1 200 psi max. 240 bar, 3 500 psi |
| Transmission ratio | 50:1 |
| Reservoir | 55 kg; 120 lb |
| Drum size | standard 120 lb. refinery drum |
| Material | nitrile, steel, polyurethane |
| Connection outlet | 3/4 NPTF (F) |
| Air inlet | 3/8 NPTF (F) |
| Voltage (controller) | 120 V, 60 Hz; 110 V, 50 Hz |
| Dimensions | 381 × 381 × 975 mm 15 × 15 × 38.375 in |
| Mounting position | vertical |

Air consumption at 6,9 bar, 100 psi, is 0,004 M³/min, 0.15 ft³/min, per stroke
83371 follower plate is available as an optional accessory



NOTE

Further technical information, technical drawings, accessories, spare parts or product function descriptions available on SKF.com/lubrication.

Pump unit

P 603S



Description

The simple-to-install, all-in-one design of the P 603S pump includes the programmable controller, a pressure switch/transducer and a vent valve. It is quick and easy to change out a metering device as the main line or nearby metering devices do not have to be removed. The exchange can be performed between lubrication cycles so that there is no wasted lubricant or excessive costly downtime. An additional pressure switch/transducer at the end of larger systems can be used for added pressure control to ensure correct lubrication. For rotating operation in wind turbines, the reservoir is equipped with a follower plate and stirring paddle, which also facilitates the use of fast-separating lubricants. For stationary operations, a stirring and fixed paddle is sufficient.

Features and benefits

- Simple maintenance
- Easy system expansion
- Robust design with easy system layout
- Suitable for fast-separating lubricants
- SE2 suction elements for used lubricant
- C5 corrosion protection available on request
- QSL / SL/SLC metering devices suitable for high pressure
- Suitable for use with grease metering devices of category 5, 6 and 7 (→ page 123)

Applications

- Wind turbines, construction machinery
- Mining and mineral processing
- Commercial vehicles



Technical data

| | |
|-----------------------|--|
| Function principle | electrically operated piston pump |
| Outlets | 1 |
| Metering quantity | 12 cm ³ /min, 0.73 in ³ /min |
| Lubricant | grease up to NLGI 2 |
| Operating temperature | -40 to +70 °C, -40 to +158 °F |
| Operating pressure | max. 300 bar, 4 350 psi |
| Reservoir | 4, 8, 10, 15, 20, 30*, 40* or 100* kg 9, 18, 22, 33, 44, 66*, 88* or 220* lb |
| Pumping elements | 3 (Ø 7 mm, 0.27 in) |
| Operating voltage | 12, 24 VDC, 115/230 VAC |
| Current draw | max. 2 A |
| Connectors | 12, 24 VDC: bayonet style AC: bayonet style plus square type |
| Material | |
| Reservoir | thermoplastic |
| Housing | cast aluminum alloy, polycarbonate |
| Connection outlet | G1/4 |
| Approvals | UL/CSA, CE |
| Protection class | IP 6K 9K |
| Dimensions | min. 240 × 235 × 415 mm max. 500 × 400 × 1 064 mm min. 9.45 × 9.25 × 16.3 in max. 19.7 × 15.7 × 41.9 in |
| Mounting position: | |
| with stirring paddle | reservoir upside up |
| with follower plate | any |

* reservoir made of steel without follower plate



NOTE

Further technical information, technical drawings, accessories, spare parts or product function descriptions available on SKF.com/lubrication.

Pump unit

P 603S

Identification code **P603S** - - - .

Product design

Corrosion protection class
 _ = C3
X = C5-M-H protection time ≥ 15 years ²⁾
X = C5-M-K protection time ≤ 5 years ^{2), 3)}

Approval
 _ = CE
U = UL/CSA

Reservoir capacities ¹⁾
4 = plastic, 4 l; 1.05 gal **20** = plastic, transparent, 20 l; 5.28 gal
8 = plastic, 8 l; 2.11 gal **30** = metal, 30 l; 7.92 gal
10 = plastic, 10 l; 2.64 gal **40** = metal, 40 l; 10.56 gal
15 = plastic, 15 l; 3.96 gal **100** = metal, 100 l; 26.4 gal

Reservoir type
XL = grease reservoir with low-level indication ²⁾ (for metal reservoirs only)
XNBO = grease reservoir without low-level indication and refilling from top (for plastic reservoirs only)
XLBO = grease reservoir, with low-level indication and refilling from top (for plastic reservoirs only)
XLF = plastic, grease reservoir with empty message and follower plate ¹⁾ (for plastic reservoirs only)

Pump elements
1Z7 = 4,0 cm³/min; 0.24 in³/min (single pump element)
2Z7 = 8,0 cm³/min; 0.48 in³/min (2 pump elements combined in one outlet)
3Z7 = 12,0 cm³/min; 0.73 in³/min (3 pump elements combined in one outlet)

Power supply
12 = 12 V DC **24** = 24 V DC **AC** = 100-240 V AC, 50/60 Hz, with 24 V DC direct current motor

Electric connections
1A = AC: square-type plug for power supply, grounding equipment conductor
1A = DC: bayonet plug, 7/4-pole for power supply, low-level control, protective conductor
2A = AC: square-type plug for power supply, bayonet plug, 4-pole for low-level control or relay

Type of connection
1 = square plug **7** = bayonet plug 7/7-pole

Connections from the pump to external devices
00 = without connection socket and without cable **16** = bayonet socket with cable (10 m; 33 ft) 7/7-core
01 = with connecting socket, without cable **20** = bayonet socket with cable (20 m; 66 ft) 7/7-core

Control boards
S01-S24 = standard control board **SR-BR** = standard control board with relay

Pressure sensors
SE = Pressure sensor adjustable via membrane keyboard **DS** = Pressure switch

¹⁾ Electrical signal should be taken from top of lid, 30, 40 and 100 l (7.92; 10.5 and 26.4 gal) reservoirs without follower plate
²⁾ The corrosion protection period is not a warranty period
³⁾ Only valid for steel reservoirs

| Pump element | | | |
|--------------------|---|-------------------------|-------------------------|
| Order number | Description | Metering quantity | |
| | | cm ³ /stroke | in ³ /stroke |
| 645-77196-1 | outlet combinable pump element Z7, corrosion class C3 incl. sealing ring | 0,246 | 0.015 |
| 645-77625-1 | outlet combinable pump element Z7, corrosion class C5M incl. sealing ring | 0,246 | 0.015 |

| Pressure relief valve | | | | | |
|-----------------------|--------------------|------------------|-------|------------|------|
| Order number | Designation | Opening pressure | | Connection | Ø mm |
| | | bar | psi | | |
| 624-29056-1 | SVET-350-G 1/4A-D6 | 350 | 5 075 | 6 | |
| 624-29054-1 | SVET-350-G 1/4A-D8 | 350 | 5 075 | 8 | |

Pump unit

Minilube



Description

Minilube is a handy solution for vehicles with few lubrication points, such as mini-excavators, mini wheel loaders, buses and delivery trucks. Installing Minilube is easy and quick, because everything is already integrated: control centre, pressure switch and alarm lights. Additional alarm lights can be installed, for example, in the vehicle's cabin. Pumped grease is distributed accurately through pre-engineered metering device groups.

Features and benefits

- Compact lubrication system for few lubrication points
- Improves worker safety as system lubricates all connected lubrication points regardless of machinery location
- Minimizes lubricant waste to environment by maintaining optimal lubrication level
- Easy and quick installation and commissioning
- Suitable for use with grease metering devices of category 4 and 5 (→ page 123)

Applications

- Small excavators
- Wheel loaders
- Buses
- Delivery trucks
- Vehicles

Technical data

| | |
|-----------------------|--|
| Function principle | electrically operated piston pump |
| Outlets | 1 |
| Metering quantity | |
| 12 VDC | 6,5 cm ³ /min, 0,4 in ³ /min |
| 24 VDC | 13 cm ³ /min, 0,8 in ³ /min |
| Lubricant | grease up to NLGI 1 |
| Operating temperature | -30 to +70 °C, -22 to +158 °F |
| Operating pressure | max. 250 bar, 3 625 psi |
| Reservoir | 2 kg, 4 lb |
| Material | acrylic, steel, aluminum, polyurethane, nitrile |
| Connection outlet | R 1/4 in |
| Operating voltage | 12/24 VDC |
| Power consumption | 150 W, 0,2 HP |
| Protection class | IP 65 |
| Dimensions | 327 × 273 × 184 mm 12,9 × 10,75 × 7,25 in |
| Mounting position | vertical |



NOTE

Further technical information, technical drawings, accessories, spare parts or product function descriptions available on SKF.com/lubrication:

12236 EN

Pump unit

Minilube

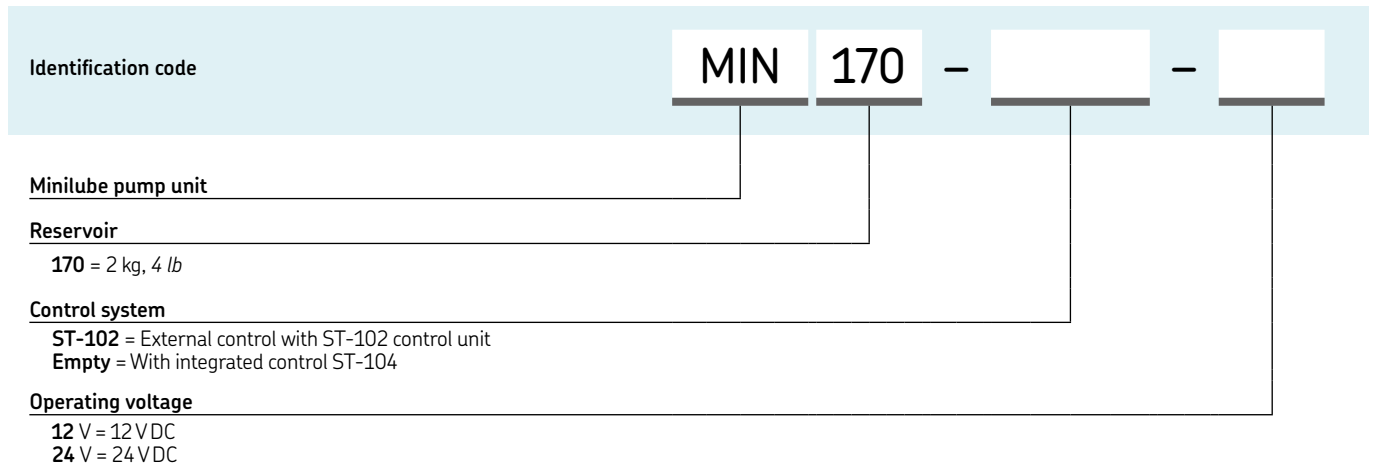

Pump unit

KFG



Description

The KFG pump unit is an electrically driven piston pump. The pump is comprised of four main components: housing with pump elements; reservoir with fill-level monitoring; internal control units; and attachments. The housing integrates the motor, the drive shaft with an eccentric and up to three pump elements for delivering the lubricant. Positively driven pump elements should be used in order to maintain the delivery rate in areas with extremely low temperatures or in applications where an increased influence of dirt is unavoidable.

Features and benefits

- Reliable: due to durable materials, robust components and designs for extreme conditions (with positively driven pump elements)
- Plug-and-play pump design for reduced installation time
- Application-oriented: individual designs through user-friendly product customizer
- Versatile: can be used as a single-line (SKF MonoFlex) and as a progressive pump (SKF ProFlex)
- Safe: through fill-level monitoring, lubrication system monitoring, pressure relief and control unit
- Options: Top filling, several electronic options
- Suitable for use with grease metering devices of category 5, 6 and 7 (→ page 123)

Applications

- Wind turbines
- Construction machinery
- Vehicle aftermarket
- Rotary applications
- Industry



Technical data

| | |
|---|---|
| Function principle | electrically operated piston pump |
| Outlets | 1–3 |
| Metering quantity | 5.0 to 15 cm ³ /min 0.3 to 0.9 in ³ /min |
| Lubricant | NLGI 000 to 2 with EP additives, compatible with plastics, NBR elastomers, copper and copper alloys |
| Operating temperature with spring-return pump element | –25 to +70 °C, –13 to +158 °F |
| with posit. driven pump element | –30 to +70 °C, –22 to +158 °F |
| Operating pressure | max. 300 bar; 4 351psi |
| Flow pressure | 0.45 to 0.7 bar, 6.5 to 10.2 psi |
| Reservoir | 2; 4; 6; 8; 10; 12; 15; 20 kg 4, 9, 13, 18, 22, 26, 33, 44 lb |
| Material (reservoir) | polyamide PA 6I, PMMA |
| Material (pump housing) | aluminum-silicon cast alloy |
| Connection outlet | M14×1.5 mm |
| Operating voltage | 12 VDC, 24 VDC, 230 VAC (100–273 VAC) |
| Dimensions | min 229 × 268 × 208mm max 1 170 × 268 × 216 mm min 9.01 × 10.55 × 8.2 in max 46 × 10.55 × 8.5 in |
| Mounting position | vertical (with follower plate; any) |

NOTE

Further technical information, technical drawings, accessories, spare parts or product function descriptions available on SKF.com/lubrication:

1-3030 -EN, 951-170-211



3D

skf-lubrication.partcommunity.com/3d-cad-models

Pump unit

Multilube MLPV/MLPI



Description

Multilube pump units (MLPV for heavy vehicles, MLPI for industrial applications) help to ensure that the lubrication result is optimal, while reducing energy and lubricant consumption. All relevant components (control unit, pump, reservoir, directional valve and pressure monitoring) are integrated into its modular pumping unit. Built-in heating allows it to be operated even under demanding and cold circumstances.

Features and benefits

- Compact, all-in-one structure
- Modular and durable design
- Easy to install and start-up
- Two reservoir sizes
- Pumping element equipped with pressure-relief valve
- Filling connection equipped with filling filter
- Visual and electric low-level monitoring in reservoir
- Pumping center is equipped with heating device
- Clear and versatile user interface
- Wide operating temperature range
- Suitable for use with grease metering devices of category 5, 6 and 7 (→ page 123)

Applications

- Stand-alone machines
- Construction machinery
- Mining applications

Technical data

| | |
|-----------------------|---|
| Function principle | electrically operated piston pump |
| Outlets | 1 (for single-line applications) |
| Metering quantity | 16 cm ³ /min; 0.976 in ³ /min |
| Lubricant | oil, fluid grease and grease up to NLGI 2 |
| Operating temperature | -30 to +60 °C, -22 to +140 °F |
| Operating pressure | max. 200 bar, 2 900 psi |
| Reservoir | 4 or 10 kg, 9 or 22 lb |
| Material | aluminum, polyurethane, nitrile |
| Connection outlet | G 1/4 |
| Operating voltage | 12/24 VDC, 115 VAC, 230 VAC |
| Power consumption | 150 W, 0.2 HP |
| Protection class | IP 67 (IP 65 with user-interface IF-103) |
| Dimensions: | |
| with 4 kg reservoir | 539 × 274 × 250 mm |
| with 9 lb reservoir | 21.22 × 10.78 × 9.84 in |
| with 10 kg reservoir | 720 × 274 × 250 mm |
| with 22 lb reservoir | 27.09 × 10.78 × 9.84 in |
| Mounting position | vertical and horizontal |



NOTE

Further technical information, technical drawings, accessories, spare parts or product function descriptions available on SKF.com/lubrication:

6407/2 EN

Pump unit

Multilube MLPV/MLPI

MLPV (vehicle applications)

| Order number ¹⁾ | Designation | Reservoir capacity | | Operating voltage | | Control unit |
|----------------------------|------------------------|--------------------|----|-------------------|--------|--------------|
| | | kg | lb | 12 VDC | 24 VDC | |
| 11395200 | MLPV-4-1-12 | 4 | 9 | • | – | – |
| 11395210 | MLPV-4-1-24 | 4 | 9 | – | • | – |
| 11395211 | MLPV-10-1-24 | 10 | 22 | – | • | – |
| 11395254 | MLPV-4-1-24-IF103-PSE | 4 | 9 | – | • | IF103 |
| 11395227 | MLPV-10-1-12-IF103-PSE | 10 | 22 | • | – | IF103 |

¹⁾ Further MLPV versions available on request.

MLPI (industrial applications)

| Order number ¹⁾ | Designation | Reservoir capacity | | Operating voltage | | | Control unit | Build in pressure sensor |
|----------------------------|-------------------------|--------------------|----|-------------------|---------|---------|--------------|--------------------------|
| | | kg | lb | 24 VDC | 115 VAC | 230 VAC | | |
| 12389919 | MLPI-4-1-24-IF103-PSE | 4 | 9 | • | – | – | IF103 | • |
| 12389942 | MLPI-4-1-24-24-PSE | 4 | 9 | • | – | – | – | • |
| 12389937 | MLPI-4-1-115-IF103-PSE | 4 | 9 | – | • | – | IF103 | • |
| 12389944 | MLPI-4-1-115-IF103-EPT | 4 | 9 | – | • | – | IF103 | – |
| 12389912 | MLPI-4-1-230-IF103-PSE | 4 | 9 | – | – | • | IF103 | • |
| 12389925 | MLPI-4-1-230-IF103-EPT | 4 | 9 | – | – | • | IF103 | – |
| 12389936 | MLPI-10-1-115-IF103-PSE | 10 | 22 | – | • | – | IF103 | • |
| 12389943 | MLPI-10-1-115-IF103-EPT | 10 | 22 | – | • | – | IF103 | – |
| 12389916 | MLPI-10-1-230-IF103-PSE | 10 | 22 | – | – | • | IF103 | • |
| 12389924 | MLPI-10-1-230-IF103-EPT | 10 | 22 | – | – | • | IF103 | – |
| 12389954 | MLPI-10-1-230-24-EPT | 10 | 22 | – | – | • | – | – |

¹⁾ Further MLPI versions available on request.

Accessories

Control unit



Control unit

| Order number | Designation | Description |
|-----------------|-------------|--|
| 11500610 | ST-102 | ST-102 control center to be located in machinery cabin |
| 12380747 | e-SMS-C | SMS control and monitoring module |

Pump unit

P 653S



Description

The fully integrated P 653S pump unit* is an example of the Lincoln brand's commitment to providing innovative, cost-effective solutions through industry-leading advances in technology. This next-generation, lower-cost pump package can be fitted with one of seven reservoir sizes and easily adapts to many applications. It also interfaces with telematics technology in today's heavy equipment. A neutral switch allows mobile equipment to remain idling with pump power on, but the timer is deactivated, allowing manual lubrication functionality. All pumps include low-level and system fault alarms. Simply mount the pump, connect the power and supply lines, and the system is ready for operation.

Features and benefits

- Integration of major system components reduces operation costs
- Plug-and-play pump design for reduced installation time
- Neutral switch ensures reduces grease consumption
- C5 corrosion protection available on request
- Suitable for use with grease metering devices of category 5, 6 and 7 (→ page 123)

Applications

- Construction machinery
- Mining and mineral processing
- Commercial vehicles
- Renewable energy

* All models are designed for grease and have stirring paddle and low level detection. Pumps include remote signal cable, relief valve, electrical connections and external pressure switch/transducer (as specified for each model).

Technical data

| | |
|-----------------------|---|
| Function principle | electrically operated piston pump |
| Outlets | 1 |
| Metering quantity | 24,6 cm ³ /min, 1.5 in ³ /min |
| Lubricant | grease up to NLGI 2 |
| Operating temperature | VDC: -40 to +70 °C, -40 to +158 °F VAC: 0 to +50 °C, +32 to +122 °F |
| Operating pressure | pressure switch, fixed: 240 bar, 3 500 psi; pressure transducer, adjustable: 96 to 317 bar, 1 400 to 4 600 psi end of line pressure switch and transducer setting, not adjustable: 172 bar, 2 500 psi |
| Reservoir | 4, 8, 10, 15, 20, 30*, 40* or 100* kg 9, 18, 22, 33, 44, 66*, 88* or 220* lb |
| Material: | |
| Reservoir | thermoplastic |
| Housing | cast aluminum alloy, polycarbonate |
| Connection outlet | G 1/4 |
| Pause time | max. 59 h, 59 min min. 4 min |
| Pause time increments | 1 hr or 1 min |
| Pumping time | max. 12 min |
| Approvals | UL/CSA, CE |
| Protection class | IP 6K 9K |
| Dimensions | min. 240 × 235 × 415 mm max. 500 × 400 × 1 064 mm min. 9.45 × 9.25 × 16.3 in max. 19.7 × 15.7 × 41.9 in |
| Mounting position: | |
| with stirring paddle | reservoir upside up |
| with follower plate | any |

* Reservoir sizes 30, 40 and 100 kg made of steel without follower plate are available on request.

Pump unit

P 653S

Order information

| Order number | Operating voltage | | Reservoir capacity | | Follower plate | Internal pressure switch | Internal pressure transducer | Internal and end-of-line pressure switch | Internal and end-of-line pressure transducer | Display and pressure setting in |
|-------------------------------------|-------------------|-------------|--------------------|----|----------------|--------------------------|------------------------------|--|--|---------------------------------|
| | 24 VDC | 120/230 VAC | kg | lb | | | | | | |
| Display and pressure setting in psi | | | | | | | | | | |
| 80086 | • | – | 4 | 9 | – | • | – | – | – | psi |
| 80087 | • | – | 4 | 9 | – | – | • | – | – | psi |
| 80105 | • | – | 4 | 9 | – | – | – | • | – | psi |
| 80106 | • | – | 4 | 9 | – | – | – | – | • | psi |
| 80077 | • | – | 4 | 9 | • | – | • | – | – | psi |
| 80109 | • | – | 4 | 9 | • | – | – | • | – | psi |
| 80090 | • | – | 8 | 18 | – | • | – | – | – | psi |
| 80091 | • | – | 8 | 18 | – | – | • | – | – | psi |
| 80107 | • | – | 8 | 18 | – | – | – | • | – | psi |
| 80108 | • | – | 8 | 18 | – | – | – | – | • | psi |
| 80080 | • | – | 8 | 18 | • | • | – | – | – | psi |
| 80081 | • | – | 8 | 18 | • | – | • | – | – | psi |
| 80111 | • | – | 8 | 18 | • | – | – | • | – | psi |
| 80112 | • | – | 8 | 18 | • | – | – | – | • | psi |
| 80121 | • | – | 15 | 33 | • | – | • | – | – | psi |
| 80122 | • | – | 15 | 33 | – | – | • | – | – | psi |
| 80120 | • | – | 20 | 44 | – | – | • | – | – | psi |
| 80082 | – | • | 4 | 9 | – | • | – | – | – | psi |
| 80083 | – | • | 4 | 9 | – | – | • | – | – | psi |
| 80084 | – | • | 4 | 9 | – | – | – | • | – | psi |
| 80085 | – | • | 4 | 9 | – | – | – | – | • | psi |
| 80072 | – | • | 4 | 9 | • | • | – | – | – | psi |
| 80073 | – | • | 4 | 9 | • | – | • | – | – | psi |
| 80074 | – | • | 4 | 9 | • | – | – | • | – | psi |
| 80075 | – | • | 4 | 9 | • | – | – | – | • | psi |
| 80088 | – | • | 8 | 18 | – | • | – | – | – | psi |
| 80089 | – | • | 8 | 18 | – | – | • | – | – | psi |
| 80078 | – | • | 8 | 18 | • | • | – | – | – | psi |
| 80079 | – | • | 8 | 18 | • | – | • | – | – | psi |
| 80134 | – | • | 15 | 33 | – | – | • | – | – | psi |
| 80135 | – | • | 20 | 44 | • | – | – | – | • | psi |
| Display and pressure setting in bar | | | | | | | | | | |
| 645-41176-1 | • | – | 8 | 18 | – | – | • | – | – | bar |
| 645-41176-2 | • | – | 8 | 18 | – | • | – | – | – | bar |
| 645-41177-1 | • | – | 15 | 33 | – | – | • | – | – | bar |
| 645-41325-4 | – | • | 8 | 18 | – | – | • | – | – | bar |
| 645-41176-3 | – | • | 8 | 18 | – | • | – | – | – | bar |
| 645-41177-3 | – | • | 15 | 33 | – | – | • | – | – | bar |

Note: All models are designed for grease and include stirring paddle and low-level detection. Pumps include remote signaling cable, relief valve, electrical connectors and external pressure switch or transducer (as indicated for each model).

Pump element

| Order number | Description | Metering quantity | |
|--------------|---|-------------------------|-------------------------|
| | | cm ³ /stroke | in ³ /stroke |
| 645-77196-1 | outlet combinable pump element Z7, corrosion class C3 incl. sealing ring | 0,246 | 0.015 |
| 645-77625-1 | outlet combinable pump element Z7, corrosion class C5M incl. sealing ring | 0,246 | 0.015 |

Pressure relief valve

| Order number | Designation | Opening pressure | | Connection |
|--------------|--------------------|------------------|-------|------------|
| | | bar | psi | |
| 624-29056-1 | SVET-350-G 1/4A-D6 | 350 | 5 075 | 6 mm |
| 624-29054-1 | SVET-350-G 1/4A-D8 | 350 | 5 075 | 8 mm |
| 624-77150-1 | SVTS-400-R1/4 | 400 | 5 800 | R 1/4 |

Pump unit

E-PUMP



Description

The electrical barrel pumping unit E-PUMP is a versatile barrel pump and it is especially designed for pumping oil or grease lubricants up to NLGI grade 2 into a centralized lubrication system. When equipped with a change-over valve unit, as E-VALV e.g. or a shut-off valve as E-VALVE-S e.g. it can be used either in single-line, dual-line or progressive lubrication systems. A complete pumping center consists of a pumping unit and a lid set. EPUMP-XXX-ECO coding is referring to ECO lid sets (descending pump head with follower plate), which are suitable for greases in NLGI grades 1 and 2 while EPUMP-XXX-STA coding is referring to STA lid sets (pump head always at barrel bottom), which are suitable for oil or greases in NLGI 0, 00 and 000 classes.

Features and benefits

- EPUMP models reflecting typical and often used barrel sizes
- Compact electrically operated pump for applications where no air supply is available
- An internal pressure control and a heating element secure the pump's function in high-pressure conditions and cold climates
- Suitable for use with grease metering devices of category 5, 6 and 7 (→ page 123)

Applications

- Heavy industries (paper, steel and other process industries)
- Mining and mineral processing
- Machinery workshops
- Food and beverage
- Cement industry



Technical data

| | |
|-------------------------|--|
| Function principle | electrically operated pump |
| Outlets | 1 |
| Number of pump elements | 4 |
| Metering quantity | 55 g/min; 0.3880136 oz/min |
| Operating temperature | -30 to +70 °C, -20 to 160 °F |
| Operating pressure | max. 240 bar, 3 480 psi |
| Lubricant | grease up to NLGI 2 oil up to 40–1 000 mm ² /s |
| Operating voltage | 20–32 V DC |
| Power consumption | 150 W |
| Heater | 40W/24V, heater resistor for pump elements in ECO models LED's 5 yellow, 1 green, 1 red |
| Display | 18, 50 and 180 kg, 40, 120 or 400 lb |
| Drum capacity | drum not included |
| Pressure sensor | 50–240 bar adjustable in 25 bar steps 725.1 to 3480.9 psi in 362.6 psi steps |
| Protection class | IP 65 |
| Dimensions | depending on the model min. 400 × 400 × 800 mm max. 400 × 400 × 1 300 mm min. 15.75 × 15.75 × 31.49 in max. 15.75 × 15.75 × 51.18 in |
| Mounting position | vertical |



NOTE

Further technical information, technical drawings, accessories, spare parts or product function descriptions available on SKF.com/lubrication

Pump unit

E-PUMP

Order information

| Order number | Designation | Lubricant | Control | Suitable barrel size | |
|-----------------|-------------------------|------------------------------------|---|----------------------|-----|
| | | | | kg | lb |
| 12375000 | SKF-EPUMP-1/8-ECO-24-1 | Grease up to NLGI 2 | integrated control unit for single-line systems | 18 | 40 |
| 12375080 | SKF-EPUMP-1/4-ECO-24-1 | Grease up to NLGI 2 | integrated control unit for single-line systems | 50 | 120 |
| 12375160 | SKF-EPUMP-1/1-ECO-24-1 | Grease up to NLGI 2 | integrated control unit for single-line systems | 180 | 400 |
| 12375200 | SKF-EPUMP-1/8-STA-24-1 | Oil up to 1 000 mm ² /s | integrated control unit for single-line systems | 18 | 40 |
| 12375120 | SKF-EPUMP-1/4-STA-24-1 | Oil up to 1 000 mm ² /s | integrated control unit for single-line systems | 50 | 120 |
| 12375040 | SKF-EPUMP-1/1-STA-24-1 | Oil up to 1 000 mm ² /s | integrated control unit for single-line systems | 180 | 400 |
| 12375180 | SKF-EPUMP-1/8-ECO-24-CC | Grease up to NLGI 2 | external control unit | 18 | 4.5 |
| 12375100 | SKF-EPUMP-1/4-ECO-24-CC | Grease up to NLGI 2 | external control unit | 50 | 13 |
| 12375020 | SKF-EPUMP-1/1-ECO-24-CC | Grease up to NLGI 2 | external control unit | 180 | 45 |
| 12375220 | SKF-EPUMP-1/8-STA-24-CC | Oil up to 1 000 mm ² /s | external control unit | 18 | 4.5 |
| 12375140 | SKF-EPUMP-1/4-STA-24-CC | Oil up to 1 000 mm ² /s | external control unit | 50 | 13 |
| 12375060 | SKF-EPUMP-1/1-STA-24-CC | Oil up to 1 000 mm ² /s | external control unit | 180 | 45 |

Accessories

Lid sets for grease barrels



Lid sets for grease barrels

| Order number | Designation | Lubricant | for barrel size | |
|-----------------|------------------|-----------|-----------------|-----|
| | | | kg | lb |
| 12381280 | E-LIDSET-1/8-ECO | Grease | 18 | 40 |
| 12381285 | E-LIDSET-1/4-ECO | Grease | 50 | 120 |
| 12381290 | E-LIDSET-1/1-ECO | Grease | 180 | 400 |

Lid sets for oil

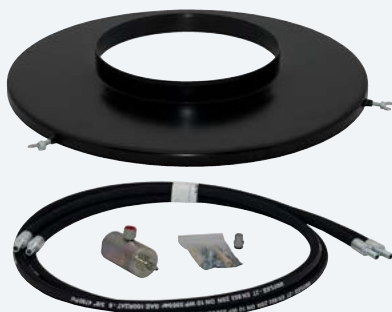

Lid sets for oil barrels

| Order number | Designation | Lubricant | for barrel size | |
|-----------------|------------------|-----------|-----------------|-----|
| | | | kg | lb |
| 12381292 | E-LIDSET-1/8-STA | Oil | 18 | 40 |
| 12381294 | E-LIDSET-1/4-STA | Oil | 50 | 120 |
| 12381296 | E-LIDSET-1/1-STA | Oil | 180 | 400 |

Pump unit

FK



Description

The FK pump unit is a multi-function piston pump with a versatile, modular structure. The FK pump unit can be used as a single-line, dual-line or progressive pump unit with or without integrated reversing valves. The modular structure of the pump also allows it to be retrofitted from one of the above-mentioned lubrication systems to another system without much effort or expense. The pump, which was designed to handle demanding usage, is available with reservoir sizes of 15 kg (33 lb), 30 kg (66 lb) and 60 kg (132 lb).

Features and benefits

- Versatile, modular system; easy to retrofit to other systems
- High functional reliability due to positively driven pistons
- Fill-level monitoring (using ultrasonic sensor) with two adjustable switching points
- Suitable for use with grease metering devices of category 5, 6 and 7 (→ page 123)

Applications

- Automotive industry
- Rotary applications
- Assembly lines
- Printing presses



NOTE

Further technical information, technical drawings, accessories, spare parts or product function descriptions available on SKF.com/lubrication:
1-3033-EN, 951-170-200-EN



Technical data

| | |
|-----------------------|--|
| Function principle | electrically operated piston pump |
| Outlets | 1 |
| Metering quantity | 12,3 to 74 cm ³ /min 0.75 to 4.5 in ³ /min |
| Lubricant | mineral oils or environmentally compatible oils from ISO VG 46 to greases of NLGI Class 2 (consultation required for synthetic oils) |
| Operating temperature | -25 to +60 °C, -13 to +140 °F |
| Operating pressure | max. 400 bar, 5 800 psi |
| Reservoir | 15; 30 or 60 kg 33, 66 or 132 lb |
| Material | steel-sheet housing, steel, aluminum |
| Operating voltage | 230/400 VAC |
| Pumping elements | 1 to 6 |
| Filling method | via filler socket G 1/2 |
| Gear type | screw drive, type 1M |
| Gear ratio | 40:1 |
| Nominal speed | 1 500 rpm |
| Frequency | 50 Hz |
| Nominal output | 0,37 kW |
| Rated current | 1,09 A |
| Protection | IP 55-F |
| Connection outlet | G 1/2 |
| Dimensions: | |
| 15 kg, 33 lb | max. 470 × 598 × 335 mm max. 18.5 × 23.54 × 13.18 in |
| 30 kg, 66 lb | max. 665 × 598 × 335 mm max. 26.2 × 23.54 × 13.18 in |
| 60 kg, 132 lb | max. 1 035 × 598 × 335 mm max. 40.74 × 23.54 × 13.18 in |
| Mounting position | vertical |

Pump unit

FK

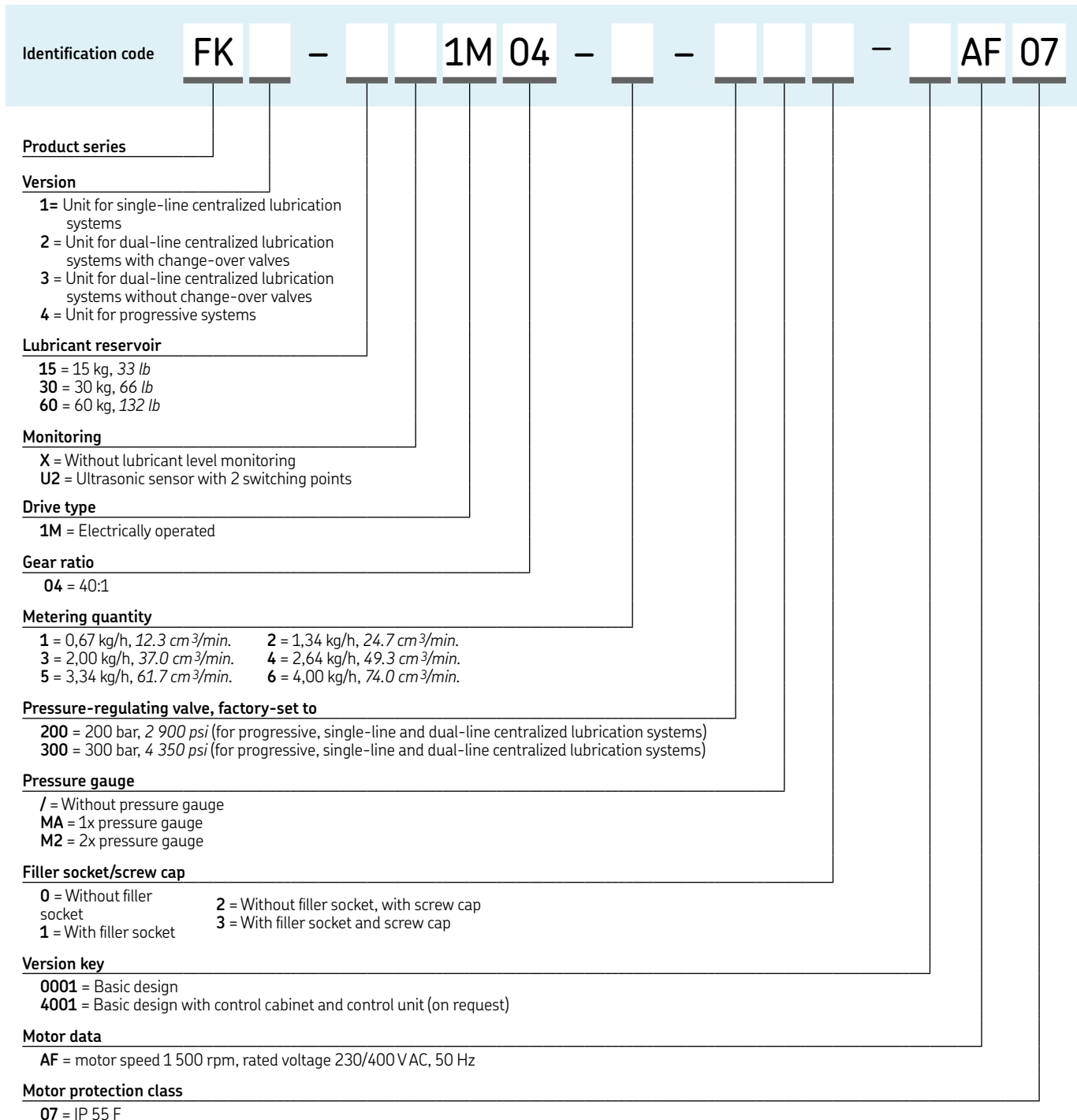

Pump unit

FlowMaster, electric



Description

Compact and versatile, its unique rotary drive and modular gear set let you adjust the speed of the pump's motor to exactly fit your application. FlowMaster pumps can save the cost of air and plug in 12/24 VDC, 120/230-1ph and 230/460-3ph VAC models.

The motion of pump created by the electric rotary motor is converted into reciprocating pump motion, providing an efficient lubricant flow. Because of its rotary drive, the motor can be placed directly on the pump. As a result, the pump is so compact it fits almost anywhere. FlowMaster pumps are optionally available incl. mechanical overflow prevention system to improve worker and environmental safety by helping to prevent hazards associated with reservoir overfilling.

Features and benefits

- Advanced technology: brushless DC motor
- Optional overflow prevention system to improve worker safety and minimize environmental concerns caused by overfilling
- Temperature and overload protection: durable and long-lasting product that reduces machinery downtime for maintenance; less repair costs
- Totally sealed: withstands washdowns
- Suitable for use with grease metering devices of category 5, 6 and 7 (→ page 123)

Applications

- Mining and mineral processing
- Construction machinery
- Food and beverage
- Paper mills
- Steel mills

Technical data

| | |
|-----------------------|--|
| Function principle | electrically operated piston pump |
| Outlets | 1 |
| Metering quantity | max. 103 cm ³ /min max. 6.3 in ³ /min |
| Lubricant | grease NLGI Grade 0, 1, 2 |
| Operating temperature | -40 to +65 °C; -40 to +150 °F |
| Operating pressure: | |
| 12 VDC | max. 251 bar; 3 500 psi |
| 24 VDC | max. 345 bar; 5 000 psi |
| 120 to 460 VAC | max. 345 bar; 5 000 psi |
| Operating voltage | 12/24 VDC; 120 to 460 VAC |
| Reservoir | 40, 55, 180 kg; 90, 120, 400 lb |
| Material | fluoroelastomer, polyurethane, steel, aluminum zinc casting |
| Connection outlet | 1/4 NPTF |
| Gear ratio | 17.8:1; 19:1; 34:1 |
| Nominal power | 5 to 50 and 9,5 to 100 rpm |
| Electric current: | |
| 12/24 VDC | 1 to 7.5 A |
| 120 VAC | 1 to 4.6 A |
| 230-460 VAC | 0,5 to 2,4 A |
| Dimensions: | |
| 16, 25, 28, 35, 40 kg | 360 × 350 × 170 mm |
| 35, 55, 60, 78, 90 lb | 14.17 × 13.78 × 6.7 in |
| 55 kg | 408 × 223 × 946 mm |
| 120 lb | 16.07 × 8.78 × 37.24 in |
| 180 kg | 408 × 223 × 1 111 mm |
| 400 lb | 16.07 × 8.78 × 43.24 in |
| Mounting position | vertical |



NOTE

Further technical information, technical drawings, accessories, spare parts or product function descriptions available on SKF.com/lubrication

Pump unit

FlowMaster, electric

Order information

| Order number | Description | Power | Reservoir capacity | | Ratio | Metering quantity | | | | Operating pressure max. | | Speed rpm |
|--------------|---|-----------------------------|--------------------|--------|--------|----------------------|----------------------|----------------------|----------------------|-------------------------|-------|-----------|
| | | | kg | lb | | min. | max. | min. | max. | bar | psi | |
| | | | | | | cm ³ /min | in ³ /min | cm ³ /min | in ³ /min | | | |
| 85479 | pump, follower, bucket cover, hardware | 24 VDC | 16 | 35 | 19:01 | 11,5 | 0.7 | 103 | 6.3 | 170 | 2 500 | 9,5–100 |
| 85728 | pump and reservoir | 24 VDC | 28 | 60 | 19:1 | 11,5 | 0.7 | 103 | 6.3 | 345 | 5 000 | 9,5–100 |
| 85729 | pump and reservoir | 24 VDC | 41 | 90 | 19:1 | 11,5 | 0.7 | 103 | 6.3 | 345 | 5 000 | 9,5–100 |
| 85730 | pump and reservoir | 24 VDC | 55 | 120 | 19:1 | 11,5 | 0.7 | 103 | 6.3 | 345 | 5 000 | 9,5–100 |
| 85728MSO | pump, reservoir, mechanical filling level sensor, mso ¹⁾ | 24 VDC | 28 | 60 | 19:1 | 11,5 | 0.7 | 103 | 6.3 | 345 | 5 000 | 9,5–100 |
| 85729MSO | pump, reservoir, mechanical filling level sensor, mso ¹⁾ | 24 VDC | 41 | 90 | 19:1 | 11,5 | 0.7 | 103 | 6.3 | 345 | 5 000 | 9,5–100 |
| 85730MSO | pump, reservoir, mechanical filling level sensor, mso ¹⁾ | 24 VDC | 55 | 120 | 19:1 | 11,5 | 0.7 | 103 | 6.3 | 345 | 5 000 | 9,5–100 |
| 85763MSO | pump, reservoir, magnetical fill level sensor, mso ¹⁾ | 24 VDC | 28 | 60 | 19:1 | 11,5 | 0.7 | 103 | 6.3 | 345 | 5 000 | 9,5–100 |
| 85762MSO | pump, reservoir, magnetical fill level sensor, mso ¹⁾ | 24 VDC | 41 | 90 | 19:1 | 11,5 | 0.7 | 103 | 6.3 | 345 | 5 000 | 9,5–100 |
| 85878MSO | pump, reservoir, magnetical fill level sensor, mso ¹⁾ | 24 VDC | 55 | 120 | 19:1 | 11,5 | 0.7 | 103 | 6.3 | 345 | 5 000 | 9,5–100 |
| 85736 | pump | 24 VDC | 16 | 35 | 19:1 | 11,5 | 0.7 | 103 | 6.3 | 345 | 5 000 | 9,5–100 |
| 85737 | pump | 24 VDC | 28 | 60 | 19:1 | 11,5 | 0.7 | 103 | 6.3 | 345 | 5 000 | 9,5–100 |
| 85738 | pump | 24 VDC | 55/40 | 120/90 | 19:1 | 11,5 | 0.7 | 103 | 6.3 | 345 | 5 000 | 9,5–100 |
| 85739 | pump | 24 VDC | 180 | 400 | 19:1 | 11,5 | 0.7 | 103 | 6.3 | 345 | 5 000 | 9,5–100 |
| 85740 | pump | 24 VDC | 25 | 55 | 19:1 | 11,5 | 0.7 | 103 | 6.3 | 345 | 5 000 | 9,5–100 |
| 85743 | pump | 115 to 230 VAC | 55/40 | 120/90 | 19:1 | 11,5 | 0.7 | 103 | 6.3 | 345 | 5 000 | 95 |
| 85744 | pump | 115 to 230 VAC | 180 | 400 | 19:1 | 11,5 | 0.7 | 103 | 6.3 | 345 | 5 000 | 95 |
| 85745 | pump | 220 to 420 VAC, 50 Hz, 3 ph | 55/40 | 120/90 | 19:1 | 11,5 | 0.7 | 103 | 6.3 | 345 | 5 000 | 9,5–100 |
| 85746 | pump | 220 to 420 VAC, 50 Hz, 3 ph | 180 | 400 | 19:1 | 11,5 | 0.7 | 103 | 6.3 | 345 | 5 000 | 9,5–100 |
| 85747 | pump | 24 VDC | 16 | 35 | 17.8:1 | 11,5 | 0.7 | 103 | 6.3 | 170 | 5 000 | 9,5–100 |
| 85748 | pump | 24 VDC | 16 | 35 | 34:1 | 6,55 | 0.4 | 57,4 | 3.5 | 345 | 5 000 | 5–50 |
| 85749 | pump | 24 VDC | 55/40 | 120/90 | 34:1 | 6,55 | 0.4 | 57,4 | 3.5 | 345 | 5 000 | 5–50 |
| 85750 | pump | 24 VDC | 16 | 35 | 7:1 | 11,5 | 0.7 | 103 | 6.3 | 345 | 5 000 | 9,5–100 |
| 85751 | pump | 24 VDC | 16 | 35 | 7:1 | 11,5 | 0.7 | 103 | 6.3 | 345 | 5 000 | 9,5–100 |
| 85752 | pump | 12 VDC | 16 | 35 | 19:1 | 11,5 | 0.7 | 103 | 6.3 | 170 | 2 500 | 9,5–100 |
| 85753 | pump | 12 VDC | 16 | 35 | 19:1 | 11,5 | 0.7 | 103 | 6.3 | 170 | 2 500 | 9,5–100 |
| 85754 | pump | 12 VDC | 28 | 60 | 19:1 | 11,5 | 0.7 | 103 | 6.3 | 345 | 5 000 | 9,5–100 |

¹⁾ overflow prevention system

Accessories

Drum cover, follower and valves assembly

| Order number | Description | Reservoir capacity | |
|--------------|------------------------------|--------------------|-----|
| | | gal | lb |
| 85474 | drum cover | 18 | 120 |
| 85492 | follower assembly | | |
| 85664 | vent valve assembly (24 VDC) | | |
| 272180 | strainer | | |
| 85475 | drum cover | 55 | 400 |
| 270982 | follower assembly | | |
| 85665 | vent valve assembly | | |

Vent valves

| Order number | Description |
|--------------|---|
| 274899 | 24 VDC vent valve, IP 67 explosion-proof rating |
| 276325 | 24 VDC vent valve, IP 65 rating |
| 276903 | 24 VDC vent valve, IP 65 rating |
| 276919 | hardware kit for 276903 |
| 525-32083-1 | 24 VDC vent valve, IP 54 rating |



Overview of oil and fluid grease metering devices

Single-line metering devices

| Product | Cate- gory ¹⁾ | Lubricant | | Metering quantity | | Operating pressure | | Relief pressure max. | | Adjustable metering quantity | Function type | Page |
|-----------------------------------|-----------------------------|-----------|--------------|-------------------------|-------------------------|--------------------|-----------|-------------------------|-----|------------------------------------|---------------------------------|------|
| | | oil | fluid grease | cm ³ /stroke | in ³ /stroke | bar | psi | bar | psi | | | |
| 341 | 2) ¹⁾ 1 | • | – | 0,01-0,16 | 0.0006-0.0097 | 6-80 | 87-1 160 | 1 ³⁾ 43.5 | – | – | prelubrication | 86 |
| 340 | 1 | • | – | 0,01-0,16 | 0.0006-0.0097 | 6-80 | 87-1 160 | 1 ³⁾ 43.5 | – | – | prelubrication | 88 |
| 361 | 1 | • | – | 0,02-0,10 | 0.0010-0.0060 | 8-40 | 116-1 160 | 1 14.5 | – | – | dynamic pulse type | 90 |
| 351 | 2) ¹⁾ 1 | • | – | 0,05-0,60 | 0.0030-0.0366 | 6-80 | 87-1 160 | 1 14.5 | – | – | prelubrication | 94 |
| 350 | 1 | • | – | 0,05-0,60 | 0.0030-0.0366 | 6-80 | 87-1 160 | 1 14.5 | – | – | prelubrication | 96 |
| 370 | 1 | • | – | 0,05-1,50 | 0.0030-0.0915 | 20-80 | 290-1 160 | 1 14.5 | – | – | relubrication | 98 |
| 391 | 1 | • | – | 0,20-1,50 | 0.0122-0.0915 | 8-45 | 116-653 | 1 14.5 | – | – | prelubrication | 100 |
| 390 | 1 | • | – | 0,20-1,50 | 0.0122-0.0915 | 8-80 | 116-1 160 | 1 14.5 | – | – | prelubrication | 102 |
| 321 G, T, W, Modul | 2 | • | • | 0,01-0,10 | 0.0006-0.0060 | 12-45 | 174-653 | 3 43.5 | – | – | special assembly arrangement | 104 |
| 321 G4, | 2 | • | • | 0,03-0,10 | 0.0118-0.0060 | 12-45 | 174-653 | 3 43.5 | – | – | special assembly arrangement | 104 |
| 361 | 2 | • | • | 0,01-0,20 | 0.0006-0.0122 | 8-80 | 116-1 160 | 3 43.5 | – | – | dynamic pulse type | 90 |
| 321 G7 | 2 | • | • | 0,01-0,30 | 0.0006-0.0183 | 12-45 | 174-653 | 3 43.5 | – | – | special assembly arrangement | 104 |
| AB | 2) ¹⁾ 2 | • | • | 0,01-0,60 | 0.0006-0.0366 | 18-50 | 261-725 | 3 43.5 | – | – | prelubrication | 106 |
| 341 | 2 | • | • | 0,03-0,10 | 0.0018-0.0061 | 6-80 | 87-1 160 | 3 43.5 | – | – | prelubrication | 86 |
| 340 | 2 | • | • | 0,03-0,10 | 0.0018-0.0061 | 6-80 | 87-1 160 | 3 43.5 | – | – | prelubrication | 88 |
| 310 | 2 | • | • | 0,03-0,16 | 0.0018-0.0097 | 12-38 | 174-551 | 3 43.5 | – | – | prelubrication | 92 |
| VN | 2 | – | • | 0,05-1,00 | 0.0030-0.0610 | 20-80 | 290-1 160 | 1 14.5 | – | – | prelubrication | 108 |
| 351 | 2 | • | • | 0,10-0,60 | 0.0061-0.0366 | 6-80 | 87-1 160 | 3 43.5 | – | – | prelubrication | 94 |
| 350 | 2 | • | • | 0,10-0,60 | 0.0061-0.0366 | 6-80 | 87-1 160 | 3 43.5 | – | – | prelubrication | 96 |
| Oi-AI-SR | 3 | • | • | 0,02-0,10 | 0.0012-0.0061 | 30-100 | 435-1 450 | 5 72.5 | – | – | cartridge arrangement | 110 |
| OS-33 | 3 | • | – | 0,01-2,82 | 0.0006-0.1720 | 15-75 | 217-1 088 | 5 75 | • | – | prelubrication | 120 |
| OS-4 | 3 | • | – | 0,01-2,00 | 0.0006-0.1220 | 15-75 | 217-1 088 | 5 75 | • | – | prelubrication | 120 |
| 391 | 3 | • | • | 0,10-0,30 | 0.0061-0.0183 | 8-45 | 116-653 | 7 101.5 | – | – | prelubrication | 100 |
| 390 | 3 | • | • | 0,10-0,30 | 0.0061-0.0183 | 8-45 | 116-653 | 7 101.5 | – | – | prelubrication | 102 |
| SL-42 | 4 | • | • | 0,016-0,049 | 0.001-0.0029 | 52-69 | 750-1 000 | 10 150 | • | – | prelubrication | 112 |
| SL-43 | 4 | • | • | 0,016-0,131 | 0.001-0.0080 | 52-69 | 750-1 000 | 10 150 | • | – | prelubrication | 114 |
| SL-41 | 4 | • | • | 0,13-1,31 | 0.0079-0.0799 | 52-69 | 750-1 000 | 10 150 | • | – | prelubrication | 116 |
| SL-44 | 4 | • | • | 0,13-1,31 | 0.0079-0.0799 | 52-69 | 750-1 000 | 10 150 | • | – | prelubrication | 118 |

1) The category allows a simple assignment of the metering device to a pump of the same category.
The category results from the relief pressure, the operating principle and the lubricant suitable for the metering device.
2) Stainless steel or C5M available
3) For the metering quantity version 0,01 cm³ and 0,02 cm³ max. relief pressure is 3 bar

Metering device

341



Description

Developed for installation in manifolds, series 341 single-port, prelubrication metering devices are suitable for use with single-line, centralized lubrication systems for oil and fluid grease. The combination of these metering devices with one- to six-port manifolds provides flexible options for lubrication system design. Manifolds customized for product series 341 are available in aluminum and stainless steel.

Features and benefits

- Suitable with manifolds having one to six ports to match number of lubrication points
- Provides flexible options for systems with remote single lubrication points or multiple-port metering devices with up to six ports
- Select optional push-in or screw-in type metering nipples for feed line connections via order code
- Choose separately manifold models with different thread sizes for main line connection and materials
- Current metering nipples above 0,03 cm³ are exchangeable to yield different output quantities

Applications

- Machine tools
- Printing machines
- Packaging industry
- Textile industry



Technical data

| | |
|-------------------------------|---|
| Function principle | Metering device |
| Outlets | 1 |
| Metering quantity | oil: 0,01 to 0,16 cm ³ 0,0006 to 0,0097 in ³ fluid grease: 0,03 to 0,10 cm ³ 0,0018 to 0,0061 in ³ |
| Lubricant | mineral and synthetic oil, 20 to 2 000 mm ² /s, 0,031 to 3,100 in ² /s fluid grease of NLGI 000, 00 |
| Operating temperature | 0 to +80 °C; +32 to 176 °F |
| Operating pressure | min. 6 bar, 87 psi max. 80 bar, 1 160 psi |
| Relief pressure ¹⁾ | max. 3 bar, 43,5 psi |
| Materials | steel (galvanized, Cr6-free), stainless steel, nickel-plated brass, brass, copper, FKM (FPM)/ NBR |
| Connection main line | pipe Ø 6 to 10 mm, solderless pipe connection for threads |
| Connection outlet | G 1/8; G 1/4; M10 × 1 or M14 × 1,5 pipe Ø 2,5 mm and Ø 4 mm; metering nipple (VS) with SKF Quick Connector, metering nipple (00) for solderless pipe connection |
| Dimensions | min. 43,5 × 12 mm; 1,713 × 0,472 in max. 53 × 12 mm; 2,086 × 0,472 in |
| Mounting position | any |

¹⁾ For oil metering quantity version 0,01 cm³ and 0,02 cm³ max. relief pressure is 3 bar



NOTE

Further technical information, technical drawings, accessories, spare parts or product function descriptions available on SKF.com/lubrication:

1-5001-EN



3D

skf-lubrication.partcommunity.com/3d-cad-models

Metering device

341

Identification code 3 4 1 - - - 0 0 0 0 - 0 0

Product series 3 4 1

Number of metering points (1) 0 0 0 0

Design and metering quantity

| Design code | 2 | 4 | 8 | 5 | 9 | 1 | 7 | 6 |
|-------------------------|------------------|------------------|------------------|------------------|--------------|----------------------|----------------------|----------------------|
| Lubricant | Oil | Oil | Oil | Fluid grease | Fluid grease | Oil | Fluid grease | Oil |
| Ø Outlet [mm] | 2,5 | 4 | 4 | 4 | 4 | 4 | 4 | 4 |
| Distributor body | Steel | Steel | Steel | Steel | Steel | Steel | Steel | Steel (1.4305) |
| Metering nipple | Brass | Brass | Brass | Brass (n.p.) | Brass (n.p.) | Brass | Brass (n.p.) | Steel (1.4305) |
| Elastomer | NBR | NBR | KFM (FPM) | NBR | FKM (FPM) | NBR | NBR | FKM (FPM) |
| Threaded seal | FW ²⁾ | FW ²⁾ | FW ²⁾ | FW ²⁾ | Flat | O-ring ³⁾ | O-ring ³⁾ | O-ring ³⁾ |
| Connection outlet | 00 | VS 00 | VS 00 | VS 00 | 00 | VS 00 | VS 00 | 00 |
| Metering quantity code | 1 | 1 | 1 | 1 | - | 1 | - | 1 |
| 0,01 cm ³ 1) | 1 | 1 | 1 | 1 | - | 1 | - | 1 |
| 0,02 cm ³ 1) | - | - | 6 | - | 6 | - | - | - |
| 0,03 cm ³ | 2 | 2 | 2 | 2 | 2 | 2 | 2 | 2 |
| 0,06 cm ³ | 3 | 3 | 3 | 3 | 3 | 3 | 3 | 3 |
| 0,10 cm ³ | 4 | 4 | 4 | 4 | 4 | 4 | 4 | 4 |
| 0,16 cm ³ | 5 | 5 | 5 | 5 | - | 5 | - | 5 |

1) Subsequent modification of the metering quantity is not technically possible.
 2) FW=Flat washer must be ordered separately. Order number: **DIN7603-A8x11.5-CU**
 3) O-ring is part of the shipment

Accessory

Manifold



Description

For 341 metering devices, VL-manifolds are utilized for one to six screw-in points with thread M8x1 mm for O-ring or flat (copper) washer sealing. Normal-profile manifolds are available in aluminum and stainless steel, while narrow-profile manifolds are offered in aluminum only.

Identification code V L - - - - -

Product series V L

Number of ports

- 01 = 1 screw-in point
- 02 = 2 screw-in points
- 03 = 3 screw-in points
- 04 = 4 screw-in points
- 05 = 5 screw-in points
- 06 = 6 screw-in points

(other numbers of ports available on request)

Design of metering device pipe thread

- A = Normal profile, M8x1 with counterbore for O-ring
- D = Small profile, M8x1 without counterbore

Material

- A = Aluminum
- E = Stainless steel (1.4305) (can only be selected for normal profile)

Design of main line connection

- G1 = G1/8 per DIN 3852-2, Form X, small
- G2 = G1/4 per DIN 3852-2, Form X, small
- M3 = M10x1 with counterbore for solderless pipe connection per DIN 3862
- M4 = M14x1,5 with counterbore for solderless pipe connection per DIN 3862 (can only be selected for normal profile)

Metering device

340



Description

Offered in two-, three- and five-port models, series 340 metering devices were developed for use with single-line, centralized lubrication systems for oil and fluid grease. These metering devices are designed for installation directly on the machine/system requiring lubrication. Series 340 metering devices can be ordered with fittings for the main line connection by selecting the appropriate order code.

Features and benefits

- Designed for installation directly on the machine/system requiring lubrication
- Select optional push-in or screw-in type metering nipples for feed line connections
- Choose optional push-in or screw-in type main line fittings
- Metering nipples above 0,03 cm³ are exchangeable to yield different output quantities

Applications

- Machine tools
- Printing machines
- Packaging industry
- Textile industry

Technical data

| | |
|-------------------------------|---|
| Function principle | metering device |
| Outlets | 2, 3 or 5 |
| Metering quantity | oil: 0,01 to 0,16 cm ³ 0,0006 to 0,0097 in ³ grease: 0,03 to 0,10 cm ³ 0,0018 to 0,0061 in ³ |
| Lubricant | mineral and synthetic oil, 20 to 2 000 mm ² /s and fluid grease NLGI 000, 00 |
| Operating temperature | 0 to +80 °C; +32 to +176 °F |
| Operating pressure | min. 6 bar, 87 psi; max. 80 bar, 1 160 psi |
| Relief pressure ¹⁾ | max. 3 bar, 43,5 psi |
| Materials | zinc die-cast, brass (oil), nickel-plated brass (fluid grease), copper, steel, FKM (FPM)/NBR |
| Connection main line | different fittings for pipe Ø 6 to 10 mm or closure plugs for thread M10×1 |
| Connection outlet | pipe Ø2,5 and Ø 4 mm metering nipple (VS) with SKF quick connector, metering nipple (00) for solderless pipe connection |
| Dimensions | min. 48 × 53 × 15 mm max. 99 × 58 × 15 mm min. 1.889 × 2.086 × 0.590 in max. 3.897 × 2.283 × 0.590 in |
| Mounting position | any |

¹⁾ For oil metering quantity version 0,01 cm³ and 0,02 cm³ max. relief pressure is 3 bar

NOTE

Further technical information, technical drawings, accessories, spare parts or product function descriptions available on SKF.com/lubrication:

1-5001-EN



3D

skf-lubrication.partcommunity.com/3d-cad-models

Metering device

361



Description

Designed for installation in manifolds, series 361 single-port, dynamic metering devices were developed for use with single-line, centralized lubrication systems for oil and fluid grease. When used in combination with one- to six-port manifolds, these metering devices provide flexible options for lubrication system design. Customized manifolds for series 361 metering devices are available in aluminum.

Features and benefits

- For use with manifolds having one to six ports to match number of lubrication points
- Designed for installation directly on the machine/system requiring lubrication
- Select screw-in type distributor with feed line connections via order code
- Choose separately optional manifold models with different thread sizes for main line connection

Applications

- Chain lubrication
- Transport and conveyor belts

Technical data

| | |
|-----------------------|--|
| Function principle | metering device |
| Outlets | 1 |
| Metering quantity | oil and fluid grease: 0,01 to 0,20 cm ³ ; 0.0006 to 0.012 in ³ synthetic oil: 0,02 to 0,10 cm ³ ; 0.001 to 0.006 in ³ |
| Lubricant | mineral and synthetic oil: 10 to 1 000 mm ² /s, 0.015 to 1.55 in ² /s fluid grease of NLGI 000, 00 |
| Operating temperature | 0 to +80 °C; +32 to +176 °F |
| Operating pressure | min. 8 bar, 116 psi max. 80 bar, 1 160 psi |
| Relief pressure | max. 3 bar; 43.5 psi |
| Materials | steel (galvanized, Cr6-free), (oil, grease), brass (oil), copper, flat washer (copper), NBR |
| Connection main line | pipe Ø 6 to 12 mm, 0.236 to 0.472 in; solderless pipe connection for threads G 1/8; G 1/4; M10×1 or M14×1,5 (DIN 3862) |
| Connection outlet | pipe Ø 4 mm straight compression nut fitting |
| Dimensions | min. 42 × 14 mm max. 46,5 × 14 mm min. 1.653 × 0.551 in max. 1.830 × 0.551 in |
| Mounting position | any |



NOTE

Further technical information, technical drawings, accessories, spare parts or product function descriptions available on SKF.com/lubrication:

1-5001-EN



3D

skf-lubrication.partcommunity.com/3d-cad-models

Metering device

361

Identification code 3 6 1 - 0 0 - 0 0 0 0 - 0 0

Product series 361

Number of metering points (1) 00

Design and metering quantity

| | | |
|------------------------|-------------------|-------|
| Design code | 1 | 2 |
| Lubricant | Oil, fluid grease | Oil |
| Ø Outlet [mm] | 4 | 4 |
| Distributor body | Steel, galvanized | Brass |
| Metering nipple | Steel, galvanized | Brass |
| Elastomer | NBR | NBR |
| Connection outlet | 00 | 00 |
| Metering quantity code | 1 | - |
| | 2 | 2 |
| | 3 | 3 |
| | 4 | 4 |
| | 5 | 5 |
| | 6 | - |

0,01 cm³
0,02 cm³
0,03 cm³
0,05 cm³
0,10 cm³
0,20 cm³

Flat washer must be ordered separately. Order number: 504-019

Accessory

Manifold



Description

For 361 metering devices, VL-manifolds are utilized for one to six screw-in points with thread M10x1 mm for flat washer sealing. Various main line connections can be selected via order code.

Identification code V L - [] [] [] [] [] []

Product series VL

Number of ports

| | |
|------------------------|------------------------|
| 01 = 1 screw-in point | 04 = 4 screw-in points |
| 02 = 2 screw-in points | 05 = 5 screw-in points |
| 03 = 3 screw-in points | 06 = 6 screw-in points |

(other numbers of ports available on request)

Design of metering device pipe thread

B = Normal profile, M10x1 with counterbore for flat washer or O-ring

Material

A = Aluminum E = Stainless steel (1.4305) (can only be selected for normal profile)

Design of main line connection

| | |
|---|---|
| G1 = G1/8 per DIN 3852-2, Form X, small | M4 = M14x1,5 with counterbore for solderless pipe connection per DIN 3862 (can only be selected for normal profile) |
| G2 = G1/4 per DIN 3852-2, Form X, small | |
| M3 = M10x1 with counterbore for solderless pipe connection per DIN 3862 | |

Metering device

310



Description

As the industry's first non-metallic metering device, SKF's Series 310 has a unique appearance. However, its sleek, contemporary design provides proven SKF reliability for a minimum of 400 000 lubrication cycles. Developed for pre-lubrication applications using oil and fluid grease, this metering device is simple to install utilizing plastic or metallic lines and can be mounted in either an upright or inverted position. It also features easily identifiable dosing elements to meet various lubrication requirements.

Features and benefits

- Suitable for use with plastic tubes or metal pipes
- Color-coded dosing elements to identify lubricant volumes
- Provides precise metering of lubricant
- Simple, flexible machine mounting in any position
- 2-, 3- or 5-port manifolds available
- Suitable for oil and fluid grease

Applications

- Machine tools
- Textile and wood industry
- Printing machines
- Conveyors



Technical data

| | |
|-----------------------|---|
| Function principle | metering device |
| Outlets | 2, 3 or 5 |
| Metering quantity | 0,03 to 0,16 cm ³ 0,0018 to 0,0097 in ³ |
| Lubricant | mineral and synthetic oil, 20 to 1 500 mm ² /s fluid grease: NLGI 00 and 000 |
| Operating temperature | +5 to +50 °C; +41 to +122 °F |
| Operating pressure | min. 12 bar, 174 psi max. 38 bar, 551 psi |
| Relief pressure | max. 3 bar; 43.5 psi |
| Materials | high-performance PA66 resin |
| Connection main line | fittings for Ø 6 mm lines |
| Connection outlet | fittings for Ø 4 mm lines |
| Dimensions | min. 68 × 70 × 20,5 mm max. 119 × 70 × 20,5 mm min. 2.67 × 2.75 × 8.07 in max. 4.68 × 2.75 × 8.07 in |
| Mounting position | any |



NOTE

Further technical information, technical drawings, accessories, spare parts or product function descriptions available on SKF.com/lubrication:

17505 EN



3D

skf-lubrication.partcommunity.com/3d-cad-models

Metering device

310

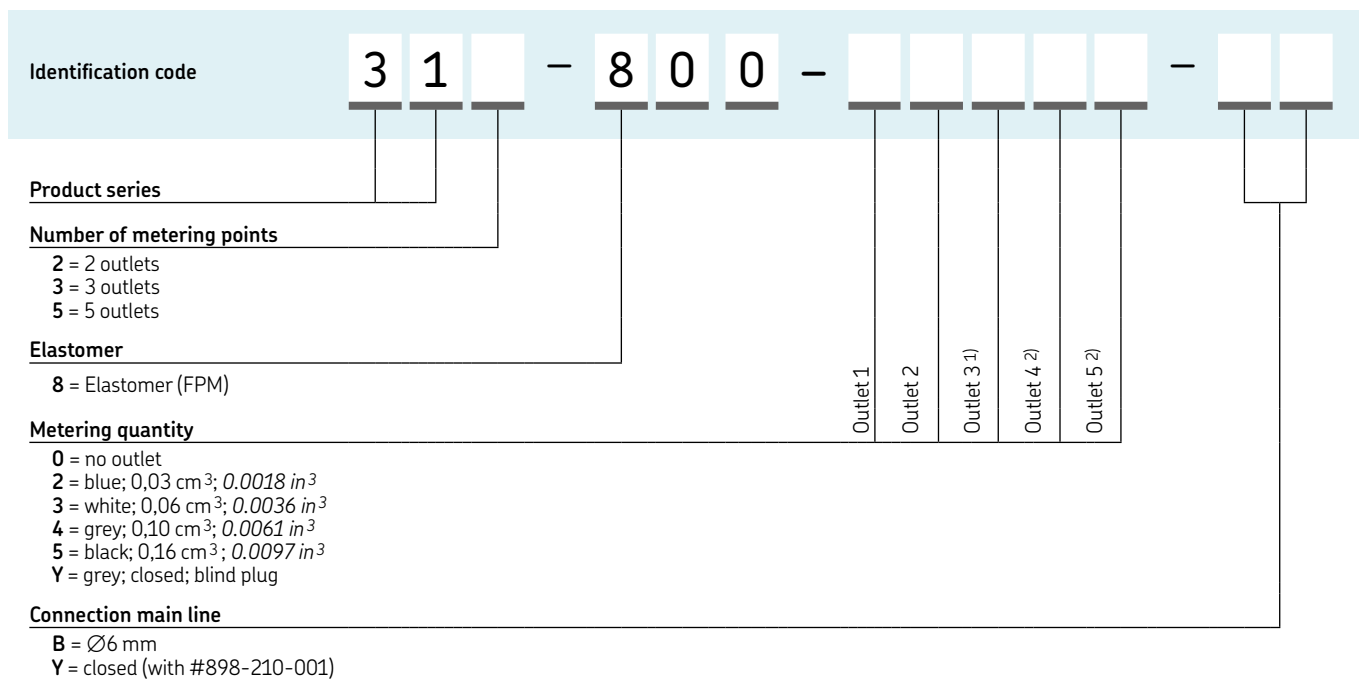

1) Not available for 2-outlet manifold 312 = 0
2) Not available for 2- and 3-outlet manifold 312 = 0; 313 = 0

Accessory

End-of-line plug



End-of-line plug

| Order number | Description |
|--------------|-----------------------|
| 898-210-001 | End-of-main-line plug |

Description

End-of-line plug suitable to plug main line outlet of 310 metering device to close the lubrication system. The red colour singalizes the end of the lubrication system.

Metering device

351



Description

Designed for installation in manifolds, series 351 single-port, pre-lubrication metering devices were developed for use with single-line, centralized lubrication systems for oil and fluid grease. When used in combination with one- to six-port manifolds, these metering devices provide flexible options for lubrication system design. Customized manifolds for series 351 metering devices are available in aluminum and stainless steel.

Features and benefits

- For use with manifolds having one to six ports to match number of lubrication points
- Provides flexible options for systems with remote single lubrication points or multiple-port metering devices with up to six ports
- Select optional push-in or screw-in type nipples for feed line connections
- Choose separately manifold models with different thread sizes for main line connection and materials
- Current metering nipples are exchangeable to yield different output quantities

Applications

- Machine tools
- Printing machines
- Packaging industry
- Textile industry

Technical data

| | |
|-----------------------|---|
| Function principle | metering device |
| Outlets | 1 |
| Metering quantity | oil: 0,05 to 0,60 cm ³ 0.0030 to 0.0366 in ³ fluid grease: 0,10 to 0,60 cm ³ 0.0061 to 0.0366 in ³ |
| Lubricant | mineral and synthetic oil, 20 to 2 000 mm ² /s and fluid grease NLGI 000, 00 |
| Operating temperature | 0 to +80 °C; +32 to +176 °F |
| Operating pressure | min. 6 bar, 87 psi max. 80 bar, 1 160 psi |
| Relief pressure | max. 3 bar, 43.5 psi |
| Materials | aluminum, stainless steel, brass (oil), nickel-plated brass (grease), flat washer (copper, stainless steel), FKM (FPM)/NBR |
| Connection main line | pipe Ø 6 to 12 mm solderless pipe connection for threads G 1/8; G 1/4; M10 × 1 or M14 × 1,5 (DIN 3862) |
| Connection outlet | pipe Ø 4 mm metering nipple (VS) with SKF Quick Connector - metering nipple (00) for solderless pipe connection |
| Dimensions | min. 43,5 × 12 mm; 1.713 × 0.472 in max. 53 × 12 mm; 2.086 × 0.472 in |
| Mounting position | any |



NOTE

Further technical information, technical drawings, accessories, spare parts or product function descriptions available on SKF.com/lubrication:

1-5001-EN



3D

skf-lubrication.partcommunity.com/3d-cad-models

Metering device

351

Identification code 3 5 1 - - - 0 0 0 0 - 0 0

Product series 3 5 1

Number of metering points (1) 0 0 0 0

Design and metering quantity

| Design code | 0 | 8 | 4 | 1 | 7 | 2 | 3 | 6 |
|------------------------|----------------------|------------------|------------------------------|------------------|------------------|----------------------|----------------------|----------------------|
| Lubricant | Oil | Oil | Oil | Fluid grease | Fluid grease | Oil | Fluid grease | Oil |
| Ø Outlet [mm] | 4 | 4 | 4 | 4 | 4 | 4 | 4 | 4 |
| Distributor body | Aluminum | Aluminum | Steel (1.4305) | Aluminum | Aluminum | Aluminum | Aluminum | Steel (1.4305) |
| Metering nipple | Brass | Brass | Steel (1.4305) | Brass (n.p.) | Brass (n.p.) | Brass | Brass (n.p.) | Steel (1.4305) |
| Elastomer | NBR | FKM (FPM) | FKM (FPM) | NBR | FKM (FPM) | NBR | NBR | FKM (FPM) |
| Threaded seal | FW ¹⁾ | FW ¹⁾ | Steel (1.4305) ²⁾ | FW ¹⁾ | FW ¹⁾ | O-ring ³⁾ | O-ring ³⁾ | O-ring ³⁾ |
| Connection outlet | VS 00 | VS 00 | 00 | VS 00 | VS 00 | VS 00 | VS 00 | 00 |
| Metering quantity code | 0,05 cm ³ | 3 3 | 3 3 | - | - | - | - | - |
| | 0,10 cm ³ | 4 4 | 4 4 | 4 | 4 | 4 | 4 | 4 |
| | 0,20 cm ³ | 5 5 | 5 5 | 5 | 5 | 5 | 5 | 5 |
| | 0,30 cm ³ | - | - | - | - | - | 6 6 | - |
| | 0,40 cm ³ | 6 6 | 6 6 | 6 | - | 6 6 | - | 6 |
| | 0,60 cm ³ | 7 7 | 7 7 | 7 | 7 | 7 | - | 7 |

¹⁾ FW=Flat washer must be ordered separately. Order number: 504-019
²⁾ Stainless steel ring must be ordered separately. Order number: 99-1031-7603
³⁾ O-ring is part of the shipment

Accessory

Manifold



Description

For 351 metering devices, VL-manifolds are utilized for one to six screw-in points with thread M10x1 mm for O-ring or flat (copper) washer sealing. Various main line connections can be selected via order code.

Identification code V L - - - - -

Product series V L

Number of ports

01 = 1 screw-in point 04 = 4 screw-in points
 02 = 2 screw-in points 05 = 5 screw-in points
 03 = 3 screw-in points 06 = 6 screw-in points
 (other numbers of ports available on request)

Design of metering device pipe thread

B = Normal profile, M10x1 with counterbore for flat washer or O-ring

Material

A = Aluminum E = Stainless steel (1.4305) (can only be selected for normal profile)

Design of main line connection

G1 = G1/8 per DIN 3852-2, Form X, small M4 = M14x1,5 with counterbore for solderless pipe connection per DIN 3862 (can only be selected for normal profile)
 G2 = G1/4 per DIN 3852-2, Form X, small
 M3 = M10x1 with counterbore for solderless pipe connection per DIN 3862

Metering device

350

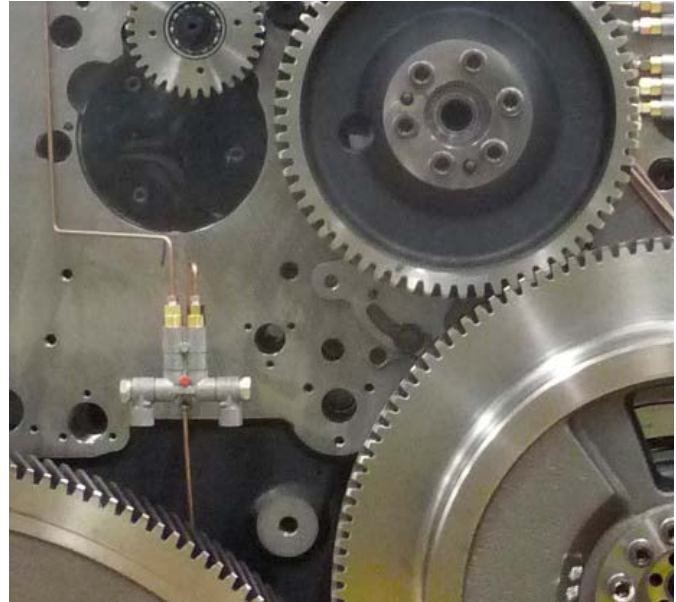

Description

Designed for installation directly on the machine/system requiring lubrication, series 350 single-line, prelubrication metering devices are available in two-, three- and five-port models. These metering devices were developed for use with single-line, centralized lubrication systems for oil and fluid grease. Series 350 metering devices can be ordered with fittings for the main line connection by selecting the appropriate order code.

Features and benefits

- For use with distributor bodies having two, three and five ports to match number of lubrication points
- Designed for installation directly on the machine/system requiring lubrication
- Select push-in or screw-in type metering nipples for feed line connection with metering device bodies
- Choose push-in or screw-in type main line fittings with metering device bodies
- Current metering nipples above 0,03 cm³ are exchangeable to yield different output quantities

Applications

- Machine tools
- Printing machines
- Packaging industry
- Textile industry
- Agriculture

Technical data

| | |
|-----------------------|--|
| Function principle | metering device |
| Outlets | 2, 3 or 5 |
| Metering quantity | oil: 0,05 to 0,60 cm ³ 0,003 to 0,037 in ³ grease: 0,10 to 0,60 cm ³ 0,0061 to 0,037 in ³ |
| Lubricant | mineral and synthetic oil, 20 to 2 000 mm ² /s and fluid grease NLGI 000, 00 |
| Operating temperature | 0 to +80 °C; +32 to +176 °F |
| Operating pressure | min. 6 bar, 87 psi; max. 80 bar, 1 160 psi |
| Relief pressure | max. 3 bar, 43,5 psi |
| Materials | zinc die-cast, brass (oil), nickel-plated brass (fluid grease), copper, steel, FKM (FPM)/NBR |
| Connection main line | different fittings for pipe Ø 6 to 10 mm; 0,236 to 0,393 in or closure plugs for thread M 12×1 |
| Connection outlet | pipe Ø 4 mm metering nipple (VS) with SKF Quick Connector - metering nipple (00) for solderless pipe connection |
| Dimensions | min. 46 × 83 × 18 mm max. 97 × 86 × 18 mm min. 1.811 × 3.267 × 0.708 in max. 3.818 × 3.385 × 0.708 in |
| Mounting position | any |



NOTE

Further technical information, technical drawings, accessories, spare parts or product function descriptions available on SKF.com/lubrication:

1-5001-EN



3D

skf-lubrication.partcommunity.com/3d-cad-models

Metering device

370



Description

Series 370 relubrication metering devices were developed for use with single-line, centralized lubrication systems for oil. Designed for installation directly on the machine/system requiring lubrication, these metering devices are available in two-, three- and five-port models. Series 370 metering devices can be ordered with fittings for the main line connection by selecting the appropriate order code.

Features and benefits

- For use with distributor bodies having two, three and five ports to match number of lubrication points
- Designed for installation directly on the machine/system requiring lubrication
- Choose optional metering nipples and push-in or screw-in type fittings for feed line connections
- Select SKF Quick Connector or screw-in type main line fittings
- Current metering nipples are easily exchangeable to yield different output quantities

Applications

- Machine tools
- Printing machines
- Packaging industry
- Textile industry



Technical data

| | |
|-----------------------|--|
| Function principle | metering device |
| Outlets | 2, 3 or 5 |
| Metering quantity | 0,05 to 1,50 cm ³ 0,003 to 0,091 in ³ |
| Lubricant | mineral and synthetic oil 20 to 2 000 mm ² /s 0,031 to 3,100 in ² /s |
| Operating temperature | -20 to +80 °C; -4 to +176 °F |
| Operating pressure | min. 20 bar; 290 psi max. 80 bar; 1 160 psi |
| Relief pressure | ≤1 bar, 14.5 psi |
| Materials | zinc die-cast, brass, copper, steel, NBR |
| Connection main line | different fittings for pipe Ø 6 to 12 mm; 0,236 to 0,472 in or closure plugs for thread M12×1 |
| Connection outlet | pipe Ø 4 mm; 0.16 in - metering nipple (VS) with SKF Quick Connector - metering nipple (00) for solderless pipe connection (DIN 3862) |
| Dimensions | min. 37 × 75 × 50,5 mm max. 88 × 75 × 56,5 mm min. 1.456 × 2.952 × 1.988 in max. 3.464 × 2.952 × 2.224 in |
| Mounting position | any |

NOTE

Further technical information, technical drawings, accessories, spare parts or product function descriptions available on SKF.com/lubrication:

1-5001-EN



3D

skf-lubrication.partcommunity.com/3d-cad-models

Metering device

391

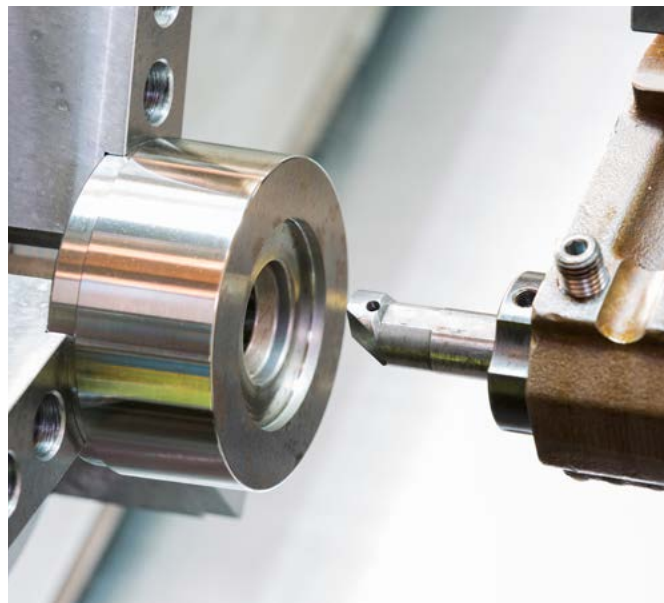

Description

Series 391 single-port prelubrication metering devices were developed for use with single-line, centralized lubrication systems for oil and fluid grease. Designed for installation in manifolds, these metering devices provide flexible system design when combined with one-to six-port manifolds. Customized manifolds for series 391 are available in aluminum.

Features and benefits

- For use with manifolds having one to six ports to match number of lubrication points
- Provides flexible options for systems with remote single lubrication points or multiple-port metering devices with up to six ports
- Select screw-in type metering nipples with feed line connections via order code
- Choose separately manifold models with different thread sizes for main line connection
- Current metering nipples are exchangeable to yield different output quantities

Applications

- Machine tools
- Printing machines
- Packaging industry
- Textile industry

Technical data

| | |
|-----------------------|---|
| Function principle | metering device |
| Outlets | 1 |
| Metering quantity | oil: 0,2 to 1,5 cm ³ ; 0.01 to 0.09 in ³ fluid grease: 0,1 to 0,3 cm ³ 0.006 to 0.02 in ³ |
| Lubricant | mineral and synthetic oil, 20 to 2 000 mm ² /s, fluid grease NLGI 000, 00 |
| Operating temperature | 0 to +80 °C; +32 to +176 °F |
| Operating pressure | min. 8 bar, 116 psi max. 45 bar, 653 psi |
| Relief pressure | max. 7 bar; 1 01.5 psi |
| Materials | aluminum, brass (oil), nickel-plated brass (fluid grease), copper, FKM (FPM)/NBR |
| Connection main line | pipe Ø 6 to 12 mm 0.236 to 0.472 in solderless pipe connection for threads G 1/8; G 1/4; M10×1 or M14×1,5 (DIN 3862) |
| Connection outlet | pipe Ø 4 mm; 0.16 in - metering nipple (00) for solderless pipe connection |
| Dimensions | min. 67,5 × 22 mm max. 78,5 × 22 mm min. 2.657 × 0.866 in max. 3.091 × 0.866 in |
| Mounting position | any |

NOTE

Further technical information, technical drawings, accessories, spare parts or product function descriptions available on SKF.com/lubrication:

1-5001-EN



3D

skf-lubrication.partcommunity.com/3d-cad-models

Metering device

390



Description

Series 390 prelubrication metering devices were developed for use with single-line, centralized lubrication systems for oil and fluid grease. Designed for installation directly on the machine/system requiring lubrication, these metering devices can be ordered with fittings for the main line connection by selecting the appropriate order code.

Features and benefits

- For use with distributor bodies having two or three ports to match number of lubrication points
- Designed for installation directly on the machine/system requiring lubrication
- Select screw-in type metering nipples for feed line connections
- Choose push-in or screw-in type main line fittings
- Current metering nipples are exchangeable to yield different output quantities

Applications

- Machine tools
- Printing machines
- Packaging industry
- Textile industry



Technical data

| | |
|-----------------------|---|
| Function principle | metering device |
| Outlets | 2 or 3 |
| Metering quantity | oil: 0,2 to 1,5 cm ³ 0.01 to 0.915 in ³ fluid grease: 0,1 to 0,3 cm ³ 0.006 to 0.0183 in ³ |
| Lubricant | mineral and synthetic oil 20 to 2 000 mm ² /s 0.031 to 3.100 in ² /s fluid grease of NLGI 000, 00 |
| Operating temperature | 0 to +80 °C; +32 to +176 °F |
| Operating pressure | min. 8 bar, 116 psi max. 45 bar, 653 psi |
| Relief pressure | max. 7 bar, 101.5 psi |
| Materials | zinc die-cast, brass (oil), nickel-plated brass (fluid grease), copper, steel, FKM (FPM)/NBR |
| Connection main line | different fittings for pipe Ø 6 to 12 mm; 0.236 to 0.472 in or closure plugs for thread M12×1 |
| Connection outlet | pipe Ø 4 mm; 0.16 in - metering nipple (00) for solderless pipe connection (DIN 3862) |
| Dimensions | min. 50 × 89 × 23 mm max. 71 × 89 × 23 mm min. 1.968 × 3.503 × 0.905 in max. 5.393 × 3.503 × 0.905 in |
| Mounting position | any |



NOTE

Further technical information, technical drawings, accessories, spare parts or product function descriptions available on SKF.com/lubrication:

1-5001-EN



3D

skf-lubrication.partcommunity.com/3d-cad-models

Metering device

390

Identification code: 3 9 - 0 0 - 0 0 -

Product series: 3 9

Number of metering points (2, 3): 0 0

Design and metering quantity

| Design code | 0 | 8 | 1 |
|------------------------|---------------|---------------|---------------|
| Lubricant | Oil | Oil | Fluid grease |
| Ø Outlet [mm] | 4 | 4 | 4 |
| Distributor body | Zinc die-cast | Zinc die-cast | Zinc die-cast |
| Metering nipple | Brass | Brass | Brass (n.p.) |
| Elastomer | NBR | FKM (FPM) | NBR |
| Connection outlet | 00 | 00 | 00 |
| Metering quantity code | | | |
| 0,10 cm ³ | - | - | 4 |
| 0,20 cm ³ | 5 | 5 | 5 |
| 0,30 cm ³ | - | - | 6 |
| 0,40 cm ³ | 6 | 6 | - |
| 0,60 cm ³ | 7 | 7 | - |
| 1,00 cm ³ | 8 | 8 | - |
| 1,50 cm ³ | 9 | 9 | - |
| closed* | V | V | V |

* V = Metering quantity of 0,20 cm³, closed

Fittings for main line connection

| Designation | Main line [mm] | Code |
|------------------------------------|----------------|------|
| Straight adapter | 6 | B |
| DIN 3862 with flat washer | 8 | C |
| | 10 | D |
| Banjo fitting DIN 3862 | 6 | E |
| with flat washer, lockable 1) | 8 | F |
| Screw plug with flat washer | - | H |
| | 6 | M |
| Straight adapter | 8 | N |
| with EO-2 functional nut | 10 | P |
| | 12 | R |
| Straight adapter | 6 | S |
| with SKF Quick Connector | 8 | T |
| Banjo fitting with | 6 | W |
| SKF Quick Connectors, not lockable | 8 | X |
| Without fitting (M12x1 thread) | - | Z |

1) Banjo bolt only inserted in delivery condition, not tightened

Accessory

Exchangeable metering nipples

Order numbers for metering nipples for oil (replaceable)

| Outlet Ø | | Material elastomer | Metering nipple | Metering quantity | | | | |
|----------|------|--------------------|-----------------|--|--|--|--|--|
| mm | in | | | 0,2 cm ³ 0.012 in ³ | 0,4 cm ³ 0.024 in ³ | 0,6 cm ³ 0.036 in ³ | 1,0 cm ³ 0.061 in ³ | 1,5 cm ³ 0.092 in ³ |
| 4 | 0.16 | NBR | brass | 391-020-K | 391-040-K | 391-060-K | 391-100-K | 391-150-K |
| 4 | 0.16 | FKM (FPM) | brass | 391-020-K-S8 | 391-040-K-S8 | 391-060-K-S8 | 391-100-K-S8 | 391-150-K-S8 |

Order numbers for metering nipples for fluid grease (replaceable)

| Outlet Ø | | Material elastomer | Metering nipple | Metering quantity | | |
|----------|------|--------------------|----------------------|---|---|---|
| mm | in | | | 0,10 cm ³ 0.006 in ³ | 0,20 cm ³ 0.012 in ³ | 0,30 cm ³ 0.018 in ³ |
| 4 | 0.16 | NBR | brass, nickel-plated | 391-010-K-S1 | 391-020-K-S1 | 391-030-K-S1 |

Metering device

321 G, T, W, G4, Module, G7



Description

Series 321 single-port prelubrication metering devices were developed for use with single-line, centralized lubrication systems for oil and fluid grease. These metering devices are designed for installation directly in a lubrication point, which eliminates feeding lubricant via a lubrication point line, as well as the lubrication line at the lubrication point. This can be beneficial where space is limited. Choose from six types to meet application requirements.

Features and benefits

- Specially designed, single-port metering device for prelubrication
- For direct connection to the main line
- No separate lubrication line and fittings are necessary
- Screw-in type can be monitored by a pressure switch in the main line; suitable for feed line \varnothing 4 mm (oil) and \varnothing 6 mm (fluid grease)

Applications

- Machine tools
- Printing machines
- Packaging industry
- Textile industry



NOTE

Further technical information, technical drawings, accessories, spare parts or product function descriptions available on SKF.com/lubrication:

1-5001-EN



3D

skf-lubrication.partcommunity.com/3d-cad-models

Technical data

| | |
|--------------------------|---|
| Function principle | metering device |
| Outlets | 1 |
| Metering quantity | Model G, G4, T, W, Modular: 0,01 to 0,10 cm ³ ; 0,0006 to 0,006 in ³ Model G7: 0,01 to 0,3 cm ³ 0,0006 to 0,018 in ³ |
| Lubricant | mineral and synthetic oil, 20 to 2 000 mm ² /s, 0,031 to 3.100 in ² /s fluid grease of NLGI 000, 00,0 |
| Operating temperature | 0 to +80 °C; +32 to +176 °F |
| Operating pressure | min. 12 bar, 174 psi max. 45 bar, 653 psi |
| Relief pressure | max. 3 bar, max. 43.5 psi |
| Materials | steel (galvanized, Cr6-free) or brass, NBR, G7 FKM (FPM) |
| Connection main line | different fittings for pipe \varnothing 6 to 10 mm; 0,236 to 0,393 in or closure plugs for thread M 10×1 |
| Connection outlet | pipe \varnothing 4 and \varnothing 6 mm; 0,157 to 0,236 in - straight compression nut fitting - solderless pipe union (DIN 3862) |
| Dimensions: 321 G | length: 50 mm; 1.968 in \varnothing : 16,2 mm; 0.638 in wrench size 14 mm |
| Dimensions: 321 W | length: 46 mm; 1.811 in width: 26 mm; 1.023 in \varnothing : 11,5 mm; 0.453 in wrench size 10 mm |
| Dimensions: 321 G4 | length: 40,5 mm; 1.594 in \varnothing : 19,6 mm; 0.771 in wrench size 17 mm |
| Dimensions: 321 T | length: 43 mm; 1.692 in width: 61 mm; 2.401 in \varnothing : 16,2 mm; 0.638 in wrench size 14 mm |
| Dimensions: 321 Module | \varnothing : 30 mm; 1.181 in height or thickness: 11 mm; 0.433 in |
| Dimensions: 321 G7 small | length: 30 mm; 1.181 in \varnothing : 10,3 mm; 0.405 in |
| Dimensions: 321 G7 large | length: 50 mm; 1.968 in \varnothing : 13,5 mm; 0.531 in |
| Mounting position | any |

Metering device

321 G, T, W, G4, Module, G7

| Order information | | | Outlet Ø | | Lubricant | | Metering quantity | | Pipe thread of lubrication point line |
|-------------------|-----------|-----------|----------|-------|-----------|--------------|-------------------|-----------------|---------------------------------------|
| Order number | | | mm | in | Oil | Fluid grease | cm ³ | in ³ | |
| 321 G | 321 T | 321 W | | | | | | | |
| 321-401G1 | – | – | 4 | 0.157 | • | – | 0,01 | 0.0006 | M8×1 taper |
| 321-401G2 | 321-401T2 | 321-401W2 | 4 | 0.157 | • | – | 0,01 | 0.0006 | M10×1 taper |
| 321-401G3 | – | – | 4 | 0.157 | • | – | 0,01 | 0.0006 | R 1/8 taper |
| 321-403G1 | 321-403T1 | 321-403W1 | 4 | 0.157 | • | – | 0,03 | 0.0018 | M8×1 taper |
| 321-403G2 | 321-403T2 | 321-403W2 | 4 | 0.157 | • | – | 0,03 | 0.0018 | M10×1 taper |
| 321-403G3 | 321-403T3 | 321-403W3 | 4 | 0.157 | • | – | 0,03 | 0.0018 | R 1/8 taper |
| 321-406G1 | 321-406T1 | 321-406W1 | 4 | 0.157 | • | – | 0,06 | 0.0036 | M8×1 taper |
| 321-406G2 | – | 321-406W2 | 4 | 0.157 | • | – | 0,06 | 0.0036 | M10×1 taper |
| 321-406G3 | 321-406T3 | 321-406W3 | 4 | 0.157 | • | – | 0,06 | 0.0036 | R 1/8 taper |
| 321-410G1 | 321-410T1 | 321-410W1 | 4 | 0.157 | • | – | 0,10 | 0.0061 | M8×1 taper |
| 321-410G2 | 321-410T2 | 321-410W2 | 4 | 0.157 | • | – | 0,10 | 0.0061 | M10×1 taper |
| 321-410G3 | 321-410T3 | 321-410W3 | 4 | 0.157 | • | – | 0,10 | 0.0061 | R 1/8 taper |
| 321-601G1 | – | – | 6 | 0.236 | • | • | 0,01 | 0.0006 | M8×1 taper |
| 321-601G2 | – | 321-601W2 | 6 | 0.236 | • | • | 0,01 | 0.0006 | M10×1 taper |
| – | – | 321-601W3 | 6 | 0.236 | • | • | 0,01 | 0.0006 | R 1/8 taper |
| 321-603G1 | 321-603T1 | 321-603W1 | 6 | 0.236 | • | • | 0,03 | 0.0018 | M8×1 taper |
| 321-603G2 | 321-603T2 | 321-603W2 | 6 | 0.236 | • | • | 0,03 | 0.0018 | M10×1 taper |
| 321-603G3 | 321-603T3 | 321-603W3 | 6 | 0.236 | • | • | 0,03 | 0.0018 | R 1/8 taper |
| 321-606G1 | – | 321-606W1 | 6 | 0.236 | • | • | 0,06 | 0.0036 | M8×1 taper |
| 321-606G2 | 321-606T2 | 321-606W2 | 6 | 0.236 | • | • | 0,06 | 0.0036 | M10×1 taper |
| 321-606G3 | 321-606T3 | 321-606W3 | 6 | 0.236 | • | • | 0,06 | 0.0036 | R 1/8 taper |
| 321-610G1 | 321-610T1 | 321-610W1 | 6 | 0.236 | • | • | 0,10 | 0.0061 | M8×1 taper |
| 321-610G2 | 321-610T2 | 321-610W2 | 6 | 0.236 | • | • | 0,10 | 0.0061 | M10×1 taper |
| 321-610G3 | 321-610T3 | 321-610W3 | 6 | 0.236 | • | • | 0,10 | 0.0061 | R 1/8 taper |

* Designs G, T, W elastomer material NBR

| Order numbers 321 G4, Module, G7 | | | | Outlet Ø | | Lubricant | | Metering quantity | |
|----------------------------------|------------|--------------|--------------|----------|-------|-----------|--------------|-------------------|-----------------|
| Order number | | | | mm | in | Oil | Fluid grease | cm ³ | in ³ |
| 321 G4 | 321 Module | 321 G7 small | 321 G7 large | | | | | | |
| – | 321-101 | 321-401G7 | – | 4 | 0.157 | • | • | 0,01 | 0.0006 |
| 321-403G4 | 321-103 | 321-403G7 | – | 4 | 0.157 | • | • | 0,03 | 0.0018 |
| – | – | 321-403G7-S8 | – | 4 | 0.157 | • | • | 0,03 | 0.0018 |
| 321-406G4 | – | 321-406G7 | – | 4 | 0.157 | • | • | 0,06 | 0.0036 |
| – | – | 321-406G7-S8 | – | 4 | 0.157 | • | • | 0,06 | 0.0036 |
| 321-410G4 | – | 321-410G7 | 321-610G7 | 4 | 0.157 | • | • | 0,10 | 0.0061 |
| – | – | 321-410G7-S8 | – | 4 | 0.157 | • | • | 0,10 | 0.0061 |
| – | – | – | 321-616G7 | 6 | 0.236 | • | • | 0,16 | 0.0098 |
| – | – | – | 321-620G7 | 6 | 0.236 | • | • | 0,20 | 0.0122 |
| – | – | – | 321-630G7 | 6 | 0.236 | • | • | 0,30 | 0.0180 |

Metering device

AB



Description

Designed for installation in manifolds, series AB single-port, pre-lubrication metering devices were developed for use with single-line, centralized lubrication systems for oil and fluid grease. When combined with one- to six-port manifolds, these metering devices provide flexibility in lubrication system design. The metering device body is available in steel and stainless steel versions with copper or stainless steel sealing rings.

Features and benefits

- For use with manifolds having one to six ports to match number of lubrication points
- Provides flexible options for systems with remote single lubrication points or multiple-port metering devices with up to six ports
- Virtually maintenance-free
- Select screw-in type metering device for feed line connection via order code
- Choose separately manifold models with different thread sizes for main line connection and materials

Applications

- Machine tools
- Printing machines
- Packaging industry
- Textile industry

Technical data

| | |
|-----------------------|--|
| Function principle | metering device |
| Outlets | 1 |
| Metering quantity | 0,01 to 0,60 cm ³ , 0,0006 to 0,04 in ³ |
| Lubricant | mineral and synthetic oil, 20 to 2 000 mm ² /s, 0,031 to 3,100 in ² /s, fluid grease of NLGI 000, 00 |
| Operating temperature | 0 to +80 °C; +32 to +176 °F |
| Operating pressure | min. 18 bar, 260 psi max. 50 bar, 725 psi |
| Relief pressure | max. 3 bar, 43,5 psi |
| Materials | steel (galvanized, Cr6-free), stainless steel, copper, steel, flat washer (copper, stainless steel), FKM (FPM) |
| Connection main line | pipe Ø 6 to 10 mm; 0,236 or 0,393 in; solderless pipe connection for threads G 1/8; G 1/4; M10×1 or M14×1,5 (DIN 3862) |
| Connection outlet | Connection outlet: pipe Ø 4 mm; 0,16 in, straight compression nut fitting |
| Dimensions | min. 43 × 14 mm max. 82,5 × 14 mm min. 1,692 × 0,551 in max. 1,228 × 0,551 in |
| Mounting position | any |



NOTE

Further technical information, technical drawings, accessories, spare parts or product function descriptions available on SKF.com/lubrication:

1-5001-EN



3D

skf-lubrication.partcommunity.com/3d-cad-models

Metering device

AB

Identification code 2 4 - 2 8 0 0 - 0

Product series AB

Lubricant
 5 = Oil/fluid grease, galvanized steel, copper ring
 9 = Oil/fluid grease, stainless steel, stainless steel ring

Metering quantity
 01 = 0,01 cm³, 0.0006 in³
 02 = 0,02 cm³, 0.0012 in³
 03 = 0,03 cm³, 0.0018 in³
 05 = 0,05 cm³, 0.0030 in³
 10 = 0,10 cm³, 0.0061 in³
 20 = 0,20 cm³, 0.0122 in³
 40 = 0,40 cm³, 0.0244 in³
 60 = 0,60 cm³, 0.0366 in³

Accessory

Manifold



Description

For series AB metering devices, VL-manifolds are utilized for one to six screw-in points with thread M 10x1 mm for flat (copper) washer sealing. Normal-profile manifolds are available in aluminum or stainless steel, while narrow-profile manifolds are offered only in aluminum. Various main line connections can be selected via order code.

Identification code V L -

Product series

Number of ports
 01 = 1 screw-in point 04 = 4 screw-in points
 02 = 2 screw-in points 05 = 5 screw-in points
 03 = 3 screw-in points 06 = 6 screw-in points
 (other numbers of ports available on request)

Design of metering device pipe thread
 B = Normal profile, M10x1 with counterbore for flat washer or O-ring

Material
 A = Aluminum E = Stainless steel (1.4305) (can only be selected for normal profile)

Design of main line connection
 G1 = G1/8 per DIN 3852-2, Form X, small
 G2 = G1/4 per DIN 3852-2, Form X, small
 M3 = M10x1 with counterbore for solderless pipe connection per DIN 3862
 M4 = M14x1,5 with counterbore for solderless pipe connection per DIN 3862
 (can only be selected for normal profile)

Metering device

VN



Description

Developed for use with single-line, centralized lubrication systems for fluid grease, series VN relubrication metering devices are offered with two, four or six ports. These metering devices were designed for installation directly on the vehicle or construction machine requiring lubrication. Series VN metering devices can be ordered with fittings for the main line connection via the appropriate order code.

Features and benefits

- Choose metering device with two, four or six points to match number of lubrication points
- Designed for installation directly on the vehicle/machine requiring lubrication
- Select metering nipples and push-in or screw-in type fittings for feed line or main line connections
- Easy metering adjustment by replacing metering nipples
- Black-coloured surface for optimized corrosion protection

Applications

- Commercial vehicles
- Construction machinery

Technical data

| | |
|-----------------------|---|
| Function principle | metering device |
| Outlets | 2, 4 or 6 |
| Metering quantity | 0,05 to 1,00 cm ³ 0,003 to 0,061 in ³ |
| Lubricant | fluid grease of NLGI 000, 00 |
| Operating temperature | -25 to +80 °C; -13 to +176 °F |
| Operating pressure | min. 20 bar; 290 psi max. 80 bar; 1 160 psi |
| Relief pressure | ≤1 bar; ≤14.5 psi |
| Materials | zinc die-cast, brass, steel, flat washer (copper), NBR |
| Connection main line | different fittings for pipe Ø 6 to 10 mm; 0,236 to 0,393 in or closure plugs for thread M8x1 |
| Connection outlet | pipe Ø 4 mm metering nipple (VS) with SKF Quick Connector - metering nipple (00) for solderless pipe connection |
| Dimensions | min. 62 × 83,5 × 52 mm max. 130,5 × 83,5 × 58 mm min. 2.440 × 3.287 × 2.047 in max. 5.118 × 3.287 × 2.283 in |
| Mounting position | any |

NOTE

Further technical information, technical drawings, accessories, spare parts or product function descriptions available on SKF.com/lubrication:

1-5001-EN



3D

skf-lubrication.partcommunity.com/3d-cad-models

Metering device

OI-AL-SR



Description

Developed for use in single-line, centralized lubrication systems, series OI-AL-SR single-port, prelubrication metering devices (cartridges) feature an integrated control pin and are designed for installation in manifolds or in base plates with up to 40 lubrication points. Three cartridge models with different fixed metering quantities provide flexible lubrication system design. Reduced feeding of main lines and feed lines in machines/systems saves on materials and installation costs.

Features and benefits

- Screw-in type, single-port metering device with cartridges for prelubrication
- For use with manifolds having one to eight ports or with base plates with up to 40 ports to match number of lubrication points
- Suitable for many lubrication points in constricted rooms
- All main line and feed line connections are located internally in the manifolds or base plates
- Simplifies installation, control function and replacement by use of one unit

Applications

- Glass industry

Technical data

| | |
|-----------------------|---|
| Function principle | metering device |
| Outlets | 1 |
| Metering quantity | 0,02; 0,05; 0,10 cm ³ ; 0,001; 0,003; 0,006 in ³ |
| Lubricant | mineral and synthetic oil, 22 to 1 000 mm ² /s, 0,034 to 1,55 in ² /s, fluid grease of NLGI 000, 00 |
| Operating temperature | +5 to 120 °C; +41 to 248 °F |
| Operating pressure | min. 30 bar; 435 psi max. 100 bar; 1 450 psi |
| Relief pressure | max. 5 bar; 72,5 psi |
| Material cartridge | aluminum |
| Material manifold | AlCuMgPb F37 DIN 1796 |
| Material base plate | AlMgSi1 F28-32 or AlCuMg1 F28 FKM (FPM) |
| Connection main line | SKF Quick Connector or solderless pipe connection for thread G 1/8 (F) |
| Connection outlet | SKF Quick Connector or solderless pipe connection for thread G 1/8 (F) |
| Dimensions | min. 120 × 35 × 105 mm max. 300 × 35 × 105 mm min. 4.72 × 1.38 × 4.13 in max. 11.81 × 1.38 × 4.13 in |
| Mounting position | any |



NOTE

Further technical information, technical drawings, accessories, spare parts or product function descriptions available on SKF.com/lubrication:

951-231-001

Metering device

OI-AL-SR

Order information

| Order number | Number of outlets | Metering quantity | | | | | | | | | | | | | | | |
|--------------|-------------------|-------------------|-----------------|-----------------|-----------------|-----------------|-----------------|-----------------|-----------------|-----------------|-----------------|-----------------|-----------------|-----------------|-----------------|-----------------|-----------------|
| | | Outlet 1 | | Outlet 2 | | Outlet 3 | | Outlet 4 | | Outlet 5 | | Outlet 6 | | Outlet 7 | | Outlet 8 | |
| | | cm ³ | in ³ | cm ³ | in ³ | cm ³ | in ³ | cm ³ | in ³ | cm ³ | in ³ | cm ³ | in ³ | cm ³ | in ³ | cm ³ | in ³ |
| 647-41151-2 | 2 | 0,02 | 0.001 | 0,02 | 0.001 | - | - | - | - | - | - | - | - | - | - | - | - |
| 647-41152-2 | 3 | 0,02 | 0.001 | 0,02 | 0.001 | 0,02 | 0.001 | - | - | - | - | - | - | - | - | - | - |
| 647-41152-4 | 3 | 0,10 | 0.006 | 0,05 | 0.003 | 0,05 | 0.003 | - | - | - | - | - | - | - | - | - | - |
| 647-41153-2 | 4 | 0,05 | 0.003 | 0,05 | 0.003 | 0,05 | 0.003 | - | - | - | - | - | - | - | - | - | - |
| 647-41154-4 | 5 | 0,02 | 0.001 | 0,02 | 0.001 | 0,02 | 0.001 | 0,02 | 0.001 | 0,02 | 0.001 | - | - | - | - | - | - |
| 647-41154-5 | 5 | 0,02 | 0.001 | 0,02 | 0.001 | 0,02 | 0.001 | 0,02 | 0.001 | - | - | - | - | - | - | - | - |
| 647-41154-7 | 5 | 0,02 | 0.001 | 0,05 | 0.003 | 0,05 | 0.003 | 0,05 | 0.003 | 0,05 | 0.003 | - | - | - | - | - | - |
| 647-41154-6 | 5 | 0,05 | 0.003 | 0,05 | 0.003 | 0,05 | 0.003 | 0,05 | 0.003 | - | - | - | - | - | - | - | - |
| 647-41155-2 | 6 | 0,10 | 0.006 | 0,05 | 0.003 | 0,05 | 0.003 | 0,05 | 0.003 | 0,05 | 0.003 | 0,05 | 0.003 | - | - | - | - |
| 647-41156-2 | 8 | 0,05 | 0.003 | 0,05 | 0.003 | 0,05 | 0.003 | 0,05 | 0.003 | 0,02 | 0.001 | 0,02 | 0.001 | 0,02 | 0.001 | - | - |

Accessories

Cartridges, manifolds and base plates

Cartridge



Manifold

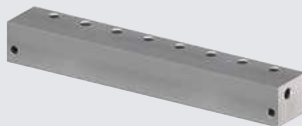

Base plate



Cartridges

| Order number | Metering quantity |
|--------------|------------------------------|
| 547-33924-1 | 0,02 cm ³ /stroke |
| 547-33925-1 | 0,05 cm ³ /stroke |
| 547-33926-1 | 0,10 cm ³ /stroke |

Manifolds

| Order number | Number of ports |
|--------------|-----------------|
| 447-71901-1 | 2 |
| 447-71902-1 | 3 |
| 447-71903-1 | 4 |
| 447-71904-1 | 5 |
| 447-71905-1 | 6 |
| 447-71906-1 | 8 |

Baseplates

| Order number | Number of ports |
|--------------|-----------------|
| 447-71899-1 | 40 |

Metering device

SL-42

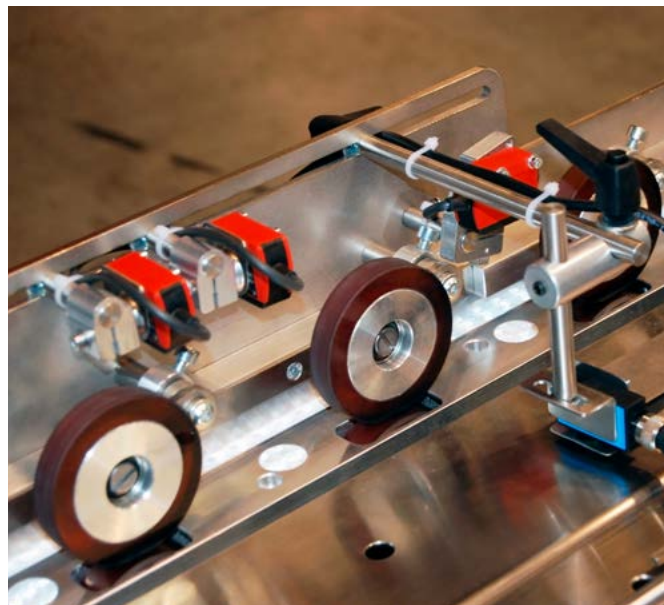

Description

Series SL-42 metering devices were developed for single-line, centralized lubrication systems dispensing oil or fluid grease. Lubricant output is externally adjustable, and the indicator stem permits a visual check of metering device operation. These carbon steel metering devices are available with nitrile or fluoroelastomer packings. Metering devices with fluoroelastomer packings (indicated by black adjustment caps) are used for applications requiring heat resistance or when a lubricant requires it for compatibility.

Features and benefits

- Screw-in type, single-port metering device for prelubrication affixed by adapter bolts
- Suitable for use with manifolds having one to 15 ports to match number of lubrication points
- Output is externally adjustable
- Indicator stem permits visual check of metering device operation
- May be combined in a circuit with SL-41, SL-43 and/or SL-44 metering devices
- Individual metering devices can be removed easily for inspection or replacement

Applications

- Paper converting
- Plastic processing
- Printing
- Packaging
- Metalworking
- Material handling equipment

Technical data

| | |
|-----------------------|--|
| Function principle | metering device |
| Outlets | 1 |
| Metering quantity | adjustable from 0,016 to 0,049 cm ³ , 0,001 to 0,003 in ³ |
| Lubricant | mineral and synthetic oil and fluid grease |
| Operating temperature | standard: -26 to +93 °C; -15 to +200 °F heat resistant: max. +176 °C; +350 °F |
| Operating pressure | min. 52 bar, 750 psi max. 70 bar, 1 000 psi |
| Relief pressure | < 10 bar, 150 psi |
| Materials | carbon steel, stainless steel, brass, steel, Nitrile (NBR) or fluoroelastomer (FKM, FPM) packings (indicated by black adjustment caps) (heat resistance application) |
| Connection main line | 1/8 NPTF (F) |
| Connection outlet | pipe 1/8 O.D connections ¹⁾ |
| Dimensions | min. 41 × 62 × 43 mm max. 308 × 62 × 43 mm min. 1.6 × 2.4 × 1.7 in max. 12.1 × 2.4 × 1.7 in |
| Mounting position | any |

¹⁾ Different adapters are possible → see accessories
Note: When using feed line tubing of 1/8 O.D. the feed line must not exceed a length of 7,5 m; 295 in based on oil +18 °C; +65 °F



NOTE

Further technical information, technical drawings, accessories, spare parts or product function descriptions available on SKF.com/lubrication.

Metering device

SL-42

Identification code

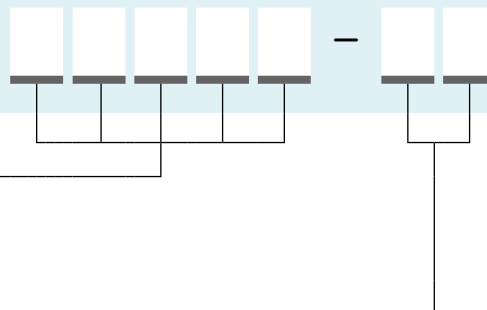

Product series

- 83311 = SL-42 standard with nitrile packings
- 84428 = SL-42 heat resistant with fluoroelastomer packings
- 85352 = SL-42 standard with nitrile packings for metric tube connection
O.D. 4 and 6 mm

Number of metering devices

- 1 = 1 metering device, mounted in a manifold
- 2 = 2 metering devices, mounted in a manifold
- 3 = 3 metering devices, mounted in a manifold
- 4 = 4 metering devices, mounted in a manifold
- 5 = 5 metering devices, mounted in a manifold
- 6 = 6 metering devices, mounted in a manifold
- 10 = 10 metering devices, mounted in a manifold
- 15 = 15 metering devices, mounted in a manifold

Accessories

Metering devices, manifolds and adapters

Metering device



Manifold



This picture shows a manifold example. Please note, the real manifold differs in terms of size and design.

Adapter



Replacement for manifold injectors

| Order number | Designation |
|--------------|---|
| 83535 | standard single metering device/no manifold, 1 outlet, 1/8 NPTF (M) inlet |
| 83313 | metering device for standard manifold |
| 84048 | metering device for heat-resistant manifold |
| 249649 | metric replacement injector |

Manifolds

| Order number ¹⁾ | Number of ports |
|----------------------------|-----------------|
| 91863-1 | 1 |
| 91864-1 | 2 |
| 91865-1 | 3 |
| 91866-1 | 4 |
| 14361 | 5 |
| 91976-1 | 6 |
| 14312 | 10 |
| 14253 | 15 |

¹⁾ Injectors, except replacement injectors for manifold, include compression nut and ferrule for tubing 1/8 in O.D. as standard. Injectors with manifolds include two mounting clips and screws.

G 1/8 to metric fitting adapters

| Order number | Pipe Ø mm | Material |
|--------------|-----------|-----------------|
| 249281 | 4 | steel |
| 249279 | 4 | stainless steel |
| 249282 | 6 | steel |
| 249280 | 6 | stainless steel |

Metering device

SL-43



Description

Series SL-43 metering devices were developed for single-line, centralized lubrication systems dispensing oil or fluid grease. Lubricant output is externally adjustable, and the indicator stem permits a visual check of metering device operation. These carbon steel metering devices are available with nitrile or fluoroelastomer packings. Metering devices with fluoroelastomer packings (indicated by black adjustment caps) are used for applications requiring heat resistance or when a lubricant requires it for compatibility.

Features and benefits

- Screw-in type, single-port metering device for prelubrication affixed by adapter bolts
- Suitable for use with manifolds having one to four ports to match number of lubrication points
- Output is externally adjustable
- Indicator stem permits visual check of metering device operation
- May be combined in a circuit with SL-41, SL-42 and/or SL-44 metering devices
- Individual metering devices can be removed easily for inspection or replacement

Applications

- Glass processing
- Paper converting
- Plastic processing
- Printing and packaging
- Metalworking
- Material handling equipment

Technical data

| | |
|-----------------------|--|
| Function principle | metering device |
| Outlets | 1 |
| Metering quantity | adjustable from 0,016 to 0,131 cm ³ 0.001 to 0.008 in ³ |
| Lubricant | mineral and synthetic oil |
| Operating temperature | standard: -26 to +93 °C; -15 to +200 °F heat resistant: max. +176 °C; +350 °F |
| Operating pressure | min. 52 bar, 750 psi max. 70 bar; 1 000 psi |
| Relief pressure | < 10 bar, 150 psi |
| Materials | carbon steel, stainless steel, brass, steel, Nitrile (NBR) or fluoroelastomer (FKM, FPM) packings (indicated by black adjustment caps) (heat resistance application) |
| Connection main line | 1/4 NPTF (F) |
| Connection outlet | pipe 1/8 O.D connections ¹⁾ |
| Dimensions | min. 44 × 79 × 52 mm max. 102 × 79 × 52 mm min. 1.7 × 3.1 × 2.0 in max. 4.0 × 3.1 × 2.0 in |
| Mounting position | any |

¹⁾ Different adapters are possible → see accessories
Note: When using feed line tubing of 1/8 O.D. the feed line must not exceed a length of 7,5 m; 295 in based on oil +18 °C; +65 °F

NOTE

Further technical information, technical drawings, accessories, spare parts or product function descriptions available on SKF.com/lubrication.

Metering device

SL-43

Identification code

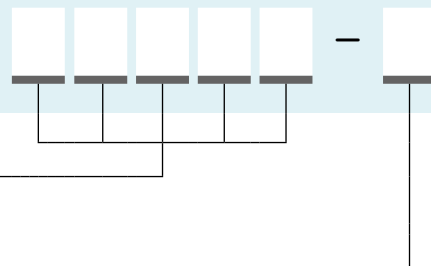

Product series

- 83661 = SL-43 standard with nitrile packings
- 84429 = SL-43 heat resistant with fluoroelastomer packings

Number of metering devices

- 1 = 1 metering device, mounted in a manifold
- 2 = 2 metering devices, mounted in a manifold
- 3 = 3 metering devices, mounted in a manifold
- 4 = 4 metering devices, mounted in a manifold

Accessories

Metering devices, manifolds and adapters

Metering device



Manifold



This picture shows a manifold example. Please note, the real manifold differs in terms of size and design.

Adapter



Replacement for manifold injectors

| Order number | Designation |
|--------------|---|
| 83662 | standard single metering device/no manifold, 1 outlet, 1/8 NPTF (M) inlet |
| 83660 | metering device for standard manifold |
| 84110 | metering device for heat-resistant manifold |

Manifolds

| Order number ¹⁾ | Number of ports |
|----------------------------|-----------------|
| 91883-1 | 1 |
| 91884-1 | 2 |
| 91885-1 | 3 |
| 91886-1 | 4 |

¹⁾ Injectors, except replacement injectors for manifold, include compression nut and ferrule for tubing 1/8 in O.D. as standard. Injectors with manifolds include two mounting clips and screws.

G 1/8 to metric fitting adapters

| Order number | Pipe Ø mm | Material |
|--------------|-----------|-----------------|
| 249281 | 4 | steel |
| 249279 | 4 | stainless steel |
| 249282 | 6 | steel |
| 249280 | 6 | stainless steel |

Metering device

SL-41



Description

Series SL-41 metering devices are designed for use in high-temperature applications, depending on the lubricant. These metering devices are available installed only in manifolds with 3/8-inch NPT female inlets and feature a tamper-resistant adjustment screw that does not incorporate a visual indicator.

Features and benefits

- Screw-in type, single-port metering device affixed by adapter bolts
- Suitable for use with manifolds having one to five ports to match number of lubrication points
- Output is externally adjustable.
- Individual injectors can be removed easily for inspection or replacement
- Carbon steel with fluoroelastomer packings

Applications

- Glass processing
- Metalworking



Technical data

| | |
|-----------------------|--|
| Function principle | metering device |
| Outlets | 1 to 5 |
| Metering quantity | adjustable from 0,13 to 1,31 cm ³ 0.008 to 0.0689 in ³ |
| Lubricant | mineral and synthetic oil |
| Operating temperature | standard: -26 to +93 °C; -15 to +200 °F heat resistant: max. +176 °C; +350 °F |
| Operating pressure | min. 52 bar; 750 psi max. 70 bar; 1 000 psi |
| Relief pressure | < 10 bar; 150 psi |
| Materials | carbon steel, FKM (FPM) |
| Connection main line | 3/8 NPTF (F) |
| Connection outlet | 1/8 NPTF (F) ¹⁾ |
| Dimensions | min. 63 × 163,5 × 52,4 mm max. 171 × 163,5 × 52,4 mm min. 2.5 × 6.4 × 2.1 in max. 6.75 × 6.4 × 2.1 in |
| Mounting position | any |

¹⁾ When using feed line tubing of 1/8 O.D., feed line must not exceed a length of 7,5 m; 295 in based on oil +18 °C; +64 °F 1/8 NPTF (F).

NOTE

Further technical information, technical drawings, accessories, spare parts or product function descriptions available on SKF.com/lubrication.

Metering device

SL-41

Identification code **8 2 2 9 4 -**

Product series
82294 = SL-41 heat resistant with fluoroelastomer packings

Number of metering devices
 1 = 1 metering device, mounted in a manifold
 2 = 2 metering devices, mounted in a manifold
 3 = 3 metering devices, mounted in a manifold
 4 = 4 metering devices, mounted in a manifold
 5 = 5 metering devices, mounted in a manifold

Accessories

Metering devices and manifolds

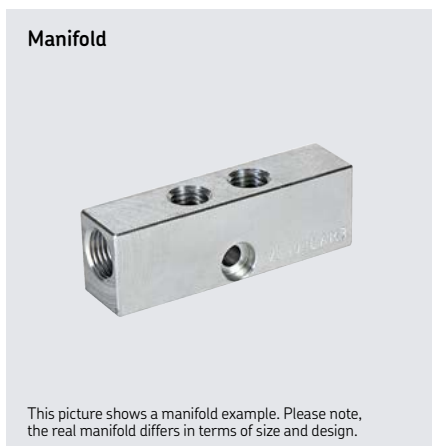

Replacement for manifold injectors

| Order number | Designation |
|--------------|---------------------------------------|
| 82295 | metering device for manifold NPTF (F) |
| 82292 | single metering device |

Manifolds

| Order number ¹⁾ | Number of ports |
|----------------------------|-----------------|
| 12658 | 1 |
| 11962 | 2 |
| 11963 | 3 |
| 11964 | 4 |
| 11965 | 5 |

¹⁾ Each injector has two outlets. One is closed by a closure plug, but can be used to increase outlet quantity combined with another injector.

Metering device

SL-44



Description

Series SL-44 metering devices were developed for single-line, centralized lubrication systems dispensing fluid or semi-fluid lubricants. Lubricant output is externally adjustable, and the indicator stem permits a visual check of metering device operation. These carbon steel metering devices feature fluoroelastomer packings. Metering devices with fluoroelastomer packings (indicated by black adjustment caps) are used for applications requiring heat resistance or when a lubricant requires it for compatibility.

Features and benefits

- Screw-in type, single-port metering device for prelubrication affixed by adapter bolts
- Suitable for use with manifolds having one to five ports to match number of lubrication points
- Output is externally adjustable
- Indicator stem permits visual check of operation
- May be combined in a circuit with SL-41, SL-42 and/or SL-43 metering devices
- Individual metering devices can be removed easily for inspection or replacement

Applications

- Glass processing
- Paper converting
- Plastic processing
- Printing
- Packaging
- Metalworking
- Material handling equipment



Technical data

| | |
|---------------------------------|--|
| Function principle | metering device |
| Outlets | 1 |
| Metering quantity | adjustable from 0,13 to 1,31 cm ³ , 0,008 to 0,080 in ³ |
| Lubricant | mineral and synthetic oil |
| Operating temperature | -26 to +93 °C; -15 to +200 °F |
| Operating pressure | min. 52 bar, 750 psi max. 70 bar, 1 000 psi |
| Relief pressure | < 10 bar, 150 psi |
| Materials | carbon steel, FKM (FPM) |
| Connection main line | 3/8 NPTF (F) |
| Connection outlet ¹⁾ | 1/8 NPTF (F) |
| Dimensions | min. 63 × 179,4 × 52,4 mm max. 171 × 179,4 × 52,4 mm min. 2.5 × 7.1 × 2.1 in max. 6.75 × 7.1 × 2.1 in |
| Mounting position | any |

¹⁾ When using feed line tubing of 1/8 O.D. the feed line must not exceed a length of 7,5 m; 295 in based on oil +18 °C; +65 °F

NOTE

Further technical information, technical drawings, accessories, spare parts or product function descriptions available on SKF.com/lubrication.

Metering device

SL-44

Identification code 8 3 7 4 9 - []

Product series
83749 = SL-44 heat resistant with fluoroelastomer packings

Number of metering devices

- 1 = 1 metering device, mounted in a manifold
- 2 = 2 metering devices, mounted in a manifold
- 3 = 3 metering devices, mounted in a manifold
- 4 = 4 metering devices, mounted in a manifold
- 5 = 5 metering devices, mounted in a manifold

Accessories

Metering devices and manifolds

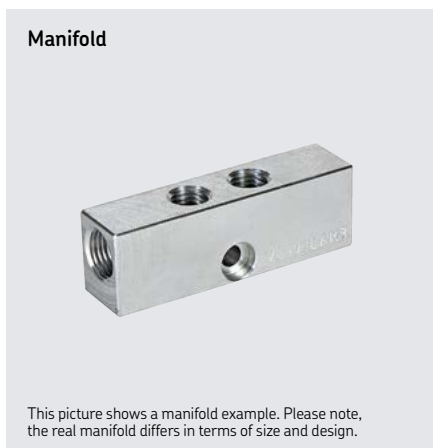

Replacement for manifold injectors

| Order number | Designation |
|--------------|---------------------------------------|
| 83748 | metering device for manifold NPTF (F) |

Manifolds

| Order number ¹⁾ | Number of ports |
|----------------------------|-----------------|
| 12658 | 1 |
| 11962 | 2 |
| 11963 | 3 |
| 11964 | 4 |
| 11965 | 5 |

¹⁾ Each injector has two outlets. One is closed by a closure plug, but can be used to increase outlet quantity combined with another injector.

Metering device

OS-33, OS-4



Description

OS series metering devices are intended to be used in single-line lubrication systems with oil. OS-33 is adjustable positive displacement metering device up to 2,8cm³ per shot and mainly used for heavy conveyor chain and sliding surface applications. For extremely long conveyors OS-4 might be used to have constant adjustable oil flow through entire pressurization time. Both types are often delivering oil via nozzle, brush or felt sold as an accessory. OS-33 and OS-4 metering devices can be installed to same up to six-port manifolds providing flexible system engineering and modifications.

Features and benefits

- Extends chain and sliding guide lifetime with sufficient lubrication
- Large oil volumes for heavy duty chains and slides
- Enables long main headers due high operation pressure
- Adjustable dosage or flow as needed per lubrication point
- Manifold design enabling flexible system configuration and maintenance
- Robust design for harsh environment

Applications

- Solid fuel power plants
- Saw and plywood mills
- Pulp and paper mills
- Agriculture

Technical data

| | |
|-----------------------|--|
| Function principle | metering device |
| Outlets | 1-6 |
| Metering quantity | adjustable |
| OS-33 | 0,01 to 2,82 cm ³ ; 0.0006 to 0.1720 in ³ |
| OS-4 | 0,01 to 2,10 cm ³ ; 0.0006 to 0.1282 in ³ |
| OS-4 | 25-500 cm ³ /min; 1.52 to 30.51 in ³ /min |
| Lubricant | mineral and synthetic oil 20-2 000 mm ² /s |
| Operating temperature | -25 to +120 °C; -13 to +248 °F |
| Operating pressure | 15-75 bar, 217-1 088 psi |
| Relief pressure | < 5 bar, 72 psi |
| Materials | mounting rails anodized aluminum or stainless steel dosers zinc plated mild steel or stainless steel |
| Connection main line | female thread G 1/4 |
| Connection outlet | lubrication pipe Ø6 mm |
| Dimensions | 50-185 x 26 x 140 mm 1.96-7.28 x 1.0 x 5.5 in |
| Mounting position | any |



NOTE

Further technical information, technical drawings, accessories, spare parts or product function descriptions available on SKF.com/lubrication.

Metering device

OS-33, OS-4

Order information

| Order number | Designation | Material |
|--------------|-------------|-------------------|
| 12394440 | OS-33-ZN-06 | zinc-coated steel |
| 12394355 | OS-3-SS-06 | stainless steel |
| 12394550 | OS-4-ZN-06 | zinc-coated steel |

Accessories

Manifolds, seals, felt holder and nozzles

Manifold



Nozzle for sliding surface



Lubrication felt

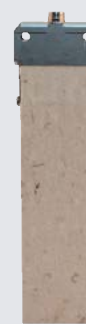

Manifolds

| Order number | Number of ports | Designation | Description |
|--------------|-----------------|-------------|----------------------|
| 12390350 | 1 | BPOS-01-AL | Mounting rail AL |
| 12390400 | 2 | BPOS-02-AL | Mounting rail AL |
| 12390450 | 3 | BPOS-03-AL | Mounting rail AL |
| 12390500 | 4 | BPOS-04-AL | Mounting rail AL |
| 12390550 | 5 | BPOS-05-AL | Mounting rail AL |
| 12390600 | 6 | BPOS-06-AL | Mounting rail AL |
| 12390610 | 2 | BPOS-02-SS | Stainless Steel rail |
| 12390615 | 4 | BPOS-04-SS | Stainless Steel rail |
| 12390620 | 6 | BPOS-06-SS | Stainless Steel rail |

Seals, felt holder and nozzles

| Order number | Designation | Description |
|--------------|--------------------|------------------------------|
| 12394400 | OS-3-4 SOCKET | Socket wrench tool |
| 12394580 | OS-3-KIT1 seal kit | Seal kit for OS-3 |
| 12394590 | OS-4-KIT1 seal kit | Seal kit for OS-4 |
| 12395360 | OSH-50-200-G/1/8 | Lubrication felt 50mm |
| 12395365 | OSH-150-200-G/1/8 | Lubrication felt 150mm |
| 12802580 | OSB-1-BR-0 | Flexible felt holder |
| 12802540 | OSB-1-BR-45 | Flexible felt holder 45deg |
| 12802560 | OSB-1-BR-90 | Flexible felt holder 90deg |
| 12802500 | OSN-40-ZN | Sliding surface nozzle 40mm |
| 12802520 | OSN-70-ZN | Sliding surface nozzle 70mm |
| 12802522 | OSN-120-ZN | Sliding surface nozzle 120mm |



Overview of grease metering devices

Single-line metering devices

| Product | Cate- gory ¹⁾ | Lubricant grease NLGI | | | Metering quantity | | Operating pressure max. | | Relief pressure max. | | Adjustable metering quantity | Function type | Page |
|-----------------|-----------------------------|-----------------------------|-------|------------|-------------------------|-------------------------|----------------------------|--------------------------------------|--|--------|------------------------------------|---------------|------|
| | | 0 | 1 | 2 | cm ³ /stroke | in ³ /stroke | bar | psi | bar | psi | | | |
| SL-33 | 2) | 5 | • • – | 0,016–0,05 | 0.001–0.0030 | 83–240 | 1 200–3 500 | 14 | 200 | • | prelubrication | 124 | |
| B-doser | 2) | 5 | • • – | 0,02–0,50 | 0.0012–0.0305 | max. 150 | max. 2 180 | 15 ³⁾ | 218 ³⁾ | • | prelubrication | 126 | |
| LG-doser | 2) | 5 | • • – | 0,02–0,50 | 0.0012–0.0305 | max. 150 | max. 2 180 | 10 ³⁾ | 145 ³⁾ | • | prelubrication | 128 | |
| SL-32 | 2) | 6 | • • • | 0,016–0,13 | 0.001–0.008 | 83–240 | 1 200–3 500 | 14 | 200 | • | prelubrication | 130 | |
| SL-32 HV | 2) | 6 | • • • | 0,016–0,13 | 0.001–0.008 | 83–240 | 1 200–3 500 | 28 | 400 | • | prelubrication | 132 | |
| SL-1 | 2) | 6 | • • • | 0,13–1,31 | 0.0079–0.0799 | 127–240 | 1 850–3 500 | 41 | 600 | • | prelubrication | 133 | |
| QSL | 2) | 7 | • • • | 0,05–0,40 | 0.0030–0.0244 | 140–300 | 2 030–4 350 | 60 | 870 | • | prelubrication | 134 | |
| VR | 2) | 7 | • • • | 0,10–1,30 | 0.0061–0.0793 | 100–315 | 1 450–4 570 | 30 ³⁾ 70 ³⁾ | 435 ³⁾ 1 000 ³⁾ | • • | prelubrication prelubrication | 136 | |
| SLC | | 7 | • • • | 0,10–1,40 | 0.0061–0.0840 | 150–315 | 2 175–4 570 | 68 | 990 | • | prelubrication | 138 | |
| SL-11 | | 7 | • • • | 0,82–8,20 | 0.0500–0.5002 | 70–240 | 1 000–3 500 | 55 | 800 | • | prelubrication | 140 | |
| SL-V | | 7 | • • • | 0,25–1,31 | 0.0152–0.0799 | 128–413 | 1 850–6 000 | 70 | 1 000 | • | prelubrication | 141 | |
| SL-V XL | | 7 | • • • | 0,25–5,00 | 0.0152–0.3050 | 128–413 | 1 850–6 000 | 70 | 1 000 | • | prelubrication | 142 | |

¹⁾ The category allows a simple assignment of the metering device to a pump of the same category. The category results from the relief pressure, the operating principle and the lubricant suitable for the metering device.

²⁾ Stainless steel or C5M available

³⁾ Depending on design

Metering device

SL-33



Description

The series SL-33 metering devices are for single-line, high-pressure centralized lubrication systems dispensing petroleum-based lubricants with a viscosity up to NLGI 2. Output is externally adjustable. Its indicator stem permits visual check of metering device operation. May be combined in a circuit of metering devices SL-32, SL-V, SL-V XL, SL-1 and/or SL-11. Individual metering devices can be removed easily for inspection or replacement. Available in stainless steel SAE 304 for applications where environmental conditions are hazardous to carbon steel or in industries preferring stainless steel.

Features and benefits

- For use with manifolds from 1 to 7 ports to match number of lube points
- Output is externally adjustable
- Can be removed easily for inspection or replacement

Applications

- Food and beverage

Technical data

| | |
|-----------------------|---|
| Function principle | metering device |
| Outlets | 1 to 4 |
| Metering quantity | 0,016 to 0,049 cm ³ 0.001 to 0.003 in ³ |
| Lubricant | grease NLGI 0, 1 |
| Operating temperature | max. +93 °C; +200 °F |
| Operating pressure | 83 to 240 bar, 1 200 to 3 500 psi typical: 100 bar, 1 500 psi |
| Relief pressure | 14 bar, 200 psi |
| Materials | carbon steel, stainless steel 304 |
| Connection main line | 1/8 NPTF (F), 1/8 NPTF (M) |
| Connection outlet | 1/8 in O.D. tube |
| Lubricant point | solderless pipe connection (DIN 3862) or plug connector |
| Dimensions | min. 41 × 62 × 43 mm max. 156 × 62 × 43 mm min. 1.6 × 2.4 × 1.7 in max. 6.1 × 2.4 × 1.7 in |
| Mounting position | any |

Metering devices, except replacement metering devices for manifold, include compression nut and ferrule for tubing, 3,175 mm (0.125 in) O.D. as standard. Other outlet connectors for feed line optional; metering devices with manifolds include two mounting clips and screws; metering devices have nitrile packings. Check packing compatibility with synthetic lubricants. Injector output is controlled by position of indicator cap. Indicator cap limits travel of indicator piston.

To achieve advertised minimum output setting 0,016 cm³ (0.001 in³) hand tighten indicator cap against stop then loosen approximately 1/2 turn. Retracting indicator cap two full turns from hand tight position permits maximum output of 0,049 cm³ (0.003 in³) to be dispensed. Use graduations on cap as an aid in setting indicator. When injector has been adjusted for proper lubricant output, lock nut is tightened against face of indicator cap.

NOTE

Further technical information, technical drawings, accessories, spare parts or product function descriptions available on SKF.com/lubrication:
Form 404244

Metering device

SL-33

Order information

| Order number | Designation | Material | Number of outlets | Manifold inlet |
|--------------|--|---------------------|-------------------|----------------|
| 83309-1 | metering device including manifold | carbon steel | 1 | 1/8 NPTF (F) |
| 83309-2 | metering device including manifold | carbon steel | 2 | 1/8 NPTF (F) |
| 83309-3 | metering device including manifold | carbon steel | 3 | 1/8 NPTF (F) |
| 83309-4 | metering device including manifold | carbon steel | 4 | 1/8 NPTF (F) |
| 83309-5 | metering device including manifold | carbon steel | 5 | 1/8 NPTF (M) |
| 83309-6 | metering device including manifold | carbon steel | 6 | 1/8 NPTF (F) |
| 83900 | single metering device, no manifold needed | carbon steel | 1 | 1/8 NPTF (M) |
| 83314 | single metering device for replacement | carbon steel | – | – |
| 83715-1 | metering device including manifold | stainless steel 304 | 1 | 1/8 NPTF (F) |
| 83715-2 | metering device including manifold | stainless steel 304 | 2 | 1/8 NPTF (F) |
| 83715-3 | metering device including manifold | stainless steel 304 | 3 | 1/8 NPTF (F) |
| 83715-4 | metering device including manifold | stainless steel 304 | 4 | 1/8 NPTF (F) |
| 83715-6 | metering device including manifold | stainless steel 304 | 6 | 1/8 NPTF (F) |
| 83715-7 | metering device including manifold | stainless steel 304 | 7 | 1/8 NPTF (F) |
| 83900-9 | single metering device, no manifold needed | stainless steel 304 | 1 | 1/8 NPTF (M) |
| 83314-9 | single metering device for replacement | stainless steel 304 | – | – |

Metering device

B-doser



Description

B-dosers are used in single-line, heavy vehicle and industrial lubrication applications. The doser group consists of a manifold (mounting rail) with one or more dosers attached to it. B-dosers are made of zinc-coated steel. The dosage of B-dosers range from 20 to 500 mm³. Mounting rails are offered made of zinc-coated steel and made of stainless steel. Both elements of the dosing group as well as accessories have to be ordered by separated part numbers or identification codes.

Features and benefits

- The output quantity of the used dosers is visible on amount of notches at the housing
- Suitable with optionally manifold sizes for 2-, 3- and 6-ports to match amount of lube points (1-6)
- Optional stainless steel AISI 303 manifolds
- Suits for Ø8 mm feed lines

Applications

- Heavy vehicles
- Heavy industrial application



Technical data

| | |
|---------------------------------|---|
| Function principle | metering device |
| Outlets | 1 to 6 |
| Metering quantity | 0,02 to 0,50 cm ³ 0,0012 to 0,0305 in ³ |
| Lubricant | oil and grease NLGI 000 to 1 |
| Operating temperature | -25 to +80 °C; -13 to +176 °F |
| Operating pressure | max. 150 bar; 2 180 psi |
| Relief pressure | B1, B2=15 bar; 218 psi B3, B4=10 bar; 145 psi B5, B6=5 bar; 72 psi |
| Materials | |
| B-dosers | zinc-coated steel |
| Manifolds (rails) | zinc-coated steel or stainless steel |
| Connection main line (manifold) | R 1/4 for Ø 8 mm or pipe Ø 1/2 in |
| Connection outlet | 4 mm, 6 mm or 1/8 NPT(F) |
| Lubricant point | solderless pipe connection (DIN 3862) |
| Dimensions | min. 15 × 90 × 15 mm max. 17 × 110 × 17 mm min. 0.6 × 3.5 × 0.6 in max. 0.7 × 4.3 × 0.7 in |
| Mounting position | any |



NOTE

Further technical information, technical drawings, accessories, spare parts or product function descriptions available on SKF.com/lubrication:

11276 EN

Metering device

B-doser

Identification code B - G 1 / 8 - Z N - []

Product series []

Metering quantity

- 1 = 0,02 cm³, 0.0012 in³
- 2 = 0,05 cm³, 0.0030 in³
- 3 = 0,10 cm³, 0.0061 in³
- 4 = 0,15 cm³, 0.0091 in³
- 5 = 0,20 cm³, 0.0122 in³
- 6 = adjustable 0,2 to 0,5 cm³; 0.012 to 0.03 in³

Mounting rail fitting

G1/8 = G1/8 fitting

Material

ZN = zinc-coated steel

Lubricant outlet

- 4 = connector for Ø 4 mm pipe
- 6 = connector for Ø 6 mm pipe
- U = female thread NPT 1/8

Accessory

Manifold



Description

For B-doser metering devices, manifolds utilized are for 1 to 6 screw-in points with thread G 1/8 for O-ring sealing. Mainline fitting for G 1/4 for Ø 8 mm or pipe Ø 1/2 in. Normal profile and opposite-side profile design manifolds are available in zinc-coated steel. Various designs of main line and feed line connection can be selected by order code.

Identification code B P L D - [] - []

Manifold []

Size

- 02 = 2-place mounting rail
- 04 = 4-place mounting rail
- 06 = 6-place mounting rail

- 0202 = 4-place mounting rail, 2 places on opposite sides*
- 0303 = 6-place mounting rail, 3 places on opposite sides
- 0404 = 8-place mounting rail, 4 places on opposite sides*
- 0808 = 16-place mounting rail, 8 places on opposite sides*

- 0202T = 4-place mounting rail, 2 places on opposite sides, for end of line*
- 0303T = 6-place mounting rail, 3 places on opposite sides, for end of line*
- 0404T = 8-place mounting rail, 4 places on opposite sides, for end of line*
- 0606T = 12-place mounting rail, 6 places on opposite sides, for end of line*

Material

- ZN = zinc-coated steel
- S = stainless steel (AISI303)

* Not available in stainless steel material design

Metering device

LG-doser

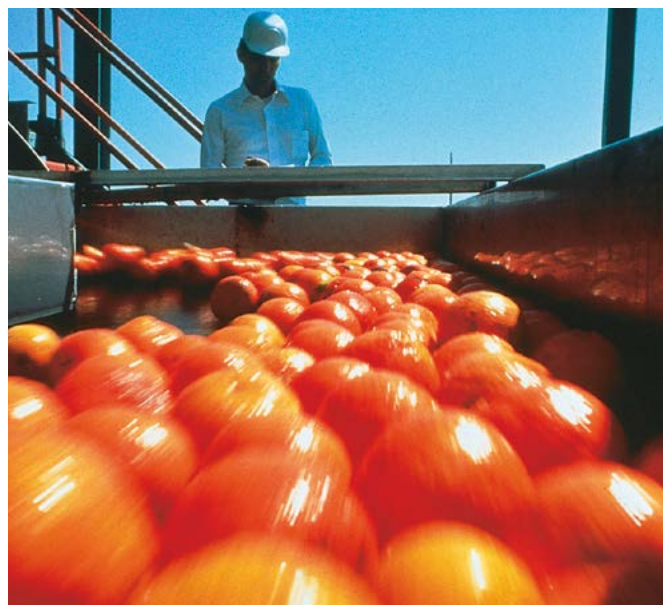

Description

LG-dosers are used in single-line lubrication applications. The doser group consists of a mounting rail with one or more dosers attached to it. Dosing modules and mounting rails are made of stainless steel.

Features and benefits

- Two adjustable doser sizes are selectable by the used output quantity
- Manifold material: stainless steel AISI 303
- Compatible with screw-in type fittings for dosers and manifolds
- Suitable for feed line \varnothing 4 and \varnothing 6 mm
- Robust and reliable

Applications

- Food and beverage

Technical data

| | |
|---------------------------------|--|
| Function principle | metering device |
| Outlets | 1 to 6 |
| Metering quantity | 0,02 to 0,50 cm ³ 0,0012 to 0,0305 in ³ |
| Lubricant | oil and grease NLGI 000 to 1 |
| Operating temperature | -25 to +80 °C; -13 to +176 °F |
| Operating pressure | max. 150 bar; 2 180 psi |
| Relief pressure | LG001 = 10 bar; 145 psi LG002 = 5 bar; 72 psi |
| Materials | stainless steel AISI 304 |
| Connection main line (manifold) | R 1/4 in |
| Connection outlet | pipe connector \varnothing 4 and 6 mm or pipe \varnothing 1/4 in |
| Connection lubricant point | solderless pipe connection (DIN 3862) |
| Materials | stainless steel AISI 303 |
| Dimensions | min. 15 × 112 × 15 mm max. 17 × 110 × 17 mm min. 0.6 × 4.4 × 0.6 in max. 0.7 × 4.3 × 0.7 in |
| Mounting position | any |



NOTE

Further technical information, technical drawings, accessories, spare parts or product function descriptions available on SKF.com/lubrication:

1276 EN

Metering device

LG-doser

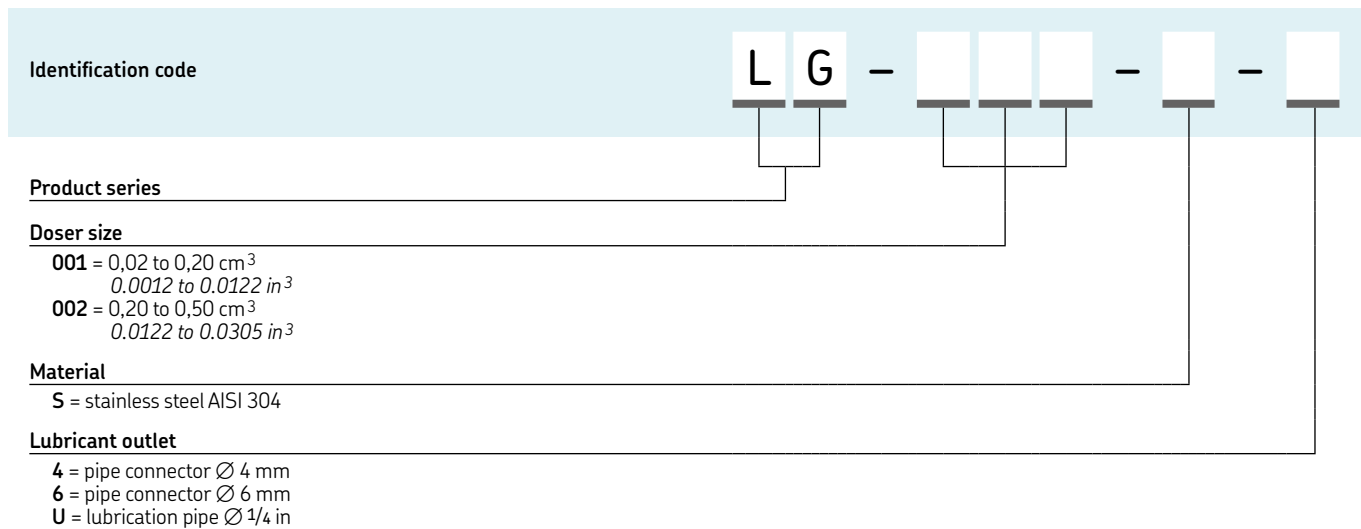

Accessory

Manifold



Description

For LG-doser metering devices, manifolds utilized are for 1 to 6 screw-in points with thread G 1/8 for O-ring sealing. Normal profile and opposite-side profile design manifolds are available in stainless steel AISI 303. Various designs of main line and feed line connections can be selected by order code.

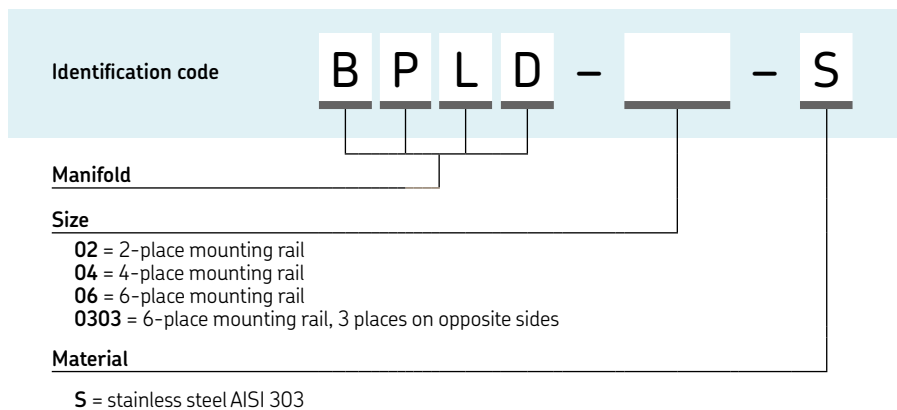

Metering device

SL-32



Description

The series SL-32 metering devices are for single-line, high-pressure centralized lubrication systems dispensing petroleum-based lubricants with a viscosity up to NLGI 2 (refer to Design Guide). Output is externally adjustable. The indicator stem permits visual check of metering device operation. Individual metering devices can be removed easily for inspection or replacement.

Features and benefits

- Shipped with manifolds from 1 to 4 ports to match number of lube points
- Output is externally adjustable
- Indicator stem permits visual check of operation
- Can be removed easily for inspection or replacement
- Available in stainless steel SAE 304

Applications

- Industrial automation
- Food and beverage
- Mobile on-road
- Pulp and paper
- Heavy industry
- Machine tools
- Construction
- Wind energy
- Oil and gas
- Forestry
- Marine



Technical data

| | |
|-----------------------|---|
| Function principle | metering device |
| Outlets | 1 to 4 |
| Metering quantity | 0,016 to 0,131 cm ³ 0,001 to 0,008 in ³ |
| Lubricant | grease NLGI 0, 1, 2 |
| Operating temperature | max. +93 °C; +200 °F |
| Operating pressure | 83 to 240 bar, 1 200 to 3 500 psi |
| Relief pressure | 14 bar, 200 psi |
| Material | carbon steel, stainless steel (304) |
| Connection main line | 1/4 NPTF (F), 1/4 NPTF (M) |
| Connection outlet | 1/8 in O.D. tube |
| Lubricant point | solderless pipe connection (DIN 3862) |
| Dimensions | min. 44 x 52 x 79 mm max. 102 x 52 x 79 mm min. 1 3/4 x 2 1/16 x 3 1/8 in max. 4 x 2 1/16 x 3 1/8 in |
| Mounting position | any |



NOTE

Further technical information, technical drawings, accessories, spare parts or product function descriptions available on SKF.com/lubrication.

Metering device

SL-32

Order information

| Order number | Designation | Outlets | Material | Inlet | Outlet | Dimensions fixing holes | | length, total | |
|----------------|--------------------------------|---------|-----------------|--------------|--------|-------------------------|-------|---------------|-------|
| | | | | | | O.D. tubing | mm | in | mm |
| 83338 | SL-32 single, no manifold | 1 | carbon steel | 1/4 NPTF (M) | 1/8 | 32 | 1 1/4 | 44 | 1 3/4 |
| 83336-1 | SL-32 incl. manifold | 1 | carbon steel | 1/4 NPTF (F) | 1/8 | 51 | 2 | 63 | 2 1/2 |
| 83336-2 | SL-32 incl. manifold | 2 | carbon steel | 1/4 NPTF (F) | 1/8 | 70 | 2 3/4 | 83 | 3 1/4 |
| 83336-3 | SL-32 incl. manifold | 3 | carbon steel | 1/4 NPTF (F) | 1/8 | 89 | 3 1/2 | 102 | 4 |
| 83336-4 | SL-32 incl. manifold | 4 | carbon steel | 1/4 NPTF (F) | 1/8 | – | – | – | – |
| 83337 | SL-32 replacement, no manifold | 1 | carbon steel | – | 1/8 | – | – | – | – |
| 83724-1 | SL-32 incl. manifold | 1 | stainless steel | 1/4 NPTF (F) | 1/8 | 32 | 1 1/4 | 44 | 1 3/4 |
| 83724-2 | SL-32 incl. manifold | 2 | stainless steel | 1/4 NPTF (F) | 1/8 | 51 | 2 | 63 | 2 1/2 |
| 83724-3 | SL-32 incl. manifold | 3 | stainless steel | 1/4 NPTF (F) | 1/8 | 70 | 2 3/4 | 83 | 3 1/4 |
| 83724-4 | SL-32 incl. manifold | 4 | stainless steel | 1/4 NPTF (F) | 1/8 | 89 | 3 1/2 | 102 | 4 |
| 83337-9 | SL-32 replacement, no manifold | 1 | stainless steel | – | 1/8 | – | – | – | – |

1. Injectors, except replacement injectors for manifold, include compression nut and ferrule for tubing - * O.D. as standard. Other outlet connectors for feed line optional.
2. Injectors with manifolds include two mounting clips and screws.
3. Injectors have Nitrile packings (200°F max. / 93°C). Check packing compatibility with synthetic lubricants.
4. Output with indicator cap hand tightened is .001 cu. in. Maximum output is achieved with five turns at 0014 cu. in./turn.

SL-32, 4 outlets incl. manifold (83336-4)



SL-32 replacement without manifold (83337)



Metering device

SL-32HV

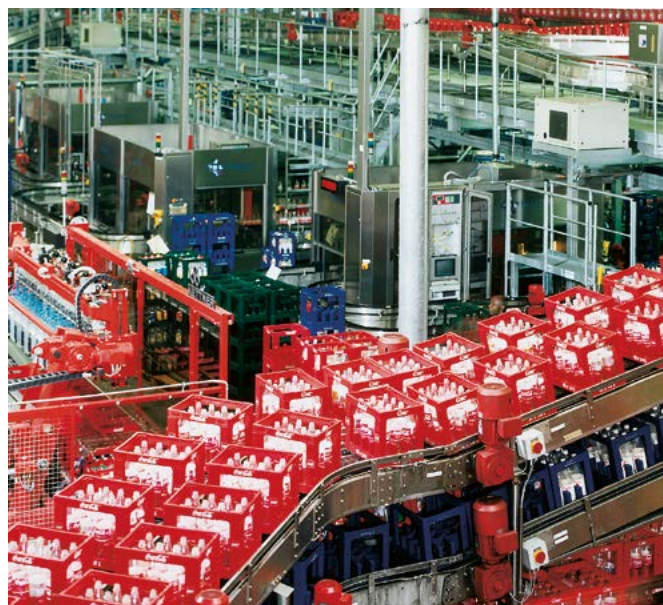

Description

The series SL-32HV (high venting) metering devices are for single-line, high-pressure centralized lubrication systems dispensing petroleum-based lubricants with a viscosity up to NLGI 2 (refer to Design Guide). Output is externally adjustable. The indicator stem permits visual check of metering device operation. Individual metering devices can be removed easily for inspection or replacement.

Features and benefits

- Shipped with manifolds from 1 to 10 ports to match number of lube points
- Output is externally adjustable
- Indicator stem permits visual check of operation
- Can be removed easily for inspection or replacement
- Available in stainless steel SAE 304

Applications

- Food and beverage, industrial automation
- Machine tools, oil and gas
- Steel industry, pulp and paper
- Marine and forestry, construction
- Wind energy, mobile on-road



NOTE

Further technical information, technical drawings, accessories, spare parts or product function descriptions available on SKF.com/lubrication.

Technical data

| | |
|-----------------------|---|
| Function principle | metering device |
| Outlets | 1 to 10 |
| Metering quantity | 0,016 to 0,131 cm ³ 0,001 to 0,008 in ³ |
| Lubricant | grease NLGI 0, 1, 2 |
| Operating temperature | max. +93 °C; +200 °F |
| Operating pressure | 83 to 240 bar, 1 200 to 3 500 psi |
| Relief pressure | 28 bar, 400 psi |
| Material | carbon steel, nitrile packings |
| Connection main line | 1/4 NPTF (F), 1/4 NPTF (M) |
| Connection outlet | 1/8 in O.D. tube |
| Lubricant point | solderless pipe connection (DIN 3862) |
| Dimensions | min. 44,5 × 93 × 52 mm max. 215 × 93 × 52 mm min. 1.8 × 3.6 × 2.1 in max. 8.5 × 3.6 × 2.1 in |
| Mounting position | any |

Order information

| Order number | Designation | Outlet |
|--------------|--------------------------------------|--------|
| 83336HV-1 | metering device | 1 |
| 83336HV-2 | metering device | 2 |
| 83336HV-3 | metering device | 3 |
| 83336HV-4 | metering device | 4 |
| 83336HV-5 | metering device | 5 |
| 83336HV-6 | metering device | 6 |
| 83336HV-7 | metering device | 7 |
| 83336HV-8 | metering device | 8 |
| 83336HV-9 | metering device | 9 |
| 83336HV-10 | metering device | 10 |
| 83338HV | metering device, single, no manifold | 1 |
| 83337HV | metering device, single replacement | – |

Metering device

SL-1



Description

The series SL-1 metering devices are for single-line, high-pressure centralized lubrication systems dispensing lubricants compatible with fluoroelastomer packings and viscosity up to NLGI 2. Output is externally adjustable. An indicator stem permits visual check of metering device operation. Individual metering devices can be removed easily for inspection or replacement. Available in stainless steel SAE 316, for applications where environmental conditions are hazardous to carbon steel or in industries preferring stainless steel.

Features and benefits

- Shipped with manifolds from 1 to 6 ports (lubrication points)
- Output is externally adjustable
- Each indicator stem permits visual check of injector operation
- Individual metering devices can be removed easily for inspection or replacement
- Includes fitting for feed lines via alternate outlet port
- Available in stainless steel SAE 316

Applications

- Mining and mineral processing
- Construction machinery, steel/heavy industry



NOTE

Further technical information, technical drawings, accessories, spare parts or product function descriptions available on SKF.com/lubrication.

Technical data

| | |
|-----------------------|---|
| Function principle | metering device |
| Outlets | 1 to 6 |
| Metering quantity | 0,131 to 1,31 cm ³ 0,008 to 0,080 in ³ |
| Lubricant | grease NLGI 0, 1, 2 |
| Operating temperature | -26 to +176 °C; -15 to +350 °F |
| Operating pressure | 127 to 240 bar, 1 850 to 3 500 psi |
| Relief pressure | 41 bar, 600 psi |
| Material | carbon steel, stainless steel 316 |
| Connection main line | 3/8 NPTF (F) |
| Connection outlet | 1/8 NPTF (F) |
| Lubricant point | solderless pipe connection |
| Dimensions | min. 63 × 179,4 × 52,4 mm max. 203 × 179,4 × 52,4 mm min. 2.5 × 7.0 × 2.0 in max. 8.0 × 7.0 × 2.0 in |
| Mounting position | any |

Order information

| Order number | Designation | Outlet |
|--------------|-----------------|--------|
| 81770-1 | metering device | 1 |
| 81770-2 | metering device | 2 |
| 81770-3 | metering device | 3 |
| 81770-4 | metering device | 4 |
| 81770-5 | metering device | 5 |
| 81770-6 | metering device | 6 |

Metering device

QSL



Description

QSL metering devices are designed for 300 bar pressure. As a result, NLGI 2 greases can be pumped at temperatures below zero without problems. All metering devices operate independently of each other. This means that in the event of a blockage or fault of one metering device, all other metering devices will continue to supply lubricant. A control pin on top shows proper function of each metering device.

Features and benefits

- Suitable for use with manifolds from 1 to 6 ports to match number of lube points; must be ordered separately
- Corrosion-resistant, black-chromated or nickel-plated surface
- Each indicator stem permits visual check of operation
- Can be removed easily for inspection or replacement
- Controlled via main line

Applications

- Renewable energy
- Construction machinery
- Mining and mineral processing
- Compact and medium-sized machines and industrial applications
- Commercial vehicles

Technical data

| | |
|-----------------------|--|
| Function principle | metering device |
| Outlets | 1 to 6 |
| Metering quantity | 0,05 to 0,4 cm ³ , 0.003 to 0.024 in ³ |
| Lubricant | grease NLGI 0, 1, 2 |
| Operating temperature | -40 to +70 °C; -40 to +158 °F |
| Operating pressure | 140 to 300 bar, 2 030 to 4 350 psi |
| Relief pressure | ≤ 60 bar, ≤ 870 psi |
| Materials | steel, black chromated, polyurethane |
| Connection main line | G 3/8 for steel pipe 16 × 2 mm; 0.63 × 0.08 in |
| Connection outlet | G 1/8 for tubes/hoses 4,1 × 2,3 mm; 0.16 × 0.09 in |
| Lubricant point | solderless pipe connection, DIN 3862 or SKF quick connector |
| Dimensions | length: max. 160 mm, 6.3 in Ø 28 mm; 1.1 in |
| Mounting position | any |



NOTE

Further technical information, technical drawings, accessories, spare parts or product function descriptions available on SKF.com/lubrication:

12735 EN

Metering device

QSL

QSL order numbers

| Order number ¹⁾ | Designation Injectors | Metering quantity per stroke | | Ring color |
|----------------------------|-----------------------|------------------------------|-----------------|------------|
| | | cm ³ | in ³ | |
| 554-32810-1 | QSL 0,05 | 0,05 | 0.00305 | blue |
| 554-32811-1 | QSL 0,1 | 0,10 | 0.00610 | white |
| 554-32812-1 | QSL 0,2 | 0,20 | 0.01220 | yellow |
| 554-32813-1 | QSL 0,3 | 0,30 | 0.01830 | red |
| 554-32814-1 | QSL 0,4 | 0,40 | 0.02440 | green |

¹⁾ In the case of backpressures in lubrication point lines of ≥ 100 bar or if several injectors are combined to one lubrication point, use check valves, order number 223-12289-7.

Accessory

Manifold, check valves and closure kit



Description

For QLS metering devices, manifolds utilized are for 1 to 6 push-in points tightened by a hollow screw with thread G 3/8 for O-ring sealing. Normal profile design manifolds are available in steel. The main line connection G 3/8 is for steel pipe 16 x 2 mm (0.63 x 0.08 in). The lubrication connection is for plastic tube 4,1 x 2,3 mm (0.16 x 0.09 in).

Manifolds¹⁾

| Order number | Designation | Dimensions fixing hole | | length, total | |
|--------------|---------------------|------------------------|------|---------------|-------|
| | | mm | in | mm | in |
| 454-71505-1 | divider bar, 2-fold | 74 | 2.91 | 130 | 5.11 |
| 454-71506-1 | divider bar, 3-fold | 42 | 1.65 | 130 | 5.11 |
| 454-71507-1 | divider bar, 4-fold | 84 | 3.3 | 172 | 6.77 |
| 454-71508-1 | divider bar, 5-fold | 126 | 4.96 | 214 | 8.42 |
| 454-71509-1 | divider bar, 6-fold | 84 ¹⁾ | 3.3 | 256 | 10.07 |

¹⁾ Instead of the planned injectors a divider bar can also be equipped with a closure kit 5, order number: 554-34387-1

Check valves and closure kit

| Order number | Designation |
|--------------|--|
| 223-12289-7 | check valves for connection at lubrication point outlets |
| 554-34387-1 | closure kit 5 |

Metering device

VR



Description

Product series VR are 1- to 12-port prelubrication metering devices for single-line, centralized lubrication systems for fluid grease and grease up to NLGI 2. These metering devices are characterized by an innovative, compact and sturdy design with SKF Quick Connector systems.

Features and benefits

- Innovative, extremely compact design
- Optional metering devices for 1 to 12 ports to match number of lubrication points
- Metering nipples with indicator pin for visual monitoring of each lubrication point
- Optional push-in type or screw-in type fittings for feed line or main line connections are selectable
- Easy metering adjustment by replacing the metering nipples
- Black anodized surface for optimized corrosion protection
- Suitable for corrosivity category C3 and C5 per DIN EN ISO 12944 and certified by Germanischer Lloyd
- High functional reliability when using stiff greases at low working temperatures

Applications

- Onshore and offshore wind energy systems
- Construction machinery
- Steel industry
- Heavy industry
- General mechanical engineering applications



Technical data

| | |
|-----------------------|--|
| Function principle | block metering device |
| Outlets | 1 to 12 |
| Metering quantity | non-adjustable: 0,1 to 1,3 cm ³ /min 0.006 to 0.079 in ³ /min adjustable: 0,1 to 1,1 cm ³ /min 0.006 to 0.067 in ³ /min |
| Lubricant | fluid greases and grease NLGI 0, 1, 2 |
| Operating temperature | -25 to +80 °C; -13 to +176 °F |
| Operating pressure | 100 to 315 bar; 1 450 to 4 570 psi |
| Relief pressure | 30 or 70 bar; 435 or 1 015 psi |
| Materials | anodized aluminum, stainless steel, FKM (FPM) |
| Connection main line | G 1/4 for pipes 4 or 6 mm 0.16 or 0.24 in |
| Connection outlet | G 1/8 for pipes 4 or 6 mm, 0.16 or 0.24 in |
| Lubricant point | solderless pipe connection (DIN 3862) |
| Dimensions | depending on model: min. 97 × 130 × 54 mm; max. 281 × 121 × 119 mm; min. 3.82 × 5.12 × 2.13 in max. 11.06 × 4.76 × 4.68 in |
| Mounting position | any |



NOTE

Further technical information, technical drawings, accessories, spare parts or product function descriptions available on SKF.com/lubrication:

1-5001-EN, 951-230-007



3D

skf-lubrication.partcommunity.com/3d-cad-models

Metering device

VR

Identification code

V R

Product series

Number of metering points

| | |
|--------|---------|
| 01 = 1 | 07 = 7 |
| 02 = 2 | 08 = 8 |
| 03 = 3 | 09 = 9 |
| 04 = 4 | 10 = 10 |
| 05 = 5 | 11 = 11 |
| 06 = 6 | 12 = 12 |

1 2 3 4 5 6 7 8 9 10 11 12

Design for fluid grease and grease

| Design code | A | B | C | D | E | F | G | H | N | P |
|------------------------------------|-------|-------|----|----|----|----|-------|-------|-------------------|-------------------|
| Max. relief pressure [bar] | 30 | 70 | 30 | 70 | 30 | 70 | 30 | 70 | 30 | 70 |
| Secondary line connection | G 1/8 | G 1/8 | VS | VS | VS | VS | G 1/8 | G 1/8 | SRV ¹⁾ | SRV ¹⁾ |
| Secondary line Ø [mm] | – | – | 4 | 4 | 6 | 6 | – | – | 6 | 6 |
| Corrosivity category ²⁾ | C3 | C3 | C3 | C3 | C3 | C3 | C5-M | C5-M | C5-M | C5-M |

¹⁾ SRV = cutting-sleeve screw union, see page 2
²⁾ Corrosivity categories per DIN EN ISO 12944 (certified by Germanischer Lloyd)

Metering

| Metering quantity letter | A ¹⁾ | B ¹⁾ | D ¹⁾ | F ¹⁾ | H ¹⁾ | J ¹⁾ | M ¹⁾ | R ²⁾ | X |
|-----------------------------|-----------------|-----------------|-----------------|-----------------|-----------------|-----------------|-----------------|-----------------|--------|
| Metering [cm ³] | 0,1 | 0,2 | 0,4 | 0,6 | 0,8 | 1 | 1,3 | 0,1–1,1 | Closed |

¹⁾ Fixed metering with indicator pin for visual function monitoring
²⁾ Adjustable metering with indicator pin for visual function monitoring

Code letter
 Metering quantity letter (0 = not present, e.g. for VR06 assign 0 for metering points 7–12)
 Code for fittings for main line connection

Order example

VR06FFFFFFF000000Z

- Single-line distributor, 6-port
- Relief pressure max. 70 bar
- Lubrication point line connection using SKF plug connector for pipe Ø 6 mm
- Metering quantity 1–6 = 0,6 cm
- Without fitting for main line connection (G 1/4 thread)

Fittings for main line connection

| Left fitting | Right fitting | Ø Main line [mm] | Code |
|------------------------------|------------------------------|------------------|----------------------|
| Cutting-sleeve screw union * | Cutting-sleeve screw union * | 8 10 | A G |
| Cutting-sleeve screw union * | Closed | 8 10 | B H |
| Closed | Cutting-sleeve screw union | 8 10 | C J |
| E0-2 screw union | E0-2 screw union | 8 10 | D K |
| E0-2 screw union | Closed | 8 10 | E L |
| Closed | E0-2 screw union | 8 10 | F M |
| G1/4 | G1/4 | – | Z |

Metering device

SLC



Description

The SKF Lincoln SLC metering device is designed for use in high-pressure singleline lubrication systems and features a modular design. Also, delivery volume can be adjusted via metering screws to ensure each lubrication point receives the required amount of lubricant. Featuring a spring-reset control piston, the metering device has a high venting capability compatible with greases up to NLGI 2. The SLC offers easy configuration to meet your needs, including different output quantity, fitting and adjustment options. With the most compact construction in its class, the SLC is suitable for many applications in renewable energy, construction, mining as well as in heavy industry.

Features and benefits

- High venting capability
- Wide delivery volume range
- Compact construction
- Easy to monitor and maintain
- Simplified failure analysis
- Reduced risk of leaks
- Reliable operation in harsh conditions with a wide operating temperature range
- Patented design and functionality
- Easy to clean

Applications

- Renewable energy
- Construction and mining
- Heavy industry

Technical data

| | |
|----------------------------|--|
| Function principle | block metering device |
| Outlets | SLC1: 1 to 12 SLC2: 1 to 6 |
| Metering quantity | optionally adjustable or fixed SLC1: 0.1–0.7 cm ³ /stroke; 0.006–0.042 in ³ /stroke SLC2: 0.2–1.4 cm ³ /stroke; 0.012–0.084 in ³ /stroke |
| Lubricant | grease up to NLGI 2 |
| Operating temperature | –40 to +100 °C; –40 to +212 °F |
| Operating pressure | 150 to 315 bar; 2 175 to 4 570 psi |
| Relief pressure | 68 bar; 990 psi |
| Materials | steel |
| Corrosion protection class | C3-High, C4-Medium (DIN EN ISO 12944) |
| Dimensions | SLC1: min. 75 × 50 × 80 mm max. 215 × 50 × 180 mm min. 2.95 × 1.97 × 3.15 in max. 8.46 × 1.97 × 7.08 in SLC2: min. 75 × 40 × 80 mm max. 215 × 40 × 205 mm min. 2.95 × 1.57 × 3.15 in max. 8.46 × 1.57 × 8.07 in |
| Mounting position | any, preferably vertical |



NOTE

Further technical information, technical drawings, accessories, spare parts or product function descriptions available on SKF.com/lubrication:

17717EN



3D

skf-lubrication.partcommunity.com/3d-cad-models

Metering device

SLC

Identification code S L C [] [] 3 - [] [] [] [] [] [] - [] [] []

Product series S L C

Doser size
 1 = SLC1 (1–2 outlets per section)
 2 = SLC2 (1 outlet per section)

Main line connections
 G = BSP thread for metric tubing
 A = NPTF thread for imperial tubing

Corrosion protection class
 3 = C3-H, C4-M

Layout variants
 A = Top: stroke adjustment
 B = Top: stroke adjustment, bottom: visual memory indicator
 C = Top: stroke adjustment, bottom: electrical performance detector
 D = Bottom: stroke adjustment
 E = Top: electrical performance detector, bottom: stroke adjustment

Metering quantity

| | | |
|--|--|--|
| <p>SLC1 single outlet/section version: 1 = 0,2 cm³/stroke; 0,012 in³/stroke 2 = 0,3 cm³/stroke; 0,018 in³/stroke 3 = 0,4 cm³/stroke; 0,024 in³/stroke 4 = 0,5 cm³/stroke; 0,030 in³/stroke 5 = 0,6 cm³/stroke; 0,036 in³/stroke 6 = 0,8 cm³/stroke; 0,048 in³/stroke 7 = 1,0 cm³/stroke; 0,060 in³/stroke 8 = 1,2 cm³/stroke; 0,072 in³/stroke 9 = 1,4 cm³/stroke; 0,084 in³/stroke S = adjustable 0,2–1,4 cm³/stroke; 0,012–0,084 in³/stroke V = reserve outlet, closed Z = adjustable, reserve outlet, closed X = no metering section</p> | <p>SLC1 twin outlet/section version: B = 0,1 cm³/stroke; 0,006 in³/stroke C = 0,15 cm³/stroke; 0,009 in³/stroke D = 0,2 cm³/stroke; 0,012 in³/stroke E = 0,25 cm³/stroke; 0,015 in³/stroke F = 0,3 cm³/stroke; 0,018 in³/stroke G = 0,4 cm³/stroke; 0,024 in³/stroke H = 0,5 cm³/stroke; 0,030 in³/stroke K = 0,6 cm³/stroke; 0,036 in³/stroke L = 0,7 cm³/stroke; 0,042 in³/stroke R = adjustable 0,1–0,7 cm³/stroke; 0,006–0,042 in³/stroke X = no metering section</p> | <p>SLC2 single outlet/section version: 1 = 0,2 cm³/stroke; 0,012 in³/stroke 2 = 0,3 cm³/stroke; 0,018 in³/stroke 3 = 0,4 cm³/stroke; 0,024 in³/stroke 4 = 0,5 cm³/stroke; 0,030 in³/stroke 5 = 0,6 cm³/stroke; 0,036 in³/stroke 6 = 0,8 cm³/stroke; 0,048 in³/stroke 7 = 1,0 cm³/stroke; 0,060 in³/stroke 8 = 1,2 cm³/stroke; 0,072 in³/stroke 9 = 1,4 cm³/stroke; 0,084 in³/stroke S = adjustable 0,2–1,4 cm³/stroke; 0,012–0,084 in³/stroke V = reserve outlet, closed Z = adjustable, reserve outlet, closed X = no metering section</p> |
|--|--|--|

Lubricant inlet connections, main line

| | |
|---|---|
| <p>X = no fitting A = Ø8 mm tube straight fitting, ferrule and nut B = Ø8 mm tube straight fitting, E02 seal C = Ø8 mm tube straight fitting without ferrule and nut D = Ø10 mm tube straight fitting, ferrule and nut E = Ø10 mm tube straight fitting, E02 seal F = Ø10 mm tube straight fitting without ferrule and nut G = Ø12 mm tube straight fitting, ferrule and nut H = Ø12 mm tube straight fitting, E02 seal I = Ø12 mm tube straight fitting without ferrule and nut K = Ø10 mm tube banjo fitting, ferrule and nut L = Ø10 mm tube banjo fitting without ferrule and nut M = Ø12 mm tube banjo fitting, ferrule and nut N = Ø12 mm tube banjo fitting without ferrule and nut</p> | <p>O = Ø8 mm tube adjustable elbow fitting, ferrule and nut P = Ø8 mm tube adjustable elbow fitting, E02 seal R = Ø8 mm tube adjustable elbow fitting without ferrule and nut S = Ø10 mm tube adjustable elbow fitting, ferrule and nut T = Ø10 mm tube adjustable elbow fitting, E02 seal U = Ø10 mm tube adjustable elbow fitting without ferrule and nut V = Ø12 mm tube adjustable elbow fitting, ferrule and nut W = Ø12 mm tube adjustable elbow fitting, E02 seal Y = Ø12 mm tube adjustable elbow fitting without ferrule and nut Z = closure plug</p> |
|---|---|

Lubricant outlet connections, feed line

| | | | |
|---|---|---|--|
| <p>SLC1G: X = no fitting A = Ø6 mm tube plug in fitting R = Ø1/4 tube plug in fitting</p> | <p>SLC1A: X = no fitting R = Ø1/4 tube plug in fitting</p> | <p>SLC2G: X = no fitting A = Ø6 mm tube plug in fitting E = Ø8 mm tube plug in fitting I = Ø10 mm tube plug in fitting</p> | <p>SLC2A: X = no fitting</p> |
|---|---|---|--|

Metering device

SL-11



Description

Series SL-11 metering devices are for single-line, high-pressure centralized lubrication systems dispensing lubricants compatible with fluoroelastomer packings and viscosity up to NLGI 2. Output is externally adjustable. An indicator stem permits visual check of metering device operation. Available only as single unit with 1/2 inch NPTF (F) inlet.

Features and benefits

- Output is externally adjustable
- Indicator stem permits visual check of injector operation
- May be combined in a circuit of metering devices SL-32, SL-33, SL-VXL, SL-V and/or SL-1
- Can be removed easily for inspection or replacement
- Includes fitting for filling feed lines via alternate outlet port

Applications

- Construction machinery
- Mining and mineral processing
- Steel industry
- Heavy industry

Technical data

| | |
|-----------------------|---|
| Order number | 85497 |
| Function principle | metering device |
| Outlets | 1 |
| Metering quantity | 0,82 to 8,2 cm ³ 0,050 to 0,500 in ³ |
| Lubricant | grease NLGI 0, 1, 2 |
| Operating temperature | -40 to +93 °C; -40 to +200 °F |
| Operating pressure | 70 to 240 bar, 1 000 to 3 500 psi |
| Relief pressure | 55 bar, 800 psi |
| Materials | carbon steel, FKM, PTFE |
| Connection main line | 1/2 NPTF (F) |
| Connection outlet | 1/4 NPTF (F) |
| Lubricant point | solderless pipe connection (DIN 3862) or plug connector |
| Dimensions | 73 × 241 mm 2,87 × 9,48 in |
| Mounting position | any |

Metering devices have fluoroelastomer packings. Check packing compatibility with synthetic lubricants; metering devices supplied with fitting for filling feed line via alternate outlet port. Output with adjustment screw hand-tightened is 0,82 cm³ (0,05 in³); maximum output is achieved with 11 1/2 turns at 0,66 cm³/turn (0,04 in³/turn).



NOTE

Further technical information, technical drawings, accessories, spare parts or product function descriptions available on SKF.com/lubrication.

Metering device

SL-V

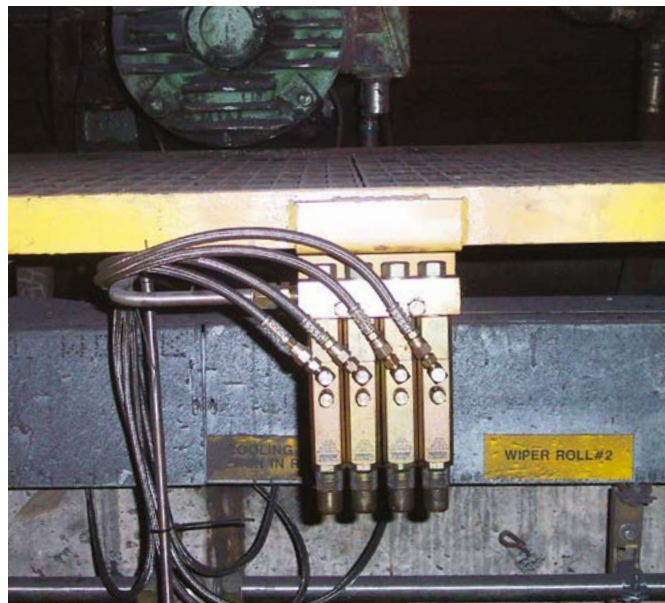

Description

Series SL-V metering devices are for single-line, high-pressure centralized lubrication systems dispensing lubricants compatible with polyurethane seals up to NLGI 2. Output is externally adjustable. An indicator stem permits visual check of metering device operation. Individual metering devices can be removed easily for inspection or replacement. Each SL-V metering device includes a clear, polycarbonate protective cap.

Features and benefits

- Shipped with manifolds from 1 to 6 ports
- Output is externally adjustable
- Clear, polycarbonate protected cap over indicator stem permits visual check of operation
- Can be removed easily for inspection or replacement
- Output setting system by a set of color-coded sleeves

Applications

- Construction machinery
- Mining and mineral processing
- Steel industry



NOTE

Further technical information, technical drawings, accessories, spare parts or product function descriptions available on SKF.com/lubrication.

Technical data

| | |
|-----------------------|---|
| Function principle | metering device |
| Outlets | 1 to 6 |
| Metering quantity | 0,25 to 1,31 cm ³ 0.015 to 0.08 in ³ |
| Lubricant | grease NLGI 0, 1, 2 |
| Operating temperature | max. +82 °C; +180 °F |
| Operating pressure | 128 to 413 bar, 1 850 to 6 000 psi typical: 172 bar, 2 500 psi |
| Relief pressure | 70 bar, 1 000 psi |
| Materials | carbon steel |
| Connection main line | 3/8 NPTF (F) |
| Connection outlet | 1/8 NPTF (F) |
| Dimensions | min. 63 × 222 × 35 mm max. 203 × 222 × 35 mm min. 2.5 × 8.7 × 1.4 in max. 6.1 × 8.7 × 1.4 in |
| Mounting position | any |

Metering device manifolds have 10,3 mm (0.4 in) dia. mounting holes for 9,5 mm (0.375 in) bolt; metering devices have polyurethane seals; check compatibility with synthetic lubricants; metering devices include fitting for filling feedlines via alternate outlet port; output with adjustment screw hand-tightened is 0,246 cm³ (0.015 in³); maximum output is achieved with five turns at 0,229 cm³/turn (0.014 in³/turn).

Order information

| Order number | Outlets | Designation |
|--------------|---------|--|
| 85770-1 | 1 | Metering device incl. manifold |
| 85770-2 | 2 | Metering device incl. manifold |
| 85770-3 | 3 | Metering device incl. manifold |
| 85770-4 | 4 | Metering device incl. manifold |
| 85770-5 | 5 | Metering device incl. manifold |
| 85770-6 | 6 | Metering device incl. manifold |
| 85771 | 1 | Replacement metering device for manifold |
| 85772 | 1 | Single metering device, no manifold inlet 3/8 NPTF (M) |

Metering device

SL-V XL



Description

Series SL-VXL high-output metering devices are for single-line, high-pressure centralized lubrication systems dispensing lubricants compatible with polyurethane seals up to NLGI 2. Output is externally adjustable. An indicator stem permits visual check of metering device operation. Individual metering devices can be removed easily for inspection or replacement. Two SL-VXL metering devices are required to replace one SL-11 metering device. Each SL-VXL metering device includes a clear, polycarbonate protective cap.

Features and benefits

- Suitable for use with manifolds from 1 to 6 ports to match number of lubrication points
- Output is externally adjustable
- Includes a clear, polycarbonate protective cap over indicator stem that permits visual check of operation
- Can be removed easily for inspection or replacement
- Includes fitting for filling feed lines via alternate outlet port

Applications

- Construction machinery
- Mining and mineral processing
- Heavy industry

Technical data

| | |
|-----------------------|---|
| Function principle | metering device |
| Outlets | 1 to 6 |
| Metering quantity | 0,25 to 5,00 cm ³ , 0.015 to 0.305 in ³ |
| Lubricant | grease NLGI 0, 1, 2 |
| Operating temperature | -40 to +82 °C; -40 to +180 °F |
| Operating pressure | 128 to 413 bar; 1 850 to 6 000 psi |
| Relief pressure | 70 bar; 1 000 psi |
| Materials | carbon steel |
| Connection main line | 3/8 NPTF (F) |
| Connection outlet | 1/8 NPTF (F) |
| Lubricant point | solderless pipe connection (DIN 3862) or plug connector |
| Dimensions | min. 63 × 284 × 35 mm max. 203 × 284 × 35 mm min. 2.5 × 11.2 × 1.4 in max. 6.1 × 11.2 × 1.4 in |
| Mounting position | any |

Metering device manifolds have 10,3 mm (0.4 in) dia. mounting holes for 9,5 mm (0.375 in) bolt; metering devices have polyurethane seals. Check compatibility with synthetic lubricants; metering devices include fitting for filling feed lines via alternate outlet port; output with adjustment screw hand-tightened is 0,246 cm³ (0.015 in³); maximum output is achieved with 20.5 turns at 0,229 cm³/turn (0.014 in³/turn).



NOTE

Further technical information, technical drawings, accessories, spare parts or product function descriptions available on SKF.com/lubrication.

Metering device

SL-V XL

Identification code

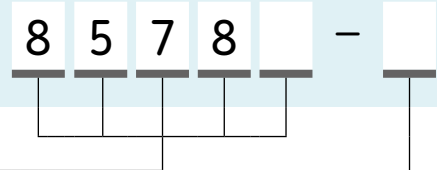

Product series, carbon steel

- 85780 = metering device incl. manifold, 3/8 NPTF (M) inlet
- 85781 = replacement for manifold metering device (only one outlet possible)
- 85782 = single metering device, no manifold, 3/8 NPTF (M) inlet (only one outlet possible)

Outlets

- 1 = 1
- 2 = 2
- 3 = 3
- 4 = 4
- 5 = 5
- 6 = 6



Overview of control units

| Control units | | | | | | | |
|---------------|-----------------------|-------------|---------------------|---------|------------|------------------|------|
| Product | Operating temperature | | Supply voltage max. | | Adjustable | Level monitoring | Page |
| | °C | °F | VDC | VAC | | | |
| EXZT2A02 | 0 to 60 | +32 to 140 | 12/24 | 120 | • | – | 146 |
| EXZT2A05 | 0 to 60 | +32 to 140 | 12/24 | 120 | • | • | 146 |
| EXZT2A07 | 0 to 60 | +32 to 140 | 12/24 | 120 | • | • | 146 |
| IGZ36-20 | 0 to 60 | +32 to 140 | 12/24 | 120 | • | – | 146 |
| IGZ36-20-S6 | 0 to 60 | +32 to 140 | 12/24 | 120 | • | • | 146 |
| IGZ38-30 | 0 to 60 | +32 to 140 | 12/24 | 120 | – | • | 146 |
| IGZ38-30-S1 | 0 to 60 | +32 to 140 | 12/24 | 120 | – | • | 146 |
| IGZ51-20-S3 | 0 to 60 | +32 to 140 | 12/24 | 120 | – | – | 146 |
| ST-2240-LUB | 0 to 50 | +32 to 140 | – | 132/264 | • | • | 148 |
| ST-1240 | 0 to 50 | +32 to 140 | – | 132/264 | • | • | 150 |
| ST-102 | -40 to +80 | -40 to +176 | 12/24 | – | • | • | 151 |
| ST-102P | -40 to +80 | -40 to +176 | 12/24 | – | • | • | 152 |
| 84501 | -18 to +54 | 0 to +130 | – | 120/230 | • | – | 153 |
| LMC 101 | -40 to +65 | -40 to +150 | 12/24 | – | • | • | 154 |
| EOT-1 | -25 to +70 | -13 to +158 | 12/24 | – | • | • | 157 |
| EOT-2 | -25 to +70 | -13 to +158 | 12/24 | – | • | • | 157 |
| 85307 | -15 to +50 | +5 to 122 | 12/24 | – | • | • | 156 |
| IG502-2-E | -25 to +75 | -13 to +167 | 12/24 | – | • | • | 157 |
| LMC 2 | -10 to +70 | +14 to 158 | 12/24 | 230 | • | • | 158 |
| LMC 301 | -40 to +70 | -40 to +158 | 24 | 90–264 | • | • | 160 |

Control unit

EXZT/IGZ



Description

Universal electronic control and monitoring devices are used in single-line and progressive lubrication systems for stationary industrial applications, installed in a switching cabinet or internally in a compact lubrication unit. Two different versions are required: +471 for 100 to 120 VAC and 200 to 240 VAC; and +472 for 24 VDC and 24 VAC. The universal devices can be used as time-dependent or pulse-dependent controllers. The main task is to initiate a lubrication cycle after a set time. The devices also monitor the piston strokes and run the pump during the lubrication time in clogged operation. All devices have custom-built functions integrated and can be configured to meet the requirements of the application. Mentioned device models must be selected based on their special function configuration and additional features according to the user manual.

Features and benefits

- Easy installation via top hat rail mounting
- One unit for different operating modes such as timer, counter and monitoring functions; other features are adjustable
- Pulse generator/counter with adjustable interval time
- Time operation or machine clogged operation
- Pump run time limitation
- Monitoring of pressure build-up, contact (NO)
- Low-level control and EEPROM as an additional feature

Applications

- All single-line lubrication systems for stationary industrial applications

Technical data

| | |
|-----------------------|--|
| Function principle | universal electronic control and monitoring device |
| Operating temperature | 0 to 60 °C; +32 to 140 °F |
| Output voltage | 24 VDC +10% / -15% |
| Connector for class | II |
| Protection class | IP 30, clamps IP 20 |
| Dimensions | 70 × 75 × 110 mm 2.7 × 3 × 4.3 in |

Version + 471

| | |
|-----------------------|------------------------------|
| Input voltage | 100 – 120 VAC; 200 – 240 VAC |
| Input current rated | 70 mA / 35 mA |
| Power input | 8 W |
| Frequency | 50 – 60 Hz |
| Fuse | max. 6.3 A |
| Switching current | max. 5 A |
| Input voltage sensors | 24 VDC |

Version + 472

| | |
|-----------------------|---------------------------------|
| Input voltage | 20 to 24 VDC; 20 to 24 VAC |
| Input current rated | 75 mA at max. fan-out of 250 mA |
| Power input | 5 W |
| Frequency | DC or 50 – 60 Hz |
| Fuse | max. 6.3 A |
| Switching current | max. 5 A |
| Input voltage sensors | 24 VDC |



NOTE

Further technical information, technical drawings, accessories, spare parts or product function descriptions available on SKF.com/lubrication:

1-1700-4-EN, 951-180-001

Control unit

EXZT/IGZ

Order information

| Order number | Input voltage | Adjustable monitoring time | Adjustable pump delay time | Monitoring of pressure relief, contact | Lubricant level monitoring, contact | Interval time extension | Early lubricant level warning, contact | Pulse monitoring | Adjustable failure memor EEPROM |
|-------------------|---------------|----------------------------|----------------------------|--|-------------------------------------|-------------------------|--|------------------|---------------------------------|
| EXZT2A02-E+471 | 120 VAC | • | • | NO ¹⁾ | NO ¹⁾ | • | – | – | – |
| EXZT2A02-E+472 | 24 VDC | • | • | NO ¹⁾ | NO ¹⁾ | • | – | – | – |
| IGZ36-20-I+471 | 120 VAC | • | • | NC ²⁾ | NO ¹⁾ | – | – | – | – |
| IGZ36-20-I+472 | 24 VDC | • | • | NC ²⁾ | NO ¹⁾ | – | – | – | – |
| IGZ36-20-S6-I+471 | 120 VAC | • | • | NC ²⁾ | NC ²⁾ | – | – | – | – |
| IGZ36-20-S6-I+472 | 24 VDC | • | • | NC ²⁾ | NC ²⁾ | – | – | – | – |
| IGZ38-30-I+471 | 120 VAC | – | – | – | NC ²⁾ | – | – | – | – |
| IGZ38-30-I+472 | 24 VDC | – | – | – | NC ²⁾ | – | – | – | – |
| IGZ38-30-S1-I+471 | 120 VAC | – | – | – | NO ¹⁾ | – | – | – | – |
| IGZ38-30-S1-I+472 | 24 VDC | – | – | – | NO ¹⁾ | – | – | – | – |
| IGZ51-20-S3-I+471 | 120 VAC | • | • | NC ²⁾ | NO ¹⁾ | • | – | – | • |
| IGZ51-20-S3-I+472 | 24 VDC | • | • | NC ²⁾ | NO ¹⁾ | • | – | – | • |

¹⁾ NO = contact normally open
²⁾ NC = contact normally closed

Control unit

ST-2240-LUB



Description

SKF ST-2240-LUB is a multichannel lubrication control system for industrial grease and oil lubrication solutions. ST-2240-LUB supports many combinations of SKF single-line, dual-line and progressive lubrication systems. The system can be divided in up to 14 lubrication channels which can be controlled and monitored individually. The lubrication system can be expanded afterwards by installing new channel modules. The unit's touch interface is user-friendly and provides remote control via smartphone or Ethernet. This SKF control centre offers a modern, flexible and cost-effective solution for industrial grease and oil lubrication systems.

Features and benefits

- Modular unit that supports easy system modification
- Supports versatile and automatic pump change (Dualset)
- Compatible with ultrasonic low level sensor
- Grease spraying control with air monitoring
- Compatible with SKF doser monitor

Applications

- Steel industry
- Mining and cement industry
- Pulp and paper industry
- Food and beverage

Technical data

| | |
|--------------------------|---|
| Function principle | control center |
| Operating temperature | 0 to +50 °C, +32 to +122 °F |
| Lubricant channels | 1-14 |
| Supply voltage | 115/230 VAC, automatic range selection |
| Supply voltage frequency | 47 to 63 Hz |
| Control voltage | 24 V DC, ± 10 % |
| Overload protection | automatic fuse, 6 A |
| Cable connection | screw terminals for 2,5 mm ² wires |
| Protection class | IP 65 |
| Interface | 5.7" TFT touch screen , 320 × 240, 64k colors, ethernet and USB port mobile app for monitoring |
| Data logging | Log files on USB memory |
| Fieldbus | ModbusTCP slave, other protocols on request |
| Alarm Outputs | relays K1 & K2: potential-free change over contact; maximum load 230 V/1 A; channel modules: potential-free contact; maximum load 50 V DC/1A |
| Dimensions | |
| ST-2240-LUB-6 | 600 × 600 × 250 mm 23.6 × 23.6 × 9.8 in |
| ST-2240-LUB-14 | 600 × 1 000 × 250 mm 23.6 × 39.4 × 9.8 in |



NOTE

Further technical information, technical drawings, accessories, spare parts or product function descriptions available on SKF.com/lubrication:

PUB LS/P2 17950 EN

Control unit

ST-2240-LUB



Order information

| Order number | Designation |
|--------------|---|
| 12380760 | ST-2240-LUB-6 control center (6 separate lubrication channels) |
| 12380765 | ST-2240-LUB-14 control center (14 separate lubrication channels) |
| 12501270 | CM channel module |

Data logging

Log files of alarms are available in the user interface and as files in USB memory. Also log files of user's actions and interlocking are recorded. Historical information can be read from USB memory in .csv-format.

User interface

- 5,7" touch screen color display
- USB-port for log and trend memory
- Ethernet port for remote control

Remote control and monitoring

ST-2240-LUB includes Ethernet port and free web server for remote control and monitoring by web browser.

- An App for Android and iOS available for remote control via LAN or WiFi
- Remote Control gives the user the same functionality as the local display
- Files in the USB memory are accessible by web browser
- Fieldbus to customer's DCS system

Alarms

Common alarm and warning with relay contact. Separate alarms for each channel:

- Low level alarm
- L1 (/ L2) high pressure alarm
- L1 (/ L2) low pressure alarm
- Pulse sensor alarm (progressive)
- Air alarm (grease spray)
- Doser monitor alarm
- Channel module fault

Channel modules

Each channel module can be equipped with:

Inputs:

- Pressure switch(es) or transmitter(s)
- Low level switch or transmitter
- Interlocking input signal
- External extra lubrication input signal or air monitoring

Outputs:

- Line valve(s)
- Shut-off valve
- Pump control
- Channel alarm, relay contact

Control unit

ST-1240



Description

ST-1240 is a control unit for automatic lubrication systems. While ST-1240-GRAPH is a two-channel lubrication control centre, ST-1240-GRAPH-4 supports up to four channels or zones. With ST-1240-GRAPH-RST a stainless steel version completes the range. All variants support any combination of single-line and progressive automatic lubrication systems (ALS). The lubrication channels can be zones, separated by shut-off valves or independent lubrication systems with separate pumping centres (max. 2) and varying lubricants. ST-1240 control centres come with a user-friendly colour touch screen panel that guides the user step-by-step through the application. The controllers support remote control via mobile devices or fieldbus, allowing easier system inspection and trouble shooting.

Features and benefits

- Reliable lubrication system control
- Control of up to 4 independently operating lubrication channels or lubrication systems
- Control of grease spraying systems incl. air pressure monitoring
- Control of low lubricant filling levels
- Control of system pressure deviations
- On-the fly lubricant barrel exchange (Dualset valve support)

Order information

| Order number | Designation | Material (cabinet) |
|--------------|-------------------|-------------------------|
| 12380210 | ST-1240 GRAPH | steel, painted RAL 7035 |
| 12380200 | ST-1240 GRAPH-4 | steel, painted RAL 7035 |
| 12380218 | ST-1240 GRAPH-RST | stainless steel |

Technical data

| | |
|-----------------------------------|---|
| Function principle | control center |
| Operating temperature | 0 to +50 °C, +32 to +122 °F |
| Lubrication channels | 2 and 4 (depending on model) |
| Supply voltage | 93 to 132 V AC, 186 to 264 V AC |
| Supply voltage frequency | 47 to 63 Hz |
| Supply current | 5,4 A/115 V AC, 2,2 A/230 V AC |
| Control voltage | 24 V DC, ± 10% |
| Overload protection | automatic fuse, 6 A |
| Cable connection | screw connections for 2,5 mm ² wires |
| Protection class | IP 65 |
| Interface | 5,7" touchscreen display, 320 × 240 pixel, 64k colors |
| API | RS-422 port for SKF online software |
| Terminal connections | Screw connections for 2,5 mm ² wires |
| Alarm outputs | Relay contact 1pcs (potential-free) |
| Interlock inputs | 2pcs (potential free contact) |
| Dimensions (without cable glands) | 380 × 300 × 210 mm |
| Weight | 14.9 × 11.8 × 8.3 in |
| | 10 kg |
| | 22 lbs |
| Mounting position | upright |

NOTE

Further technical information, technical drawings, accessories, spare parts or product function descriptions available on SKF.com/lubrication:

PUB LS/P8 12404 EN

Control unit

ST-102



Description

The ST-102 controller is designed for the control and monitoring of single-line, dual-line and progressive lubrication systems in vehicles with a 12 or 24 VDC power supply. It is a one-channel lubrication control centre for systems with pneumatic or electrical pumps. The ST-102 is suitable for environments with temperatures ranging from -30 to +80 °C (-22 to +176 °F) and features an IP 30 protection class. All lubrication configurations can be set in the field by the user.

Features and benefits

- Available for 12 or 24VDC
- Suitable for operational environments with extreme temperatures
- One-button user interface
- Power failure memory

Applications

- Service vehicles
- Construction machinery
- Agriculture machinery

Technical data

| | |
|--------------------------|--|
| Order number | 11500610 |
| Function principle | control and monitoring device |
| Operating temperature | -30 to +80 °C; -22 to +176 °F |
| Power supply | 12 and 24 VDC; (10,5 to 32 VDC) |
| Pump output control | max. 5 A |
| Protection class | IP 30 |
| Self-setting fuse | 4 A on pcb |
| Time, cycle settings: | |
| Max. pressurization time | 1 to 20 min |
| Interval time | 5, 10...120 min |
| Pressurization time | 1,2,3...10 min |
| Interface | 1-button user interface, 3 LED's |
| Input | 4 digital |
| Output | 4 digital |
| Standard | CE |
| Dimensions | 26 × 60 × 160 mm 1.02 × 2.36 × 6.3 in |
| Mounting position | vertical |



NOTE

Further technical information, technical drawings, accessories, spare parts or product function descriptions available on SKF.com/lubrication:

6408 EN

Control unit

ST-102P



Description

The ST-102P one-channel lubrication control centre is designed for the control and monitoring of lubrication systems in 12VDC or 24VDC vehicles. It supports single-line and dual-line lubrication systems. All lubrication configurations can be set in the field by the user. The ST-102P casing has an IP 65 rating.

Features and benefits

- Designed for control and monitoring in 12/24 VDC lubrication systems
- Reliable and durable, one-channel lubrication controller
- Supports single-line and dual-line lubrication systems
- All lubrication configurations can be set in the field by user
- IP 65 rating

Applications

- Control of lubrication systems with pneumatic pump SKF 40PGAS and electrical pump SKF Minilube
- Small excavators
- Wheel loaders,
- Trucks and buses

Technical data

| | |
|-----------------------|--|
| Order number | 11500608 |
| Function principle | control unit |
| Operating temperature | -40 to +80 °C -40 to +176 °F |
| Operating voltage | 12 or 24 VDC (10,5 to 32 VDC) |
| Pump output control | max. 5 A |
| Protection class | IP 65 |
| Self-setting fuse | 4 A on printed circuit board |
| Time, cycle settings: | |
| Pressurization time | 1 to 20 min |
| Interval time | 5, 10...120 min |
| Interface | 1-button user interface, 3 LEDs |
| Dimensions | 67 × 80 × 170 mm 2.64 × 3.14 × 6.7 in |
| Mounting position | vertical |

NOTE

Further technical information, technical drawings, accessories, spare parts or product function descriptions available on SKF.com/lubrication:

13165 EN

Control unit

84501



Description

Model 84501 program timer is used to control the lubrication cycle frequency of air-operated, single-stroke pumps. The timer turns pump on/off at programmed intervals via a 3-way or 4-way air solenoid valve (not included) installed in the air line to the pump. It is capable of retaining memory for three hours during machine shut down or power failure. Timing is suspended during power interruptions. This feature eliminates over-lubrication due to pre-lube when machine is frequently started and stopped. Using two programmable jumper pins, four options are available with the memory and prelube feature.

Features and benefits

- Program timer controls lubrication cycle frequency of air-operated, single-stroke pumps
- Timer turns pump on/off via solenoid air valves in programmed intervals
- Retains memory for three hours during machine shut down or power interruption
- Suspended timing during power interruptions eliminates over-lubrication due to pre-lube when machine is frequently started and stopped

Applications

- Cement industry
- Food and beverage
- Assembly lines
- Conveyors



Technical data

| | |
|-----------------------------|------------------------------------|
| Order number | 84501 |
| Function principle | control unit |
| Operating temperature | -18 to +54 °C; 0 to +130 °F |
| Operating voltage | 120/230 VAC |
| Operating voltage frequency | 50/60 Hz |
| Switch capacity | 120 VAC: 5 A 230 VAC: 1,5 A |
| Off-time cycle | min. 20 sec; max. 24 h |
| Off-time pumping | min. 10 sec; max. 1 min 24 sec |
| Prelube on time | 40 sec |
| Protection class | NEMA 1 |
| Standards | UL, CSA |
| Dimensions | 173 × 210 × 125 mm 7 × 8 × 5 in |
| Mounting position | vertical |



NOTE

Further technical information, technical drawings, accessories, spare parts or product function descriptions available on SKF.com/lubrication.

Control unit

LMC 101



Description

LMC 101 is a universal control and monitoring device for single-line and progressive lubrication systems. In single-line systems, pressure switches or pressure transducers can be installed at the pump and/or end of the supply line. While designed for off-the-road and mobile equipment use, the controller can be used for any low-voltage lubrication application. Timer or controller mode can be set for both systems. The device features various alarm condition settings, including cycle frequency or alarm triggers. Programming, data logging and reporting are possible, including system resets, downloads to controllers, lubrication activity, lubrication cycles and alarms. The controller must be programmed via USB connection to PC. In timer mode, the lubrication cycle ends when pre-assigned time has expired. In controller mode, the lubrication cycle ends when pressure switch, pressure transducer or piston detector actuates. System allows pressure to dissipate to end of supply line once pressure at pump is reached.

Features and benefits

- Various alarm condition settings including cycle frequency and alarm triggers
- Programming, data logging and reporting, including system resets, downloads to controllers, lubrication activity, lubrication cycles and alarms
- Display: LEDs, pump on and system fault (alarm)
- Controller must be programmed via USB connection to PC
- Manual lubrication push-button

Applications

- Off-highway vehicles
- Mobile equipment use

Technical data

| | |
|-----------------------|---|
| Function principle | control unit |
| Voltage input | 12 VDC and 24 VDC -20%/ +30% |
| Current consumption | 60 mA (less external load) |
| Vent relay contact | 20 A at 30 VDC |
| Pump relay contact | 2 A at 30 VDC |
| Alarm relay contact | 2 A at 30 VDC |
| Enclosure rating | NEMA 12 |
| Operating temperature | -40 to +65 °C; -40 to +150 °F |
| Net weight | 0,9 kg, 2 lbs |
| Off-time adjustable | 15 sec to 99 h |
| On-time adjustable | 15 sec to 99 h |
| Lubrication systems | single-line and progressive systems |
| Enclosure size | 209 × 127 × 89 mm 8,25 × 5 × 3,50 in |
| Mounting dimensions | 222 × 95 mm 8,75 × 3,75 in |

Order information

| Order number ¹⁾ | Designation |
|----------------------------|-------------|
|----------------------------|-------------|

| | |
|--------------------|-----------------------------|
| 86535 | LMC 101 controller |
| 236-10980-2 | motor starter 0,6 A; 24V DC |
| 236-10980-4 | motor starter 1,6 A; 24V DC |

¹⁾ For use with electrically driven, 3-phase pump, motor starter must be ordered separately.



NOTE

Further technical information, technical drawings, accessories, spare parts or product function descriptions available on SKF.com/lubrication:

15625 EN

Control unit

EOT-1 / EOT-2



Description

EOT-1 / EOT-2 are time controllers for lubrication pumps in single-line or progressive lubrication systems. EOT-1 has a fixed running time of 4 seconds and flexible pause time adjustments and, therefore, is suitable for chain lubrication. EOT-2 features flexible time settings. Both controllers are required if pumps without timers are used in lubrication systems or there is no customer-related request for pumps with an integrated pump controller. It also is suitable for retrofit installation. Simply set time using the red (running time) and a blue (pause time) switches and use the push-button to activate an additional lubrication cycle for easy and safe pump operation.

Features and benefits

- Time controller for installation in driver's cabin
- Suitable for retrofit
- Simple handling of time setting and function control

Applications

- Agriculture
- Chain lubrication systems

Technical data

| | |
|-------------------------|---------------------------------|
| Function principle | control unit |
| Supply voltage | 12/24 V DC |
| Max. current draw | ≤ 7 A |
| Protection class | IP 65 , SELV/PELV |
| Operating temperature | -25 to +70 °C; -13 to +158 °F |
| Noise suppression | class AVDE 0875 T11 |
| Interference resistance | DIN EN 61000-6-1 |
| Transient emissions | DIN EN 61000-6-3 |
| Outputs | transistor/ no |
| EEPROM | non-dissipative storage of data |

| | |
|--------------|-------------------------|
| EOT 1 | |
| Pause time | min. 5 sec, max. 75 min |
| Running time | 4 sec, unvaried |

| | |
|--------------|-------------------------|
| EOT 2 | |
| Pause time | min. 4 min, max. 15 h |
| Running time | min. 8 sec, max. 30 min |

| | |
|-----------------|--------|
| Factory setting | |
| EOT 1 | |
| Pause time | 15 sec |
| Running time | 4 sec |

| | |
|--------------|-------|
| EOT 2 | |
| Pause time | 6 h |
| Running time | 6 min |

| | |
|------------|---|
| Dimensions | 122 × 118 × 56 mm 4.8 × 4.6 × 2.2 in |
|------------|---|

| | |
|-------------------|-----|
| Mounting position | any |
|-------------------|-----|

Order information

Order number¹⁾ Designation

| | |
|--------------------|--|
| 664-34135-6 | EOT 1 controller for SKF Lincoln EOP pumps |
| 664-34135-7 | EOT 2 controller for one pump unit (not EOP) |
| 236-10980-2 | motor starter 0,6 A; 24V DC |
| 236-10980-4 | motor starter 1,6 A; 24V DC |

¹⁾ For use with electrically driven, 3-phase pump, motor starter must be ordered separately.

NOTE
 Further technical information, technical drawings, accessories, spare parts or product function descriptions available on SKF.com/lubrication:
951-181-005 EN

Control unit

85307



Description

The SKF 85307 lubrication controller provides confidence that machinery is receiving proper lubrication. Equipped with both visual and audible fault notifications, the unit's three-digit LED displays easy-to-identify codes so that lubrication system issues can be addressed quickly and efficiently. Compatible with single-line, dual-line and progressive lubrication systems, the lubrication controller has a durable, compact housing with a small footprint. Also, it is simple to install because the wiring harness attaches directly into the controller.

Optional data shuttle 85307-DS collects log files from 85307 controllers on site for later download to a PC for analysis. Up to 256 files are stored by serial number. 85307-DS also features lock/unlock 85307 controller configuration.

Features and benefits

- Easy-to-identify error codes
- Visual and audible fault notification
- Small footprint; fits in any vehicle cab
- Simple to install
- Monitors reservoir level
- Counts lubrication cycles
- Operating temperature range of -15 to $+50$ °C (5 to 122 °F)
- 12-volt or 24-volt operation
- Timing intervals from five seconds to 24 hours

Applications

- Off-road and mobile construction equipment
- General industry applications
- Chain lubrication systems
- Agriculture machinery

Technical data

| | |
|-----------------------|--|
| Order number | 85307 |
| Function principle | electronic control unit with datalogger capabilities |
| Operating temperature | -15 to $+50$ °C; $+5$ to $+122$ °F |
| Connection input | wiring harness - 14 way MOLEX MINIFIT - JR |
| Output | 4-pin connector to DataShuttle |
| Supply voltage | 12 or 24 VDC |
| Protection class | IP 54 |
| Dimensions | 70 x 145 x 38 mm 2.8 x 5.7 x 1.5 in |
| Mounting position | any |

Accessories

| Order number | Description |
|-----------------|----------------|
| 279630 | Wiring harness |
| 85307-DS | Data shuttle |



NOTE

Further technical information, technical drawings, accessories, spare parts or product function descriptions available on SKF.com/lubrication:

17963 EN, Form 404766 v2

Control unit

IG502-2-E



Description

The IG 502-2-E is a universal control and monitoring device for centralized lubrication in single-line and progressive lubrication systems. The compact device is equipped with a display panel for parameter settings and function monitoring. Different operating modes such as timer, counter and monitoring functions for pressure and cycle switches are programmable in their individual functions. The display panel is protected against moisture and dirt. A red LED shows faults as a collective message. Two integrated electronic counters are used for permanent operation control and failed hours, where pump could not operate properly. In both counters, saved times cannot be deleted. The working-hour meter summarizes times when supply voltage at the device is switched on. The device has its own database independent of supply voltage for saving configuration and parameters. To avoid environmental influences, it is advisable to install the device inside of a cabin.

Features and benefits

- Universal control and monitoring device
- Compact design
- Easy to handle operations
- Different operating modes such as timer, counter and monitoring functions
- Red LED for failure indication and cause
- Integrated counters for permanent operation, failed hours and working-hour meter show complete life cycle of system

Applications

- Commercial vehicles
- Construction machinery
- Agriculture

Technical data

| | |
|----------------------------------|---|
| Function principle | control unit |
| Control voltage | max. 12 or 24 VDC |
| Contact load connector M | 5 A at 12 or 24 VDC |
| SL-output | 4 W |
| Protection class | IP 20 DIN 40050, plug IP 00 |
| Temperature range | -25 to +75 °C; -13 to +167 °F |
| Storage temperature | -40 to +75 °C; -40 to +167 °F |
| Fuse protection | max. 5 A |
| Adjustable pause time | 0,1 h to 99,9 h |
| Adjustable pump running time | 0,1 min to 99,9 min |
| Adjustable pulse time | 1 to 999 |
| Operation hours storage | 0 to 99999,9 h |
| Operation - failed hours storage | 0 to 99999,9 h |
| Dimensions | 138 × 65 × 40 mm 5.43 × 2.56 × 1.57 in |

Order information

| Order number | Description |
|-----------------------|--------------------|
| IG 502-2-E+912 | Controller 12 V DC |
| IG 502-2-E+924 | Controller 24 V DC |
| 997-000-185 | Wire set |



NOTE

Further technical information, technical drawings, accessories, spare parts or product function descriptions available on SKF.com/lubrication:
951-180-002 EN

Control unit

LMC 2



Description

The LMC 2 is a controller for the electronic management and monitoring of lubrication systems. It combines the advantages of a specially developed printed circuit board (PCB) and a PLC in an economical, compact unit. The desired application can be selected by a dip switch. Parameters can be set by using the menu and keypad. Special set-up configurations are also available on request. Two basic models are available (24 V DC and 230 V AC). The unit is mounted in its own IP54 enclosure and does not need to be integrated in a control cabinet. Besides time dependent intervals, an integrated counter also facilitates a cycle-dependent control of the lubrication intervals. The LMC2 can be integrated into common field bus systems via procedure-neutral interfaces.

Features and benefits

- Integrated, flexible lubrication programs
- Well-structured prompting on the display for parameter settings and output signals
- 8 inputs / 5 outputs; suitable for complex lubrication systems
- Time- or cycle-dependent control of lubrication intervals
- Can be interfaced with common field bus systems
- IP54 enclosure

Applications

- Lincoln and SKF progressive systems, single-line, dual-line and multi-line systems
- Railway lubrication and spray lubrication systems
- Food and beverage
- Chain lubrication systems like Cobra and PMA

Technical data

| | |
|-----------------------|---|
| Function principle | electronic control unit |
| Operating temperature | -10 to +70 °C; +14 to +158 °F |
| Inputs | max. 8 digital inputs |
| Outputs | 4 relay outputs, 1 electronic |
| Display | 4 x 7-segment display, voltage on, ready for operation/fault, pump on, low-level signal |
| Interfaces | cable insert through 16 x multiple cable gland + 1 x PG bus interface and programming |
| Supply voltage | depending on model: 230 VAC, 24 VDC |
| Protection class | IP 54 |
| Dimensions | 200 x 120 x 90 mm 7.9 x 4.7 x 3.5 in |
| Mounting position | any |



NOTE

Further technical information, technical drawings, accessories, spare parts or product function descriptions available on SKF.com/lubrication:

14004 EN

Control unit

LMC 2

Order information

| Order number ¹⁾ | Designation |
|----------------------------|------------------------|
| 236-10567-6 | LMC 2 230 AC (230 VAC) |
| 236-10567-5 | LMC 2 24 DC (24 VDC) |

¹⁾ For use with electrically driven, 3-phase pump, a motor starter must be ordered separately.

Accessories

| Order number | Designation |
|--------------------|-------------------------------|
| 236-10980-2 | motor starter 0,6 A; 24V DC |
| 236-10980-4 | motor starter 1,6 A; 24V DC |
| 236-10980-7 | motor starter 0,6 A; 230 V DC |
| 236-10980-8 | motor starter 1,0 A; 230 V DC |
| 236-10980-9 | motor starter 1,6 A; 230 V DC |
| 236-10980-6 | motor starter 4,0 A; 230 V DC |

Control unit

LMC 301



Description

The LMC 301 is a compact, modularly expandable control and monitoring device. The device is equipped with an LCD display and six functional keys for programming, parameter setting and signalization. The user is guided through the setting menu. Also, there is a simple-to-use PC software for parameter setting and diagnostics available.

Features and benefits

- Integrated, flexible lubrication programs
- Basic device with 10 digital inputs, of which two can be used analogously, and eight outputs
- Up to seven extension modules can be added, whereby each module has 10 E 8 A just like the basic device
- Three lubrication pumps can be controlled and monitored, each of which provides up to three lubrication circuits
- Single modules are connected by a bus interface

Applications

- Cement and steel, food and beverage industry
- Mining; stationary and mobile excavators

Technical data

| | |
|---------------------------|--|
| Function principle | electronic control unit |
| Operating temperature VAC | -10 to +50 °C; +14 to +122 °F |
| Operating temperature VDC | -40 to +70 °C; -40 to +158 °F |
| Inputs | 10 count, short-circuit |
| Outputs | 8 counts, relay outputs NO-contact 8 A, 2 of which up to 20 A |
| Supply voltage | depending on model: 90-264 VAC, 24 VDC ± 20% |
| Protection class | IP 65 |
| Dimensions | 270 × 170 × 90 mm 10.7 × 6.7 × 3.5 in |
| Mounting position | vertical |

Order information

| Order number | Designation |
|---------------|--|
| 086500 | LMC 301; 24 V DC, master, incl. LCD display |
| 086501 | LMC 301; 100-240 VAC, master, incl. LCD display |
| 086502 | LMC 301; 24 V DC, I/O board, slave, without display |
| 086503 | LMC 301; 100-240 AC, I/O board, slave, without display |

NOTE

Further technical information, technical drawings, accessories, spare parts or product function descriptions available on SKF.com/lubrication:
15967 EN, 951-150-029 EN

LMC 301 - Accessories



LMC 301 motor relay assembly

| Order number | Description |
|--------------|------------------------------|
| 236-10850-7 | with motor starter 0,4–0,6 A |
| 236-10850-8 | with motor starter 0,6–1,0 A |
| 236-10850-9 | with motor starter 1,0–1,6 A |
| 236-10980-6 | with motor starter 2,4–4,0 A |

LMC 301 housing

| Order number | Description |
|--------------|------------------------|
| 086500 | door housing, complete |
| 086505 | cable USB |

Motor starter 24V

| Order number | Designation |
|--------------|-----------------------------|
| 236-10980-2 | motor starter 0,6 A; 24V DC |
| 236-10980-4 | motor starter 1,6 A; 24V DC |

Motor starter 230V

| Order number | Designation |
|--------------|-------------------------------|
| 236-10980-7 | motor starter 0,6 A; 230 V DC |
| 236-10980-8 | motor starter 1,0 A; 230 V DC |
| 236-10980-9 | motor starter 1,6 A; 230 V DC |
| 236-10980-6 | motor starter 4,0 A; 230 V DC |

General LMC 301 accessories

| Order number | Description |
|---|--|
| 086506 086507 | PG-M20 Cable gland kit, IP 65 Multiple cable gasket set (3 x) Cable gasket set (3 x) |
| 3515-10-6020 3515-10-6620 | Cable glands PG-M20; complete, with cap nut, cable gasket set, screw plug cartridge Cable gasket set; 2-wire, Ø 0.6 mm Cable gasket set; 4-wire, Ø 0.5 mm |
| 3515-10-7620 3515-10-6320 3515-10-6120 | Blind plug Gasket Counter nut |
| 3515-07-6120 3515-10-2021 3515-07-2022 236-11066-1 | Conduit glands, IP 65, with flexible metal tube (FMC), UL approved Conduit glands AMG-M 20 x 1,5; UL 514B Counter nut M 20 x 1,5 Protection hose, liquid-proof protective; UL 360 (sold by the metre, when ordering specify the required length) Battery, 3 V lithium button cell, model CR3032 |
| www.skf.com/LMC301 | LMC 301 software, free download |

1) The installation of the cable glands and cable sets to be provided and done by the customer. The customer is responsible for proper installation.



Overview of pressure sensors

Mechanical pressure sensors with digital output signal

| Product | Lubricant | | Pressure ranges | | Operating temperature | | Voltage | | Contact type | Page |
|--------------|-----------|--------|-----------------|-----------|-----------------------|-------------|---------|-------------|--------------|------|
| | oil/fluid | grease | bar | psi | °C | °F | VDC | VAC | | |
| DSA | • | – | 1–45 | 14.5–650 | +10 to +60 | +50 to +140 | 30 | 250 | change-over | 164 |
| DSD | • | – | 0,5–45 | 7.25–650 | -30 to +100 | -22 to +212 | 36 | 250 | change-over | 166 |
| DSB | – | • | 20–300 | 290–4 350 | -25 to +80 | -13 to +176 | 36 | 30 | change-over | 168 |
| 69630 | • | • | 19–207 | 275–3 000 | -25 to +65 | -13 to +149 | – | 125/250/480 | NO/NC | 170 |

Digital pressure sensors with digital or analogue output signal

| Product | Lubricant | | Pressure ranges | | Operating temperature | | Voltage | | Contact type | Page |
|----------------------|-----------|--------|-----------------|-----------|-----------------------|-------------|---------|-----|---------------|------|
| | oil/fluid | grease | bar | psi | °C | °F | VDC | VAC | | |
| DSC1 | 1) • | – | 0–40 | 0–580 | -25 to +80 | -13 to +176 | 18–30 | – | 2xPNP | 171 |
| DSC2 | 2) • | – | 0–300 | 0–4 350 | -10 to +80 | +14 to +176 | 18–30 | – | 2xPNP/NPN | 172 |
| DSC3 | 2) • | – | 0–300 | 0–4 350 | -25 to +80 | -13 to +176 | 9–35 | – | 2xPNP | 173 |
| 234-13161-9 | 2) • | • | 0–250 | 0–3 625 | -25 to +80 | -13 to +176 | 20–32 | – | NO/NC 4–20 mA | 174 |
| 2340-00000118 | 1) • | • | 0–400 | 0–5 800 | -40 to +85 | -40 to +185 | 18–30 | – | NO/NC 4–20 mA | 175 |
| 234-10330-4 | 1) • | – | 0–600 | 0–8 700 | -20 to +85 | -4 to +185 | 24 | – | NO/NC 4–20 mA | 176 |
| 234-11272-4 | 1) • | • | 10–600 | 145–8 700 | -25 to +100 | -13 to +212 | 18–32 | – | NO/NC 4–20 mA | 177 |
| 234-13161-5 | 2) • | • | 0–600 | 0–8 700 | -25 to +80 | -13 to +176 | 20–32 | – | NO/NC 4–20 mA | 178 |
| 2340-00000108 | 1) • | • | 0–600 | 0–8 700 | -40 to +85 | -40 to +185 | 18–30 | – | NO/NC 4–20 mA | 179 |

1) Pressure sensor with analogue and digital output signal

2) Pressure sensor with digital output signal

Pressure sensor

DSA



Description

DSA pressure switches monitor the pressure of a lubrication system and help assess its proper function. They monitor parameters as pressure buildup, pressure head and pressure reduction e.g. in intermittently operated lubrication systems with single-line oil metering devices. Switching pressures are factory set for plug&play operation. The pressure cell containing the membrane and the pressure plunger are assembled with the microswitch in compact plastic housings. The housings are made of glass fiber-reinforced polyamide and contain mounting feet for quick and easy mounting.

Features and benefits

- Easy to wire and install
- Simple and efficient design
- Cost-efficient market proven solution
- Micro switch for reliable switching function
- Change-over switch, suitable for both normally closed contact (NC) and normally open contact (NO)
- Switching pressure factory set for plug&play operation
- Available for rising and falling pressures from 1 to 30 bar (14.5 to 435 psi)

Applications

- Machine tools
- Printing machines
- Wind
- Vehicle
- Steel and heavy industries



Technical data

| | |
|----------------------------------|--|
| Function principle | diaphragm pressure switch |
| Lubricant | oil and fluid grease NLGI 000-0, oiled compressed air |
| Operating temperature | 10 to 60 °C; 50 to 140 °F |
| Operating pressure ¹⁾ | max. 45 bar; 650 psi |
| Switching pressure range | 1-30 bar; 14.5-435 psi |
| Switching pressure tolerances | 1 bar+0.3; 2 bar+0.5; 3 bar-0.5; 5 bar±0.5; ≥ 8 bar+0.5/-1.5 |
| Switching rate | max. 30 switching cycles per min |
| Operating voltage | max. 250 VAC; max. 30 VDC |
| Operating current | max. 300 mA, min. 2 mA |
| Safety class | II (IEC 61140) |
| Breaking capacity | max. 125 VA |
| Pressure port | DIN 3862 connector or SKF Quick Connector for tube Ø6 mm |
| Electrical connection | M12x1 or cubical plug |
| Switch type | micro switch |
| Contact type | change-over |
| Mechanical service life | 5 × 10 ⁶ switching cycles |
| Materials: | |
| Housing | PA6 6GF30 |
| Contact | AuAg25Pt6 |
| Membrane | FKM (FPM) |
| Protection class | IP 65 |
| Dimensions | min. 76 × 120 × 41 mm; 3.0 × 4.7 × 1.6 in max. 83 × 129 × 41 mm; 3.3 × 5.1 × 1.6 in |
| Mounting position | any |

- ¹⁾ A pressure-regulating valve must be installed in the system to prevent operating pressure from exceeding the permissible level
²⁾ M 12x1 circular plug, only for design with electrical connection center



NOTE

Further technical information, technical drawings, accessories, spare parts or product function descriptions available on SKF.com/lubrication:

1-1701-EN



3D

skf-lubrication.partcommunity.com/3d-cad-models

Pressure sensor

DSA

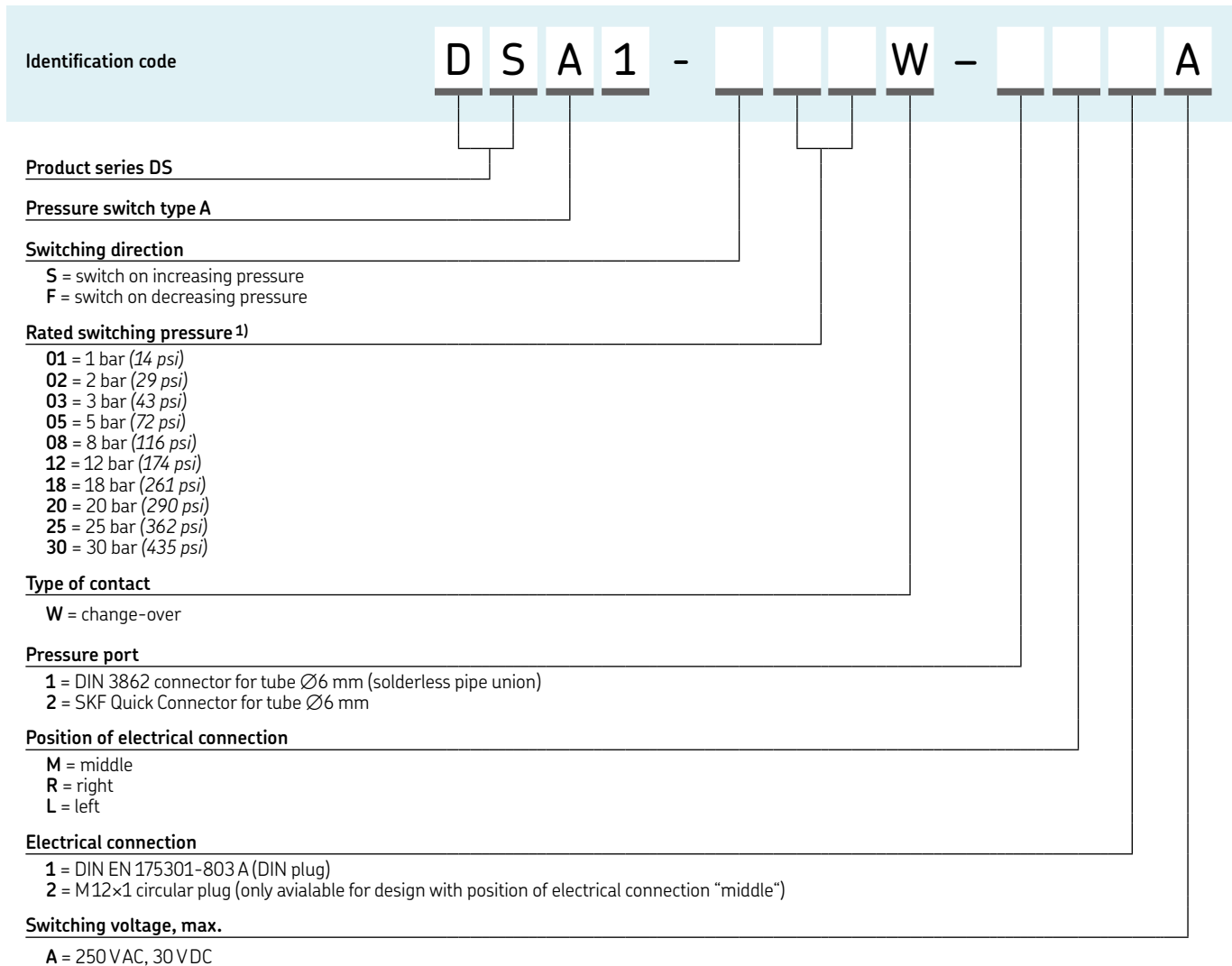

¹⁾ Switching pressure tolerances 1 bar^{+0.3}; 2 bar^{+0.5}; 3 bar^{-0.5}; 5 bar^{+0.5}; ≥ 8 bar^{+0.5/-1.5}

Pressure sensor

DSD



Description

DSD sensors are single, mechanical-diaphragm pressure switches. They are used for pressure monitoring and vary in regard of pre-adjusted pressures, electrical connections and dimensions. Under pressure, a pressure plunger carries the contact washer and moves it to the opposing contact and closes the electrical circuit. If the pressure is reduced by the amount of hysteresis, the switch opens again. On an NC contact, contacts are made in the opposite way. In single-line systems, DSD sensors can be integrated before the last metering device at the end of the lubrication line.

Features and benefits

- Very small and compact design
- Available for a pressure rating from 0 to 45 bar (0 to 653 psi) in fixed increments
- Electrical connection is established via screwed contacts, tab connectors, circular or cubic plug connectors
- Pressure monitoring, dependent upon the mechanical design of resulting pressure and preloaded spring force of the pressure spring
- Mechanical switch can be used as both a normally closed contact (NC) and a normally open contact (NO)

Applications

- Machine tools
- Printing machines
- Minerals and mining
- Food and beverage
- Wind turbines



Technical data

| | |
|----------------------------|---|
| Function principle | digital pressure switch |
| Lubricant | oil and fluid grease NLGI 000, 00, 0 |
| Operating temperature: | |
| FKM membrane | -10 to +100 °C; -13 to +212 °F |
| NBR membrane | -25 to +100 °C; 14 to 212 °F |
| Operating pressure | max. 150 bar; max. 2 175 psi |
| Overpressure | max. 300 bar; max. 4 350 psi |
| Switching pressure | 0,5 to 45 bar; 7.25 to 653 psi |
| Switch type | mechanical diaphragm pressure switch |
| Contact type | NO, NC (change-over with cubic plug connector only) |
| Contact rating: | |
| DSD3-A...A12/DSD3-A...A14 | 100 VA |
| DSD3-A...A13 | 24 VA |
| Switching voltage/current: | |
| DSD3-A...A12 | 48V DC/AC 2,5 A (min. 20 mA) |
| DSD3-A...A13 | 48V DC/AC 0,5 A (min. 20 mA) |
| DSD3-A...A14 | 30V DC 2,5 A/250V AC 5 A (min. 20 mA) |
| Electrical connection: | |
| DSD3-A...A12 | combination plug - tab connector 6,3 × 0,8 mm or M3 screw |
| DSD3-A...A13 | M12×1 plug |
| DSD3-A...A14 | cubic plug DIN EN 175301-803-A |
| Pressure port | M10×1 tapered |
| Materials: | |
| Housing | steel, galvanized, Cr6-free |
| Contact | silver plated |
| Membrane | NBR or FKM |
| Protection class (housing) | IP 65 |
| Dimensions, Ø × h: | |
| DSD3-A...A12 | 26,75 × 50 mm; 1.05 × 1.97 in |
| DSD3-A...A13 | 26,75 × 71 mm; 1.05 × 2.79 in |
| DSD3-A...A14 ¹⁾ | 26,75 × 85 mm; 1.05 × 3.34 in |
| Mounting position | any |

¹⁾ Dimensions without cubic plug

Pressure sensor

DSD

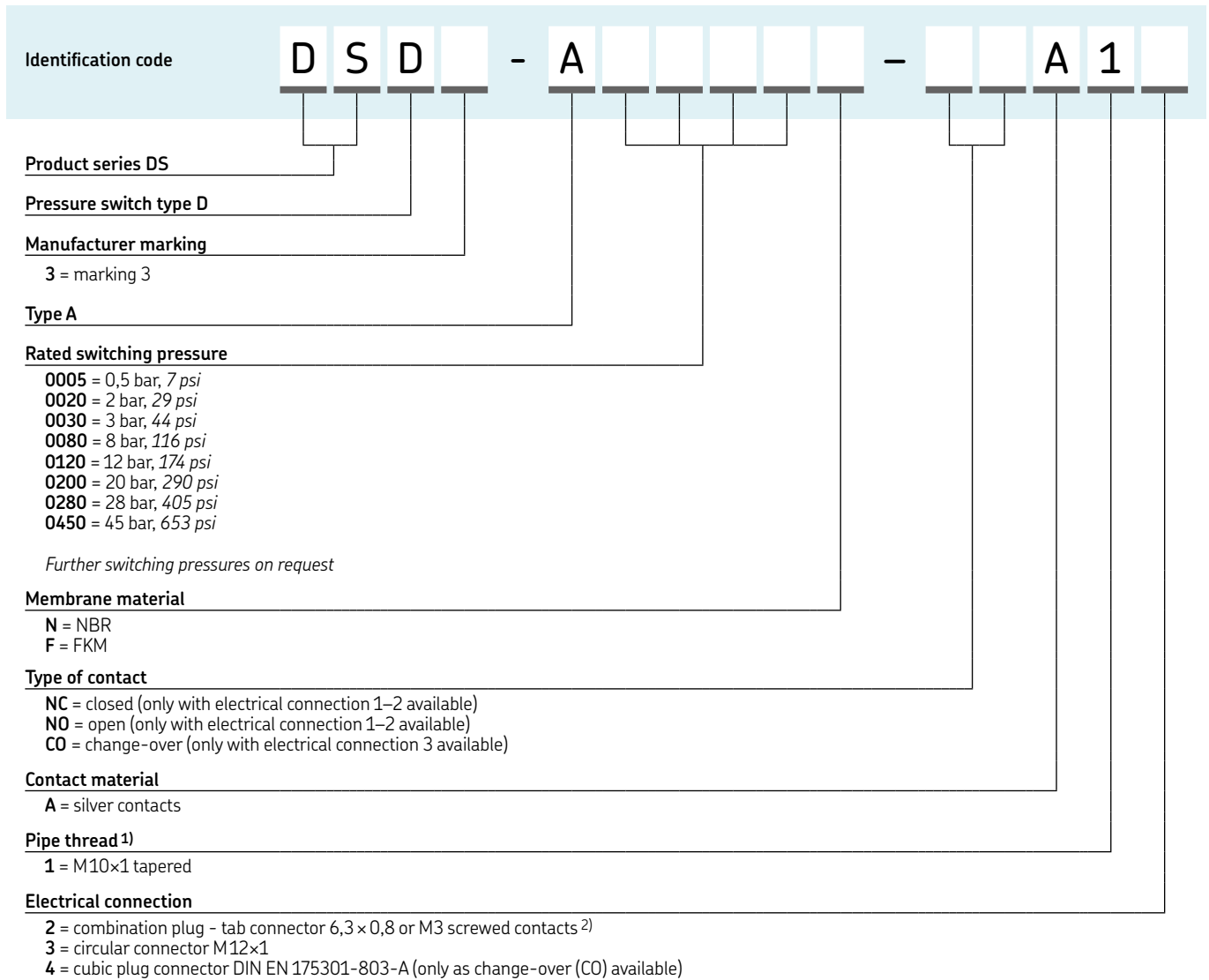

¹⁾ More versions available on request.
²⁾ Protection cap 898-420-001 to be ordered separately

NOTE
 Further technical information, technical drawings, accessories, spare parts or product function descriptions available on SKF.com/lubrication:
19175EN
 3D
skf-lubrication.partcommunity.com/3d-cad-models

Pressure sensor

DSB



Description

SKF pressure switches of product series DSB are mechanical piston pressure switches that are specially designed for use with NLGI 1-2 greases. The location of the actuating piston inside the pressure switch housing helps to ensure a continuous exchange of grease around the measuring point (pressurization point between grease and actuating piston). This reliably prevents the same grease from being pressurized repeatedly, which could cause grease bleeding (separation of the soap skeleton of the grease from the stored oil). Pressure switches of product series DSB are designed for corrosivity category C3 or C5M per ISO 12944.

Features and benefits

- Adaptable to VR lubricant metering devices due to same hole pattern, wall distance and connections
- Micro switch is designed as a change-over switch; can be used as both a normally closed contact (NC) and a normally open contact (NO)
- Available for rising and falling pressures from 20 to 300 bar in 10-bar increments
- No grease bleeding at measuring point
Pressure switch permits continuous lubricant flow without dead space
- Suitable for use with unstable greases with a tendency to separate into soap and oil under high pressure

Applications

- Machine tools
- Printing machines
- Wind
- Vehicle
- Steel and heavy industries

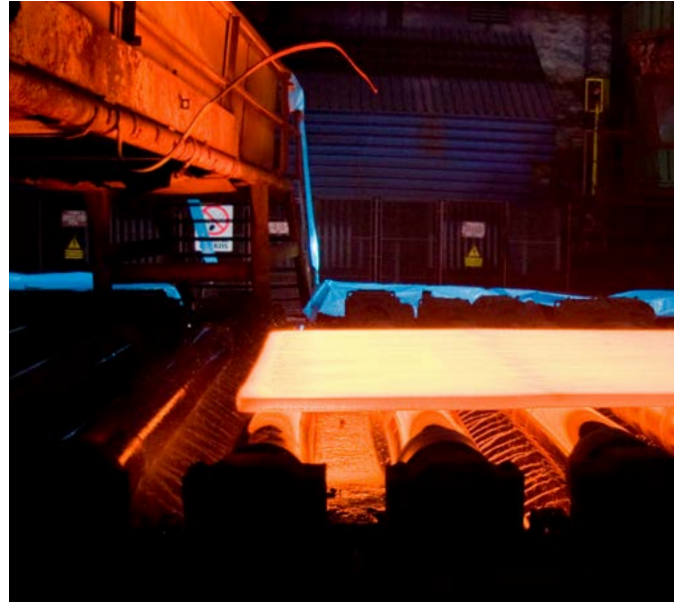

Technical data

| | |
|--------------------------|---|
| Function principle | digital pressure switch |
| Lubricant | grease NLGI 1, 2 |
| Operating temperature | -25 to +80 °C; -13 to +176 °F |
| Operating pressure | max. 300 bar; 4 350 psi |
| Operating voltage | max. 30 VAC; max. 36 VDC |
| Operating current | max. 50 mA, min. 1 mA |
| Breaking capacity | max. 1,2 VA |
| Mechanical service life | 10 ⁵ switching cycles |
| Pressure port | G 1/4 (F) |
| Electrical connection | connector socket 3+PE; DIN EN 175 301-803 A cable: Ø 4.5 to 7 mm; Ø 0.177 to 0.275 in |
| Switch type | micro switch |
| Contact type | change-over |
| Switching pressure range | 20 to 300 bar; 290 to 4 350 psi; increasing and decreasing |
| Materials: | |
| Housing | aluminum, anodized |
| Contact | silver alloy, hard gold plating |
| Protection class | IP 65; DIN EN 60529 |
| Dimensions | depending on model min. 60 × 105 × 76 mm; max. 150 × 153 × 76 mm; min. 2.36 × 4.13 × 2.99 in max. 5.90 × 6.02 × 2.99 in |
| Mounting position | any |
| Certification | Germanischer Lloyd (GL) |



NOTE

Further technical information, technical drawings, accessories, spare parts or product function descriptions available on SKF.com/lubrication:

1-1701-EN



3D

skf-lubrication.partcommunity.com/3d-cad-models

Pressure sensor

DSB

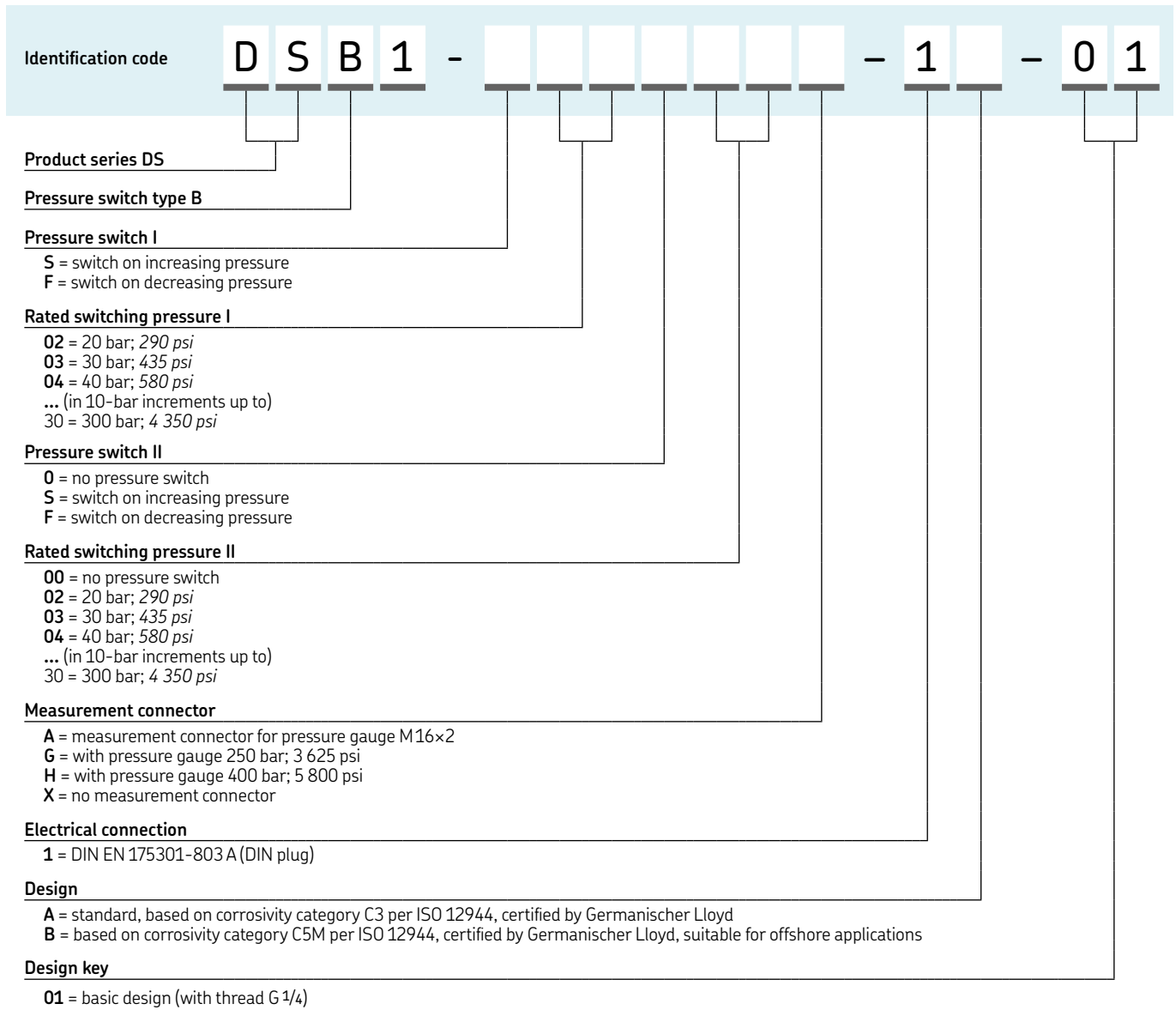

Pressure sensor

69630

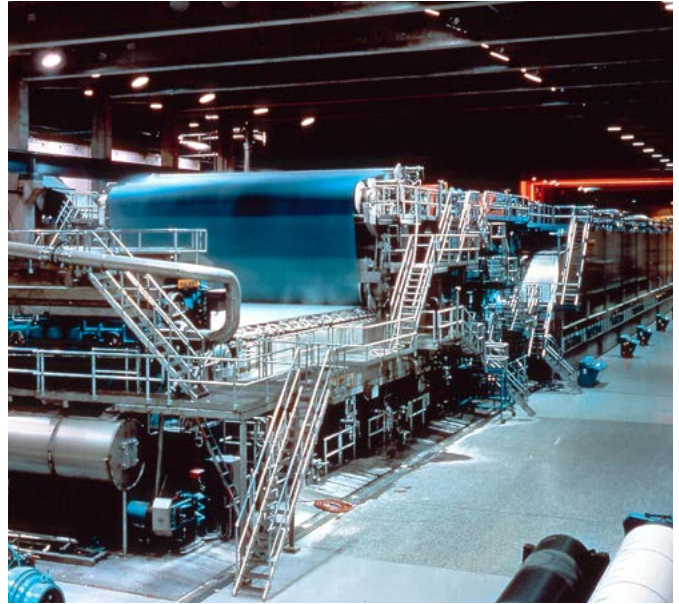

Description

Pressure switch 69630 senses supply line pressure when pressure is rising or falling. One single contact signals system operation to controller or system alarm.

Features and benefits

- Simple pressure switch
- Adjustable pressure ranges for decreasing and increasing pressures to match system requirements
- Use as single pressure switch or in a system with controller and solenoid valve

Applications

- Paper converting
- Plastic processing
- Printing
- Packaging
- Metalworking
- Material handling equipment

Technical data

| | |
|-----------------------|---|
| Order number | 69630 |
| Function principle | digital pressure switch |
| Operating temperature | -25 to +65 °C -13 to +150 °F |
| Switching capacity | 125, 250 or 480 VAC: 10 A 6 VDC: 15 A 24 VDC: 5 A 250 VDC: 0,3 A |
| Operating pressure: | |
| decreasing | max. 190 bar max. 2 775 psi |
| increasing | max. 207 bar max. 3 000 psi |
| Pressure port | 1/4 NPTF (F) |
| Electrical connection | 27/32 in hole for conduit connector 1/2 in |
| Protection class | housing and UL-listed switching elements: NEMA 3 |
| Dimensions | 57 × 146 mm 2.25 × 5.75 in |
| Mounting position | vertical |



NOTE

Further technical information, technical drawings, accessories, spare parts or product function descriptions available on SKF.com/lubrication:

442832

Pressure sensor

DSC1



Description

DSC1 pressure switches are electronic pressure switches with integrated digital display for relative pressure measurement. They are used primarily for pressure monitoring. Depending on the design, they also can assume control functions. Pressure switch points, pressure indication, and the switching logic can be configured and programmed easily. The values are displayed as 4-digit alphanumeric characters, at the same time there is an alternating display (red / green) to indicate the switching status. DSC1 can be operated with both hysteresis and window functions and the mode can be set separately for each switching output.

Features and benefits

- IO-Link
- Available for rising and falling pressures from 1 to 40 bar in 0,5 bar increments
- Can be operated with both, hysteresis and window function modes
- Encodable access protection
- Digital and analog output

Applications

- Machine tools
- Printing machines
- Wind
- Vehicle
- Steel and heavy industries

Technical data

| | |
|-----------------------|---|
| Order number | DSC1-B040E-2A2B |
| Function principle | analogue/digital pressure switch |
| Lubricant | oil and fluid grease NLGI 000, 00, 0 |
| Operating temperature | -25 to +80 °C -13 to +176 °F |
| Operating pressure | 1-40 bar in 0,5 bar steps 14-580 psi in 7 psi steps |
| Burst pressure | 500 bar; 7 251 psi |
| Operating voltage | 18 to 30 VDC |
| Power consumption | max. 35 mA |
| Output signal | 2 signal outputs; 1 x PNP transistor stages or IO-Link |
| Vibration resistance | 20 g (10-2 000 Hz) |
| Service life | 100 × 10 ⁶ pressure changes |
| Material: | |
| Housing | stainless steel |
| Control panel | polycarbonate |
| Electrical connection | M12×1; 4-pin |
| Pressure port | G 1/4 |
| Protection class | IP 67 |
| Dimensions | 34 × 91 × 49,4 mm 1.33 × 3.58 × 37.4 in |
| Mounting position | any |



NOTE

Further technical information, technical drawings, accessories, spare parts or product function descriptions available on SKF.com/lubrication:

1-1701-EN

Pressure sensor

DSC2



Description

DSC2 sensors are electronic pressure switches with an integrated digital display for relative pressure measurement. They are used primarily for pressure monitoring. Depending on the design, they also can assume control functions. Pressure switch points, pressure indication and the switching logic can be configured and programmed easily. The four-digit, digital display that indicates switching with LEDs. DSC2 can operate in switching point, hysteresis and window function modes. The switching mode can be programmed separately for each output.

Features and benefits

- Available for rising and falling pressures from 0 to 100 bar in 0.5-bar increments
- Four-digit, digital display indicates switching with LEDs
- Can operate in switching point, hysteresis and window function modes
- Diagnostic output based on the DESINA specification
- CE and UL certification

Applications

- Machine tools
- Printing machines
- Wind
- Vehicle
- Steel and heavy industries



Technical data

| | |
|-----------------------|--|
| Order number | DSC2-A100E-2A2B |
| Function principle | digital pressure switch |
| Lubricant | oil and fluid grease NLGI: 000-0 |
| Operating temperature | -10 to +80 °C +14 to 176 °F |
| Operating pressure | max. 300 bar max. 4 350 psi |
| Operating voltage | 18 to 30 VDC |
| Power consumption | max. 35 mA |
| Output signal | 2 x PNP/NPN |
| Vibration resistance | 20 g (10-2 000 Hz) |
| Service life | 100 × 10 ⁶ pressure changes |
| Material: | |
| Housing | aluminum, stainless steel |
| Control panel | polyester film |
| Electrical connection | M12×1, 4-pin |
| Pressure port | G 1/4 (F) |
| Protection class | IP 67 |
| Dimensions | 34 × 90,7 × 49,4 mm 1.33 × 3.57 × 37.4 in |
| Mounting position | any |

NOTE

Further technical information, technical drawings, accessories, spare parts or product function descriptions available on SKF.com/lubrication:

1-1701-EN



3D

skf-lubrication.partcommunity.com/3d-cad-models

Pressure sensor

DSC3



Description

DSC3 sensors are electronic pressure switches with an integrated digital display for relative pressure measurement. They are used primarily for pressure monitoring. Depending on the design, they also can assume control functions. Pressure switch points, pressure indication and the switching logic can be configured and programmed easily. The display is a pivoted, four-digit, digital display. DSC3 can be integrated into lubrication line. It operates in switching point, hysteresis, and window function modes. The switching mode can be programmed separately for each output.

Features and benefits

- Available for rising and falling pressures from 0 to 100 bar in 0.5-bar increments
- Easy to install into a lubrication line
- Pivoted, four-digit, digital display
- Can operate in switching point, hysteresis and window function modes
- Programming lock to protect against unauthorized adjustment of drive
- Switching displayed using LEDs

Applications

- Machine tools
- Printing machines
- Wind
- Vehicle
- Steel and heavy industries

Technical data

| | |
|-----------------------|---|
| Order number | DSC3-A100K-3A2B |
| Function principle | digital pressure switch |
| Lubricant | oil and fluid grease NLGI: 000-0 |
| Operating temperature | -25 to +80 °C -13 to 176 °F |
| Operating pressure | max. 300 bar max. 4 350 psi |
| Operating voltage | 9 to 35 VDC |
| Power consumption | max. 35 mA |
| Output signal | 2 x PNP transistor stages |
| Vibration resistance | 20 g (5-500 Hz) |
| Service life | 100 × 10 ⁶ pressure changes |
| Material: | |
| Housing | plastic |
| Electrical connection | M12×1, 4-pin |
| Pressure port | via t connector, 2 × G 1/8 (F) |
| Protection class | IP 67 |
| Dimensions | 42 × 115 × 40 mm 1.65 × 4.53 × 1.57 in |
| Mounting position | any |



NOTE

Further technical information, technical drawings, accessories, spare parts or product function descriptions available on SKF.com/lubrication:

1-1701-EN



3D

skf-lubrication.partcommunity.com/3d-cad-models

Pressure sensor

234-13161-9



Description

This compact, maintenance-free electronic pressure switch has a 3-digit, digital display, one switching output and an analog output signal for switching point and hysteresis. Both can be adjusted via push buttons. For optimum adaptation to a particular application, the instrument has many additional adjustment parameters, e.g. switching delay times, NO and NC function of the outputs.

Features and benefits

- Integrated pressure sensor with thin-film strain gauge on stainless steel membrane
- 3-digit, digital display
- Independently adjustable switch-back hysteresis and switching point
- Reverse polarity protection of the supply voltage, excess voltage, override and short-circuit protection are provided
- Password protected
- Directly installable via G 1/4 adapter into pressure line

Applications

- Marine and off-shore applications
- Steel and heavy industries
- Wind turbines
- Service vehicles

Technical data

| | |
|-----------------------|--|
| Order number | 234-13161-9 |
| Function principle | digital pressure switch |
| Lubricant | oil, fluid grease and grease up to NLGI 2 |
| Operating temperature | -25 to +80 °C; -13 to +175 °F |
| Operating pressure | max. 250 bar; max. 3 625 psi |
| Operating voltage | 20-32 VDC |
| Output signal | 1 × PNP, 4-20 mA |
| Current consumption | approx. 100 mA (without switching outlet) |
| Electrical connection | plug DIN 43650 (3pin+ PE) or plug 4-pin binder 714, M18 × 1 |
| Pressure port | G1/4 |
| Protection class | IP 65 |
| Dimensions | 35 × 119 × 48 mm 1.37 × 4.68 × 1.89 in |
| Mounting position | any |



NOTE

Further technical information, technical drawings, accessories, spare parts or product function descriptions available on SKF.com/lubrication.

Pressure sensor

2340-00000118



Description

This maintenance-free analogue pressure sensor is suitable for pressure measurements for gases and fluids. It is user friendly and can be applied easily in standard or superior applications. The space-saving housing is pivotable up to 320° for optimal readability of the 4-digit, digital display. Switching output for analogue or digital signals incl. IO-Link. It comes with reverse polarity protection of the supply voltage, excess voltage, override and short circuit protection. Different value units such as bar, mbar, psi or MPa can be selected.

Features and benefits

- IO-link incl. counter for operating hours, pressure peaks and inner temperature
- Menu-guided adjustments via push buttons
- Pre-adjustable hysteresis
- Programmable parameters, password protected
- Compact housing with 320° pivot

Applications

- Marine and off-shore applications
- Steel and heavy industries
- Wind turbines
- Service vehicles

Technical data

| | |
|-----------------------|---|
| Order number | 2340-00000118 |
| Function principle | analogue/digital pressure switch, flush oil, fluid grease and grease up to NLGI 2 |
| Lubricant | CE, EAC, UL/CSA |
| Approval | CE, EAC, UL/CSA |
| Operating temperature | -40 to +85 °C; -40 to +185 °F |
| Operating pressure | max. 400 bar; max. 5 800 psi |
| Overload pressure | 600 bar; 8 700 psi |
| Burst pressure | 1 000 bar; 14 500 psi |
| Operating voltage | 18-30 VDC |
| Operating current | max. 150 mA |
| Current draw | ≤ 50 mA |
| Output signal | 2x PNP/NPN (NO/NC) adjustable |
| Analogue Output | voltage 0 .. 10 V / current 4 .. 20 mA adjustable |
| Interface | IO-Link 1.1 |
| Switching frequency | 170 Hz |
| Switching cycles | 100 Mio. |
| Material: | |
| Housing | PA6.6, stainless steel 1.4301, FKM |
| Measuring cell | Stainless steel 1.4435 |
| Electrical connection | M12x1; 4-pole, A-coded |
| Pressure port | G1/2 |
| Protection class | IP 67 |
| Dimensions | 116 x 34 x 49 mm 4.56 x 1.33 x 1.92 in |
| Mounting position | any |



NOTE

Further technical information, technical drawings, accessories, spare parts or product function descriptions available on SKF.com/lubrication.

Pressure sensor

234-10330-4



Description

This electronic pressure switch has a 4-digit, digital display, two switching outputs and an analog output signal for switching point and hysteresis. Both can be adjusted via push buttons. The water-proofed housing is pivotable up to 290° for optimal readability of digital display. The pressure switch is virtually maintenance free.

Features and benefits

- Menu-guided adjustments via 3 push buttons indicating status of outputs
- Peak value storage
- Adjustable hysteresis and absorption
- Programmable parameters
- Password protected
- Reverse polarity and overvoltage protected; short-circuit proof

Applications

- Machine tools
- Printing machines
- Wind
- Vehicles
- Steel and heavy industries

Technical data

| | |
|-----------------------|---|
| Order number | 234-10330-4 |
| Function principle | analogue/digital pressure switch |
| Lubricant | oil, fluid grease and grease up to NLGI 2 |
| Operating temperature | -20 to +85 °C; -4 to +185 °F |
| Operating pressure | 0–600 bar; 0–8 700 psi |
| Overload pressure | 1 200 bar; 17 400 psi |
| Burst pressure | 2 400 bar; 34 800 psi |
| Analog output signal | 0/4–20 mA, apparent ohmic resistance ≤ 500 Ω |
| Operating voltage | 15–30 VDC, nominal 24 VDC |
| Signal output type | PNP-Transistor |
| Switching current | max. 0,7 A |
| Current consumption | < 100 mA |
| Switching cycle | ≥ 20 Mio. |
| Electrical connection | M12 × 1; 5 pin |
| Pressure port | G 1/4 (BSPP) |
| Material: | |
| Housing | stainless steel 1.4404, NBR |
| Control panel | zinc die casting, surface treated |
| Protection class | IP 67 |
| Dimensions | 39,5 × 105,5 × 46,3 mm 1,55 × 4,15 × 1,82 in |
| Mounting position | any |



NOTE

Further technical information, technical drawings, accessories, spare parts or product function descriptions available on SKF.com/lubrication.

Pressure sensor

234-11272-4



Description

The electronic pressure switch with internal stainless steel diaphragm, suits for pressure control in automatic single-line lubrication systems. It has a 4 digit 7 segment digital display, two solid state contacts or two solid state contacts plus one analog output for switching point and hysteresis. All contacts can be adjusted via push buttons. The pressure switch is virtually maintenance free.

Features and benefits

- Alphanumeric 4-digit 7 segment LED display
- Microprocessor controlled
- Self monitoring with error display
- Scalable analog output
- Programmable parameters via keypad
- Adjustable password protection
- Revers polarity and overvoltage protected, short-circuit proof max 60 VDC temporary
- Rugged stainless steel construction
- Vibration and shock-proof, longterm stability

Applications

- Machine tools
- Chemical technics
- Wind, vehicle, steel and heavy industries
- Automation

Technical data

| | |
|-----------------------|---|
| Order number | 234-11272-4 |
| Function principal | electrically operated dual output signal analogue/digital pressure switch |
| Lubricant | oil, fluid grease and grease up to NLGI 2 |
| Operating temperature | -25 to +100 °C ; -13 to +212 °F |
| Operating pressure | 10 to 600 bar; 145 to 8702 psi |
| Operating elements | 3 easy-response push buttons |
| Protection class | IP 65 with plug |
| Pressure port | G 1/4 M |
| Electrical connection | M12 x 1; for 4 pin or 5 pin plug |
| Current output | 4-20 mA, apparent ohmic resistance 600 Ω at 24 VDC |
| Power supply | 18-32 VDC reversed polarity protected (SELV, PELV) |
| Digital display | 4-digit 7 segment LED display |
| Power consumption | approx. 50 mA at 24 VDC without load |
| Material: | |
| Wetted parts | stainless steel 1.4301 |
| Electronics housing | aluminum die-cast |
| Seals | FKM |
| Dimensions | 75 x 130 x 55 mm 2.95 x 5.12 x 2.16 in |
| Mounting position | vertical |



NOTE

Further technical information, technical drawings, accessories, spare parts or product function descriptions available on SKF.com/lubrication.

Pressure sensor

234-13161-5



Description

This compact, maintenance-free electronic pressure switch has a 3-digit, digital display, one switching output and an analog output signal for switching point and hysteresis. Both can be adjusted via push buttons. For optimum adaptation to a particular application, the instrument has many additional adjustment parameters, e.g. switching delay times, NO and NC function of the outputs.

Features and benefits

- Integrated pressure sensor with thin-film strain gauge on stainless steel membrane
- 3-digit, digital display
- Independently adjustable switch-back hysteresis and switching point
- Reverse polarity protection of the supply voltage, excess voltage, override and short-circuit protection are provided
- Password protected
- Directly installable via G 1/4 adapter into pressure line

Applications

- Marine and off-shore applications
- Steel and heavy industries
- Wind turbines
- Service vehicles



Technical data

| | |
|-----------------------|--|
| Order number | 234-13161-5 |
| Function principle | digital pressure switch |
| Lubricant | oil, fluid grease and grease up to NLGI 2 |
| Operating temperature | -25 to +80 °C; -13 to +175 °F |
| Operating pressure | max. 600 bar; max. 8 700 psi |
| Operating voltage | 20-32 VDC |
| Output signal | 1 × PNP, 4-20 mA |
| Current consumption | approx. 100 mA (without switching outlet) |
| Electrical connection | plug DIN 43650 (3pin+ PE) or plug 4-pin binder 714, M18 × 1 |
| Pressure port | G1/4 |
| Protection class | IP 65 |
| Dimensions | 35 × 119 × 48 mm 1.37 × 4.68 × 1.89 in |
| Mounting position | any |



NOTE

Further technical information, technical drawings, accessories, spare parts or product function descriptions available on SKF.com/lubrication.

Pressure sensor

2340-00000108



Description

This maintenance-free analogue pressure sensors is suitable for pressure measurements for gases and fluids. It is user friendly and can be applied easily in standard or superior applications. The space-saving housing is pivotable up to 320° for optimal readability of the 4-digit, digital display. Switching output for analogue or digital signals incl. IO-Link. It comes with reverse polarity protection of the supply voltage, excess voltage, override and short circuit protection. Different value units such as bar, mbar, psi or MPa can be selected.

Features and benefits

- IO-link incl. counter for operating hours, pressure peaks and inner temperature
- Menu-guided adjustments via push buttons
- Pre-adjustable hysteresis
- Programmable parameters, password protected
- Compact housing with 320° pivot

Applications

- Marine and off-shore applications
- Steel and heavy industries
- Wind turbines
- Service vehicles

Technical data

| | |
|-----------------------|---|
| Order number | 2340-00000108 |
| Function principle | analogue/digital pressure switch |
| Lubricant | oil, fluid grease and grease up to NLGI 2 |
| Approval | CE, EAC, UL/CSA |
| Operating temperature | -40 to +85 °C; -40 to +185 °F |
| Operating pressure | max. 600 bar; max. 8 700 psi |
| Overload pressure | 1 000 bar; 14 500 psi |
| Burst pressure | 1 570 bar; 22 770 psi |
| Operating voltage | 18-30 VDC |
| Operating current | max. 150 mA |
| Current draw | ≤ 50 mA |
| Output signal | 2x PNP/NPN (NO/NC) adjustable |
| Analogue Output | voltage 0 .. 10 V / current 4 .. 20 mA adjustable |
| Interface | IO-Link 1.1 |
| Switching frequency | 170 Hz |
| Switching cycles | 100 Mio. |
| Material: | |
| Housing | PA6.6, stainless steel 1.4301, FKM |
| Measuring cell | Ceramics Al2O3 |
| Apapter | stainless steel |
| Electrical connection | M12x1; 4-pole, A-coded |
| Pressure port | G1/4 |
| Protection class | IP 67 |
| Dimensions | 95 x 34 x 49 mm 3.74 x 1.33 x 1.92 in |
| Mounting position | any |



NOTE

Further technical information, technical drawings, accessories, spare parts or product function descriptions available on SKF.com/lubrication.

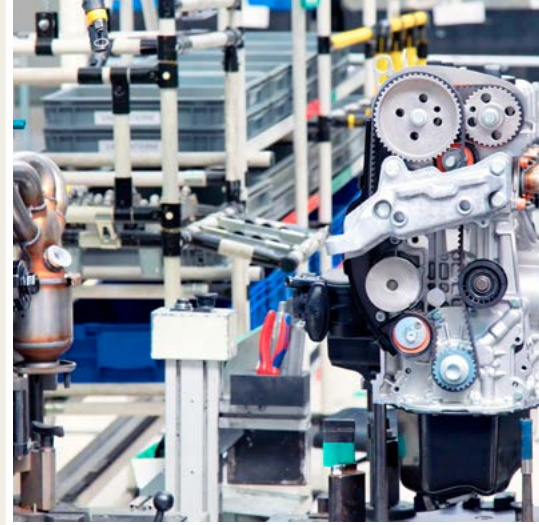

Overview of flow monitors and sensors

Digital flow sensors with digital output signal

| Product | Lubricant | | Function type | Operating temperature | | Voltage | | Page |
|---------|-----------|--------|-------------------------|-----------------------|-------------|---------|-----|------|
| | oil/fluid | grease | | °C | °F | VDC | VAC | |
| GS300 | • | – | Digital oil flow sensor | +10 to +50 | +50 to +122 | 24 | – | 182 |

Hose connection monitor

| Product | Lubricant | | Function type | Operating temperature | | Voltage | | Page |
|---------|-----------|--------|--|-----------------------|-------------|---------|-----|------|
| | oil/fluid | grease | | °C | °F | VDC | VAC | |
| HCC | • | • | Monitoring device for hose connections | -50 to +70 | -58 to +158 | 12/24 | – | 183 |

Flow sensor

GS300

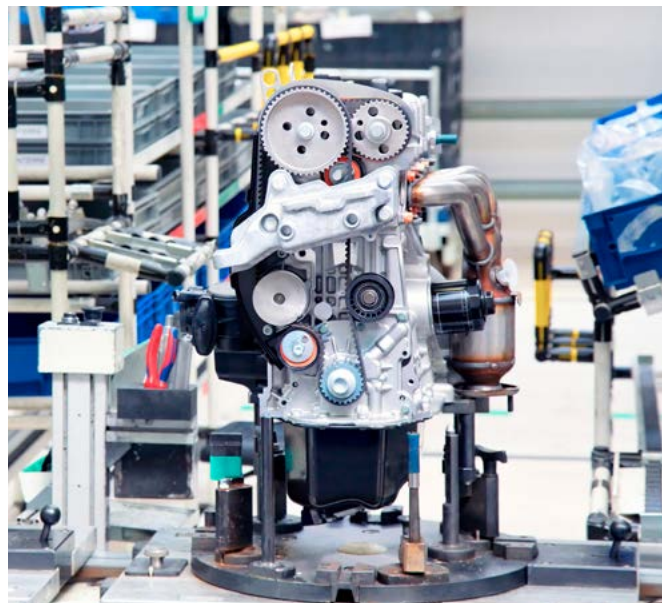

Description

Flow sensors keep an eye on the flow of oil from a metering point to the lubrication point, metering out a small amount of oil for only a short period of time. They are suitable for intermittent, centralized lubrication systems e. g. with piston metering devices, metering elements, injection oilers, oil and air centralized lubrication systems.

Features and benefits

- Provide simple control
- Monitor flow of lubricant from the metering point to the lubrication point
- Meter out a small amount of oil for only a short period of time

Applications

- Machine tools
- Automotive manufacturing
- Industrial assembly and automation

Technical data

| | |
|---------------------------|---|
| Function principle | flow sensor |
| Measuring principle | calorimetric |
| Lubricant 1) | oil (10 to 2 000 mm ² /s) |
| Metering quantity | 0,01 - 0,6 cm ³ /pulse 0.0006 - 0.03 in ³ /pulse |
| Clock frequency 2) | max. 4 pulse/min |
| Operating temperature | +10 to +50 °C, +50 to +122 °F |
| Operating pressure | max. 40 bar; 580 psi |
| Rated voltage | 24 VDC |
| Residual ripple | 10% |
| Working range UA | 18 to 30 VDC |
| Max. power consumption IE | 25 mA |
| Pulse output | 3 s |
| Load current IA for GS300 | max. 10 mA |
| for GS304 | max. 500 mA per output |
| Output protection | short-circuit protection |
| Built-in plug | circular connector with M12x1 screw plug |
| Fluid connection | M 8x1 mm, port tapped for solderless Ø 4 mm tube connection |
| Dimensions | 95 x 50 x 20 mm 3.74 x 1.96 x 0.78 in |
| Mounting position | directly upstream of lubrication point |
| Vibration resistance | 20 g (DIN / IEC 68-2-27, 10-2000 Hz) |
| Impact resistance | 50 g (DIN / IEC 68-2-27, 11 ms) |

¹⁾ Sensor needs 30 sec. of warm-up time

²⁾ The use of oils containing corrosive and/or abrasive additives may impair sensor function and possibly damage the sensor

Order information

Order number Switching function

| | |
|---------------|---|
| GS300 | Pin 1 (BN - brown): + 24 V; Pin 3 (BU - blue): 0 V Pin 4 (BK - black): PNP/NO – closes in event of flow |
| GS304P | Pin 1 (BN - brown): + 24 V Pin 2 (WH - white): PNP/NC – opens in event of flow Pin 3 (BU - blue): 0 V Pin 4 (BK - black): PNP/NO – closes in event of flow |



NOTE

Further technical information, technical drawings, accessories, spare parts or product function descriptions available on SKF.com/lubrication:

1-1704-EN



3D

skf-lubrication.partcommunity.com/3d-cad-models

Hose connection control unit

HCC



Description

The hose connection control (HCC) is intended to monitor electrically conductive, high-pressure lubrication hoses for line breakage. If there is a fault in the main line or feed lines, the unit alerts the machine operator immediately. Operation of the HCC is not affected by line lengths, ambient temperature, pressure differential or pressure losses. Utilizing non-conductive lubricants or hydraulic fluids, this monitoring system has an operating pressure of up to 300 bar (4 350 psi) and can be used in temperatures ranging from -40 to $+70$ °C (-40 to $+158$ °F).

Features and benefits

- Immediately detects hose ruptures
- Expandable at any time
- Easy retrofit in existing lubrication systems
- Monitors difficult-to-access hoses to lubrication points
- Common LED signal of all connected hoses on the display

Applications

- Construction and mining machines; cranes, forklifts
- Wood-handling and agriculture machine



NOTE

Further technical information, technical drawings, accessories, spare parts or product function descriptions available on SKF.com/lubrication:

16966 EN, 951-170-232

Technical data

| | |
|---------------------------------------|--|
| Function principle | control and monitoring device for hose connections |
| Operating temperature | Isolator: -50 to $+70$ °C; -58 to $+158$ °F Controller: -25 to $+70$ °C; -13 to $+158$ °F Controller storage: -40 to $+70$ °C; -40 to $+158$ °F |
| Power supply | 12/24 V DC |
| Monitored hose per monitoring unit | max. 15 pieces at 12 V DC max. 24 pieces at 24 V DC |
| Positive ok signal | 12/24 V PNP |
| Signal cable to one cut-off connector | 20 m; 65 ft |
| Signal cable at cut-off | approx. 150 mm; 5.90 in |
| Protection class | IP 65 |
| Dimensions | 100 × 85 × 40 mm 3.93 × 3.34 × 1.57 in |

Order information

| Order number | Designation |
|--------------------|---|
| 236-10986-1 | HCC, evaluation unit |
| 236-10153-3 | HCC, with cable 20 m |
| 532-34839-2 | HCC, endlink HCC DN 8-10L-E |
| 532-37731-1 | basic kit consisting of above three parts |
| 532-34839-6 | HCC, endlink HCC DN 4-6L-E |
| 532-34839-3 | HCC, interlink HCC DN 8-10L-I |
| 532-34839-5 | HCC, Interlink HCC DN 4-6L-I |

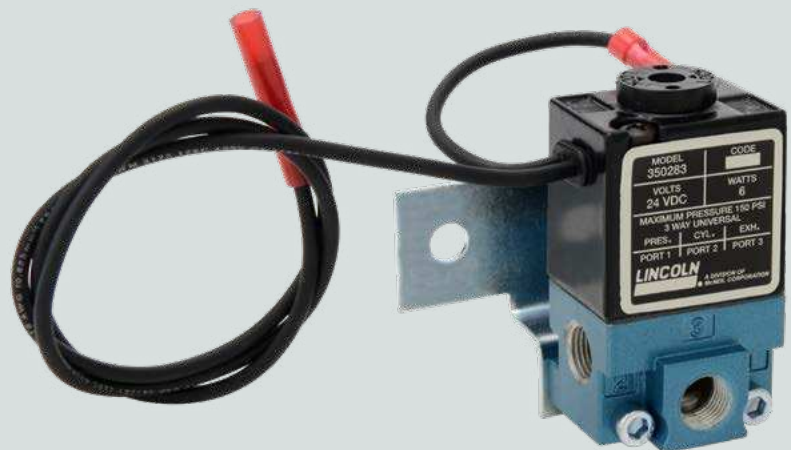

Overview of solenoid valves

| Solenoid valves | | | | | | | | |
|--------------------|--------------------------|-------------------------|--------|-----------------------------|-------------|---------|---------|------|
| Product | Type | Operating pressure max. | | Operating temperature range | | Voltage | | Page |
| | | bar | psi | °C | °F | VDC | VAC | |
| Air valves | | | | | | | | |
| 350241 | 3-way air valve | 10,3 | 150 | -18 to +60 | 0 to 140 | – | 110–240 | 186 |
| 350242 | 3-way air valve | 10,3 | 150 | -18 to +60 | 0 to 140 | – | 110–240 | 186 |
| 350244 | 4-way air valve | 10,3 | 150 | -18 to +49 | 0 to 120 | – | 110–240 | 186 |
| 350245 | 4-way air valve | 10,3 | 150 | -18 to +49 | 0 to 120 | – | 110–240 | 186 |
| 350282 | 3-way air valve | 10,3 | 150 | -18 to +60 | 0 to 140 | 12 | – | 187 |
| 350283 | 3-way air valve | 10,3 | 150 | -18 to +60 | 0 to 140 | 24 | – | 187 |
| 253-14076-6 | 3/2-way air valve | 16 | 232 | -10 to +55 | 14 to 131 | – | 110 | 188 |
| 253-14076-7 | 3/2-way air valve | 16 | 232 | -10 to +55 | 14 to 131 | – | 230 | 188 |
| Lubricant valves | | | | | | | | |
| 12375740 | 2/2-way oil/grease valve | 300 | 4 351 | -10 to +50 | +14 to 122 | 24 | – | 189 |
| 12375745 | 2/2-way oil/grease valve | 300 | 4 351 | -10 to +50 | +14 to 122 | 24 | – | 189 |
| 12375750 | 2/2-way oil/grease valve | 300 | 4 351 | -10 to +50 | +14 to 122 | – | 110 | 189 |
| 12375755 | 2/2-way oil/grease valve | 300 | 4 351 | -10 to +50 | +14 to 122 | – | 230 | 189 |
| 12375760 | 2/2-way oil/grease valve | 300 | 4 351 | -10 to +50 | +14 to 122 | 24 | – | 189 |
| 12375765 | 2/2-way oil/grease valve | 300 | 4 351 | -10 to +50 | +14 to 122 | 24 | – | 189 |
| 12375770 | 2/2-way oil/grease valve | 300 | 4 351 | -10 to +50 | +14 to 122 | – | 110 | 189 |
| 12375775 | 2/2-way oil/grease valve | 300 | 4 351 | -10 to +50 | +14 to 122 | – | 230 | 189 |
| 12375460 | 3/2-way oil/grease valve | 300 | 4 351 | -10 to +50 | +14 to 122 | 24 | – | 190 |
| 12375465 | 3/2-way oil/grease valve | 300 | 4 351 | -10 to +50 | +14 to 122 | 24 | – | 190 |
| 12375461 | 3/2-way oil/grease valve | 300 | 4 351 | -10 to +50 | +14 to 122 | – | 110 | 190 |
| 12375466 | 3/2-way oil/grease valve | 300 | 4 351 | -10 to +50 | +14 to 122 | – | 110 | 190 |
| 525-32080-1 | 2/2-way oil/grease valve | 400 | 5 800 | -20 to +60 | -4 to +140 | 24 | – | 191 |
| 525-32081-1 | 2/2-way oil/grease valve | 400 | 5 800 | -20 to +60 | -4 to +140 | – | 110 | 191 |
| 525-32082-1 | 2/2-way oil/grease valve | 400 | 5 800 | -20 to +60 | -4 to +140 | – | 230 | 191 |
| 525-32083-1 | 2/2-way oil/grease valve | 400 | 5 800 | -20 to +60 | -4 to +140 | 24 | – | 191 |
| 525-32098-1 | 2/2-way oil/grease valve | 400 | 5 800 | -20 to +60 | -4 to +140 | – | 110 | 191 |
| 525-32084-1 | 2/2-way oil/grease valve | 400 | 5 800 | -20 to +60 | -4 to +140 | – | 230 | 191 |
| 525-32085-1 | 3/2-way oil/grease valve | 400 | 5 800 | -20 to +60 | -4 to +140 | 24 | – | 191 |
| 525-32086-1 | 3/2-way oil/grease valve | 400 | 5 800 | -20 to +60 | -4 to +140 | – | 110 | 191 |
| 525-32087-1 | 3/2-way oil/grease valve | 400 | 5 800 | -20 to +60 | -4 to +140 | – | 230 | 191 |
| 161-110-031 | 2/2-way oil/grease valve | 500 | 7 250 | -25 to +80 | -13 to +176 | 24 | – | 192 |
| 525-60463-1 | 2/2-way oil/grease valve | 700 | 10 150 | -40 to +80 | -40 to +176 | 24 | – | 193 |
| 525-60464-1 | 2/2-way oil/grease valve | 700 | 10 150 | -40 to +80 | -40 to +176 | – | 110 | 193 |
| 525-60465-1 | 2/2-way oil/grease valve | 700 | 10 150 | -40 to +80 | -40 to +176 | – | 230 | 193 |
| 525-60466-1 | 2/2-way oil/grease valve | 700 | 10 150 | -40 to +80 | -40 to +176 | 24 | – | 193 |
| 525-60467-1 | 2/2-way oil/grease valve | 700 | 10 150 | -40 to +80 | -40 to +176 | – | 110 | 193 |
| 525-60468-1 | 2/2-way oil/grease valve | 700 | 10 150 | -40 to +80 | -40 to +176 | – | 230 | 193 |
| 525-60469-1 | 3/2-way oil/grease valve | 700 | 10 150 | -40 to +80 | -40 to +176 | 24 | – | 193 |
| 525-60470-1 | 3/2-way oil/grease valve | 700 | 10 150 | -40 to +80 | -40 to +176 | – | 110 | 193 |
| 525-60471-1 | 3/2-way oil/grease valve | 700 | 10 150 | -40 to +80 | -40 to +176 | – | 230 | 193 |
| 161-140-050 | 4/2-way oil/grease valve | 320 | 4 350 | -25 to +80 | -13 to +176 | 24 | 220 | 194 |

Solenoid valve

35024 ...



Description

Electric solenoid-operated air valves 350241 to 350245 operate as 3-way or 4-way solenoid air valves. They are used to operate single-stroke or reciprocating-stroke, air-controlled pumps in single-line systems. Timer- and pressure-controlled air is supplied to the pumps, activating air-powered forward strokes and spring- (3-way) or air-powered (4-way) return strokes. In doing so, pumps discharge lubricant to the connected metering devices.

Features and benefits

- Timer- and pressure-controlled pump operation
- Use as 3-way or 4-way solenoid valves
- For operation of single-stroke or reciprocating-stroke pumps
- Flexible usage selectable on electrical VAC power requirements

Applications

- Mining and mineral processing
- Heavy machines

Technical data

| | | |
|-----------------------|------------------------------------|--|
| Function principle | | |
| Model 350241, 350242 | 3-way, solenoid-operated air valve | |
| Model 350244, 350245 | 4-way, solenoid-operated air valve | |
| Operating temperature | | |
| Model 350241, 350242 | -18 to +60 °C, 0 to +140 °F | |
| Model 350244, 350245 | -18 to +49 °C, 0 to +120 °F | |
| Operating pressure | max. 10 bar; 150 psi | |
| Operating voltage | 110–240 VAC | |
| Current | 8,4 A | |
| Current inrush | | |
| Model 350241, 350244 | 0,11 A | |
| Model 350242, 350245 | 0,055 A | |
| Current holding | | |
| Model 350241, 350244 | 0,7 A | |
| Model 350242, 350245 | 0,35 A | |
| Air inlet/outlet | 1/4 NPT (F) | |
| Conduit connection | 1/2 NPS (F) | |
| Mounting position | any | |

Order information

| Order number | Designation | Type |
|--------------|--|-------|
| 350241 | 110 VAC, 50 Hz, 120 VAC, 60 Hz, 8,4 VA | 3-way |
| 350242 | 220 VAC, 50 Hz, 240 VAC, 60 Hz, 8,4 VA | 3-way |
| 350244 | 110 VAC, 50 Hz, 120 VAC, 60 Hz, 8,4 VA | 4-way |
| 350245 | 220 VAC, 50 Hz, 240 VAC, 60 Hz, 8,4 VA | 4-way |



NOTE

Further technical information, technical drawings, accessories, spare parts or product function descriptions available on SKF.com/lubrication.

Solenoid valve

350282, 350283

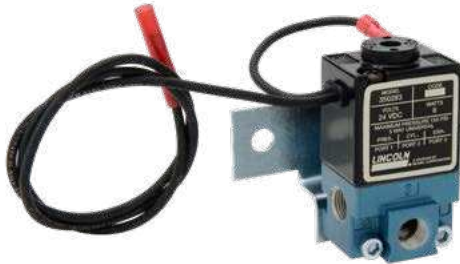

Description

Electric solenoid-operated air valves 350282 and 350283 operate as DC 3-way solenoid air valves. They are used to operate single-stroke, air-controlled pumps in single-line systems. Timer- and pressure-controlled air is supplied to the pumps, activating air-powered forward strokes and spring- (3-way) return strokes. In doing so, pumps discharge lubricant to the connected metering devices.

Features and benefits

- Timer- and pressure-controlled pump operation
- Use as 3-way solenoid valves
- For operation of single-stroke pumps
- Flexible usage selectable on electrical 12 or 24 VDC power requirements

Applications

- Mining and mineral processing
- Heavy machines

Technical data

| | |
|-----------------------|--------------------------------|
| Order number | 350282 350283 |
| Function principle | 3-way solenoid air valve |
| Voltage supply: | |
| Model 350282 | 12 VDC, 6 VA |
| Model 350283 | 24 VDC, 6 VA |
| Operating temperature | -18 to +60 °C, 0 to +140 °F |
| Operating pressure . | max. 10 bar; 150 psi |
| Air inlet/outlet | 1/8 NPT (F) |
| Cv factor | 0.18 |
| Mounting position | any |



NOTE

Further technical information, technical drawings, accessories, spare parts or product function descriptions available on SKF.com/lubrication:

442832

Solenoid valve

253-14076-X



Description

Pumps in single-line systems can be supplied and actuated with compressed air via servo-controlled, 3/2-way piston valves (magnetic valve). For function and operation of the valve, a minimum differential pressure of 0,5 bar is requested. The valve is equipped with a control for initiation and check of function. Currentless, the valve is open to outlet A. It has a smooth-running servo piston. A 3/2-way pilot valve (tilting armature valve) provides safe and reliable operation.

Features and benefits

- Simple to install; no extra parts required
- Service friendly manual control of function
- Medium, separated pilot valve for higher operational safety
- Ground-optimized piston design for low switching pressure
- Power-saving pulse inductor

Applications

- Conveyors, transportation systems
- Chain lubrication
- Spray systems

Technical data

| | |
|-----------------------|---|
| Function principle | 3/2-way solenoid air valve with servo piston |
| Initial state | outlet A open |
| Operating temperature | -10 to +55 °C +14 to +131 °F |
| Operating pressure | 0,5–16 bar; 7,3–232 psi |
| Supply voltage | Model 253-14076-6 110 VAC, 50 Hz Model 253-14076-7 230 VAC, 50–60 Hz |
| Power consumption | 8 W |
| Protection class | IP 65 |
| Air inlet | G 1/2 |
| Air return connection | G 3/4 |
| Nominal width | 12 mm; 8.35 in, socket |
| Materials | brass, NBR |
| Output connection | socket for cable Ø 7 mm Ø 0.28 in |
| Dimensions | 179,5 × 76 × 33 mm 7.06 × 3 × 1.3 in |
| Mounting position | any, especially impulse upward |

Order information

| Order number | Type | Operating voltage | Connection thread BSPP (F) |
|--------------|---------------|-------------------|----------------------------|
| 253-14076-6 | 3/2-way valve | 110–120 VAC | G 1/2 |
| 253-14076-7 | 3/2-way valve | 230 VAC | G 1/2 |



NOTE

Further technical information, technical drawings, accessories, spare parts or product function descriptions available on SKF.com/lubrication:

Solenoid valve

E-VALV-S



Description

The E-VALV-S shut-off valve can be used to operate independent lubrication zones in larger lubrication systems. E-VALV-S valves have integrated check valves and electrical NC or NO actuation for low or high voltage. They can be connected to the lubrication system controller or directly to the controller of the lubricated machines.

Features and benefits

- Easy to use and simple to install
- Electrically driven, requires no pressurized air
- Optimized lubricant consumption, only running machines are lubricated

Applications

- Steel industry
- General industry
- Pulp and Paper industry
- Food and beverage industry
- Mining and cement industry

Technical data

| | |
|-------------------------|--|
| Function principle | electrically operated (2/2-way) shut-off valve |
| Operating temperature | -10 to +50 °C, +14 to +122 °F |
| Lubricant | grease up to NLGI 2 |
| Operating pressure | max. 300 bar; 4351 psi |
| Operating voltage | 24 V DC, 110 and 230 VAC |
| Inlet/outlet connection | 12 mm or 1/2 in pipe connection |
| Protection class | IP 67 |
| Dimensions | 123 × 90 × 200 mm 4.84 × 3.54 × 7.87 in |
| Mounting position | any |

Order information

| Order number | Designation | Lubricant line Ø | Voltage |
|--------------|--------------------|------------------|---------|
| 12375740 | E-VALV-S1-NC-24 | 12 mm | 24 V DC |
| 12375745 | E-VALV-S1-NC-24-U | 1/2 in | 24 V DC |
| 12375750 | E-VALV-S1-NC-110-U | 1/2 in | 110 VAC |
| 12375755 | E-VALV-S1-NC-230 | 12 mm | 230 VAC |
| 12375760 | E-VALV-S1-NO-24 | 12 mm | 24 V DC |
| 12375765 | E-VALV-S1-NO-24-U | 1/2 in | 24 V DC |
| 12375770 | E-VALV-S1-NO-110-U | 1/2 in | 110 VAC |
| 12375775 | E-VALV-S1-NO-230 | 12 mm | 230 VAC |



NOTE

Further technical information, technical drawings, accessories, spare parts or product function descriptions available on SKF.com/lubrication:

Solenoid valve

E-VALV-L



Description

The electrically operated E-VALV-L is a modular 3/2 ways change-over valve where each module has an internal pressure and reservoir port. The advantage of the change-over function is that the pressurized line can be easily vented and thus the next line can be pressurized quickly. The modular design enables up to 5 independent lubrication zones for single-line or progressive systems. Grease filters and barrel pump supports are available as accessories.

Features and benefits

- Easy to use and simple to install due modular design
- Electrically driven and shall not require pressurized air
- Better system venting enabling frequent relubrication

Applications

- Steel industry
- General industry
- Pulp and Paper industry
- Food and beverage industry
- Mining and cement industry

Technical data

| | |
|-------------------------|--|
| Function principle | electrically operated (3/2-way) change-over valve |
| Operating temperature | -10 to +50 °C, +14 to +122 °F |
| Lubricant | grease up to NLGI 2 |
| Operating pressure | max. 300 bar; 4351 psi |
| Operating voltage | 24 V DC, 110 V AC |
| Inlet/outlet connection | 12 mm or 1/2 in pipe connection |
| Protection class | IP 67 |
| Dimensions | min. 59 × 100 × 230 mm min. 2.32 × 3.93 × 9.05 in |
| Mounting position | any |

Order information

| Order number | Designation | Description | Voltage |
|--------------|------------------|---------------------------|----------|
| 12375460 | E-VALV-L1-24 | Change-over valve L1 | 24 V DC |
| 12375465 | E-VALV-L1-24-U | Change-over valve L1 (US) | 24 V DC |
| 12375461 | E-VALV-L1-110V | Change-over valve L1 | 110 V AC |
| 12375466 | E-VALV-L1-110V-U | Change-over valve L1 (US) | 110 V AC |



NOTE

Further technical information, technical drawings, accessories, spare parts or product function descriptions available on SKF.com/lubrication.

Solenoid valve

525-320XX-1



Description

525-320XX-1 are 2/2 and 3/2-way solenoid valves suitable to supply lubricant in different lubrication circuits. Each lubrication circuit can be connected to one pump outlet by switching off or switching on separately. Thereby, the pressure inlet is connected either to one or to the other circuit. Solenoid valves are equipped with a dry magnetic rotor and a conical seat valve. In their initial state, the valves always are open to the return line and are activated by a return spring. The current switching positions remain as long as current is switched on. 525-320XX-1 solenoid valves are switchable and suitable for bidirectional flows. These valves can also be used as release valves.

Features and benefits

- Suitable for bidirectional flow operation
- Suitable to divide lubricant in different lubrication circuits on different time sequences
- Cone-seated solenoid valve with dry actuation
- Switchable and resistant to compression in both flow directions

Applications

- Construction machinery
- Wind turbines
- Mining



NOTE

Further technical information, technical drawings, accessories, spare parts or product function descriptions available on SKF.com/lubrication:



Technical data

| | |
|-----------------------|--|
| Function principle | 2/2 or 3/2-way solenoid valves |
| Lubricant | oil, fluid grease and grease NLGI 0, 1, 2 |
| Operating temperature | -40 to +70 °C; -40 to +158 °F |
| Operating pressure | 0-400 bar; 0-5 800 psi |
| Flow rate | max. 2 400 cm ³ /min max. 146.5 in ³ /min |
| Supply voltage | 24 VDC, 110 VAC, 50 Hz 230 VAC, 50-60 Hz |
| Current draw | 0,83 A; 0,2 A; 0,1 A |
| Rated power | 20 W |
| Pressure connection | G 1/2 or G 3/8 |
| Protection class | IP 54 |
| Isolation class | F |
| Materials | steel, aluminum |
| Dimensions | 147 × 50 × 45 mm 5.78 × 1.96 × 1.77 in |
| Mounting position | any |

Order information

| Order number | Designation | Closed circuit current | Valve type | Operating voltage |
|--------------|--------------------|------------------------|------------|-------------------|
| 525-32080-1 | WV-M-W2G-1/2- 24DC | closed | 2/2 | 24 VDC |
| 525-32081-1 | WV-M-W2G-1/2-110AC | closed | 2/2 | 110 VAC |
| 525-32082-1 | WV-M-W2G-1/2-230AC | closed | 2/2 | 230 VAC |
| 525-32083-1 | WV-M-W20-1/2- 24DC | open | 2/2 | 24 VDC |
| 525-32098-1 | WV-M-W20-1/2-110AC | open | 2/2 | 110 VAC |
| 525-32084-1 | WV-M-W20-1/2-230AC | open | 2/2 | 230 VAC |
| 525-32085-1 | WV-M-W3 -3/8- 24DC | n.a. | 3/2 | 24 VDC |
| 525-32086-1 | WV-M-W3 -3/8-110AC | n.a. | 3/2 | 110 VAC |
| 525-32087-1 | WV-M-W3 -3/8-230AC | n.a. | 3/2 | 230 VAC |

Solenoid valve

161-110-031



Description

The directional valves are used to control the flow of lubricants, e.g. to divide up a central lubrication system into a number of lubrication circuits (zoned actuation) or to switch between circulating and intermittently operated lubrication circuits. Valves for a maximum pressure of up to 45 bar can be used for single-line lubrication systems with metering devices. Valves for a pressure range of up to 300 or 500 bar also are suitable for progressive systems.

Features and benefits

- Directional valves for oil with a low or high effective viscosity and greases up to NLGI Grade 2
- 2-, 4- or 5-way valve switching functions selectable for zoned actuations
- For single-line systems with sectional supplying of lubricants dependent upon different times and quantities
- Manual action possible

Applications

- Paper industry
- Steel industry
- Heavy industry

Technical data

| | |
|--------------------------------|---|
| Order number | 161-110-031 |
| Function principle | 2/2-way solenoid valve |
| Lubricant | oil and grease up to NLGI 2 |
| Operating temperatures: | |
| Oil, 4–1 500 mm/s ² | –40 to +80 °C; –40 to +176 °F |
| Grease, 700 mbar | –25 to +80 °C; –13 to +176 °F |
| Operating pressure | max. 500 bar, max. 7 250 psi |
| Hydraulic connector | G1/4 |
| Materials | aluminum |
| Supply voltage | 24 VDC |
| Rated current | 0,67 A |
| Rated power | 16 W, 5 W |
| Electrical connection | DIN EN175301-803 |
| Protection class | IP 65 with plug |
| Dimensions | 146,5 × 55 × 45 mm 5,77 × 2,17 × 1,77 in |
| Mounting position | any |
| Dimensions | 179,5 × 76 × 33 mm 7,06 × 3 × 1,3 in |



NOTE

Further technical information, technical drawings, accessories, spare parts or product function descriptions available on SKF.com/lubrication: |

1-1703-EN

Solenoid valve

525-604XX-1



Description

525-604XX-1 are 2/2 and 3/2-way solenoid valves suitable to supply lubricant in different lubrication circuits. Each lubrication circuit can be connected to one pump outlet by switching off or switching on separately. Thereby, the pressure inlet is connected either to one or to the other circuit. Solenoid valves are equipped with a dry magnetic rotor and a conical seat valve. In their initial state, the valves are always open to the return line and activated by a return spring. The current switching positions remain as long as current is switched on. 525-604XX-1 solenoid valves are switchable and suitable for bidirectional flows. These valves can also be used as release valves.

Features and benefits

- Suitable for bidirectional flow operation
- Suitable to divide lubricant in different lubrication circuits on different time sequences
- Cone-seated solenoid valve with dry actuation
- Switchable and resistant to compression in both flow directions

Applications

- Construction machinery
- Wind turbines
- Mining



NOTE

Further technical information, technical drawings, accessories, spare parts or product function descriptions available on SKF.com/lubrication:

Technical data

| | |
|-----------------------|--|
| Function principle | 2/2 or 3/2-way solenoid valves |
| Initial state | outlet B to R is open |
| Lubricant | oil, fluid grease and grease NLGI 0, 1, 2 |
| Operating temperature | -40 to +80 °C; -40 to +176 °F |
| Operating pressure | 0-700 bar; 0-10 150 psi |
| Flow rate | max. 2 400 cm ³ /min max. 146.5 in ³ /min |
| Supply voltage | 24 VDC, 110 VAC, 50 Hz 230 VAC, 50-60 Hz |
| Current draw | 0,83 A; 0,2 A; 0,1 A |
| Rated power | 20 W |
| Pressure connection | G 1/2 or G 3/8 |
| Protection class | IP 65 |
| Isolation class | F |
| Materials | steel, aluminum |
| Dimensions | 147 × 50 × 45 mm 5.78 × 1.96 × 1.77 in |
| Mounting position | any |

Order information

| Order number | Designation | Closed circuit current | Valve type | Operating voltage |
|--------------|-----------------------|------------------------|------------|-------------------|
| 525-60463-1 | WV-M-W2G-1/2- 24DC-BI | closed | 2/2 | 24 VDC |
| 525-60464-1 | WV-M-W2G-1/2-110AC-BI | closed | 2/2 | 110 VAC |
| 525-60465-1 | WV-M-W2G-1/2-230AC-BI | closed | 2/2 | 230 VAC |
| 525-60466-1 | WV-M-W20-1/2- 24DC-BI | open | 2/2 | 24 VDC |
| 525-60467-1 | WV-M-W20-1/2-110AC-BI | open | 2/2 | 110 VAC |
| 525-60468-1 | WV-M-W20-1/2-230AC-BI | open | 2/2 | 230 VAC |
| 525-60469-1 | WV-M-W3 -3/8- 24DC-BI | n.a. | 3/2 | 24 VDC |
| 525-60470-1 | WV-M-W3 -3/8-110AC-BI | n.a. | 3/2 | 110 VAC |
| 525-60471-1 | WV-M-W3 -3/8-230AC-BI | n.a. | 3/2 | 230 VAC |

Solenoid valve

161-140-050



Description

These directional valves are used to control the flow of lubricants, e.g. to divide up a central lubrication system into a number of lubrication circuits (zoned actuation) or to switch between circulating and intermittently operated lubrication circuits. Valves for a maximum pressure of up to 45 bar can be used for single-line lubrication systems with metering devices. Valves for a pressure range of up to 300 or 500 bar also are suitable for progressive systems.

Features and benefits

- Directional valves for oil with a low or high effective viscosity and greases up to NLGI Grade 2
- 2-, 4- or 5-way valve switching functions selectable for zoned actuations
- For single-line systems with sectional supplying of lubricants dependent upon different times and quantities
- Manual action possible

Applications

- Paper industry
- Steel industry
- Heavy industry

Technical data

| | |
|---------------------------------|--|
| Order number | 161-140-050 |
| Function principle | 4/2-way valve |
| Lubricant | oil and grease up to NLGI 2 |
| Valve, basic position | sliding, open P to A |
| Operating temperatures: | |
| oil, 4-1 500 mm ² /s | -40 to +80 °C; -40 to +176 °F |
| grease, 700 mbar | -25 to +80 °C; -13 to +176 °F |
| Operating pressure | max. 320 bar; max. 4 350 psi |
| Hydraulic connector | base plate G 1/4 |
| Materials | aluminum |
| Supply voltage | DC and AC |
| Rated current | 1,33 A at 24 VDC; 0,17 A at 220 V AC, 50 Hz |
| Rated power | 16 W, 5 W |
| Electrical connection | DIN EN175301-803 |
| Protection class | IP 65 with plug |
| Dimensions | 148 x 58 x 45 mm 5.83 x 2.28 x 1.77 in |
| Mounting position | any |



NOTE

Further technical information, technical drawings, accessories, spare parts or product function descriptions available on SKF.com/lubrication:

1-1703-EN

Index

| | | | | | | | |
|------------------------|-----|-------------------|-----|---------------------|-----|---------------------|-----|
| 161-110-031..... | 192 | 321-403G1..... | 105 | 321-606G1..... | 105 | 352-020-S8-VS..... | 97 |
| 161-120-067+924..... | 27 | 321-403G2..... | 105 | 321-606G2..... | 105 | 352-020-S82-VS..... | 97 |
| 161-140-050..... | 194 | 321-403G3..... | 105 | 321-606G3..... | 105 | 352-020-VS..... | 97 |
| 169-400-405..... | 27 | 321-403G4..... | 105 | 321-606T2..... | 105 | 352-030-K-S82..... | 97 |
| 179-990-033/ -147..... | 33 | 321-403G7..... | 105 | 321-606T3..... | 105 | 352-030-S82-VS..... | 97 |
| 179-990-371/ -381..... | 33 | 321-403G7-S8..... | 105 | 321-606W1..... | 105 | 352-040-K..... | 97 |
| 179-990-372/ -382..... | 33 | 321-403T1..... | 105 | 321-606W2..... | 105 | 352-040-K-S8..... | 97 |
| 223-12289-7..... | 135 | 321-403T2..... | 105 | 321-606W3..... | 105 | 352-040-S8-VS..... | 97 |
| 234-10330-4..... | 176 | 321-403T3..... | 105 | 321-610G1..... | 105 | 352-040-VS..... | 97 |
| 234-11272-4..... | 177 | 321-403W1..... | 105 | 321-610G2..... | 105 | 352-060-K..... | 97 |
| 234-13161-5..... | 178 | 321-403W2..... | 105 | 321-610G3..... | 105 | 352-060-K-S8..... | 97 |
| 234-13161-9..... | 174 | 321-403W3..... | 105 | 321-610G7..... | 105 | 352-060-S8-VS..... | 97 |
| 236-10153-3..... | 183 | 321-406G1..... | 105 | 321-610T1..... | 105 | 352-060-VS..... | 97 |
| 236-10567-5..... | 159 | 321-406G2..... | 105 | 321-610T2..... | 105 | 391-010-K-S1..... | 103 |
| 236-10567-6..... | 159 | 321-406G3..... | 105 | 321-610T3..... | 105 | 391-020-K..... | 103 |
| 236-10850-7..... | 161 | 321-406G4..... | 105 | 321-610W1..... | 105 | 391-020-K-S1..... | 103 |
| 236-10850-8..... | 161 | 321-406G7..... | 105 | 321-610W2..... | 105 | 391-020-K-S8..... | 103 |
| 236-10850-9..... | 161 | 321-406G7-S8..... | 105 | 321-610W3..... | 105 | 391-030-K-S1..... | 103 |
| 236-10980-2..... | 154 | 321-406T1..... | 105 | 321-616G7..... | 105 | 391-040-K..... | 103 |
| 236-10980-2..... | 155 | 321-406T3..... | 105 | 321-620G7..... | 105 | 391-040-K-S8..... | 103 |
| 236-10980-2..... | 159 | 321-406W1..... | 105 | 321-630G7..... | 105 | 391-060-K..... | 103 |
| 236-10980-2..... | 161 | 321-406W2..... | 105 | 341-453-K-S8..... | 89 | 391-060-K-S8..... | 103 |
| 236-10980-4..... | 154 | 321-406W3..... | 105 | 341-453-S8-VS..... | 89 | 391-100-K..... | 103 |
| 236-10980-4..... | 155 | 321-410G1..... | 105 | 341-456-K-S8..... | 89 | 391-100-K-S8..... | 103 |
| 236-10980-4..... | 159 | 321-410G2..... | 105 | 341-456-S8-VS..... | 89 | 391-150-K..... | 103 |
| 236-10980-4..... | 161 | 321-410G3..... | 105 | 341-460-K-S8..... | 89 | 391-150-K-S8..... | 103 |
| 236-10980-6..... | 159 | 321-410G4..... | 105 | 341-460-S8-VS..... | 89 | 406-004-VS..... | 27 |
| 236-10980-6..... | 161 | 321-410G7..... | 105 | 341-466-K-S8..... | 89 | 406-004-VS..... | 33 |
| 236-10980-6..... | 161 | 321-410G7-S8..... | 105 | 341-466-S8-VS..... | 89 | 408-004-VS..... | 27 |
| 236-10980-7..... | 159 | 321-410T1..... | 105 | 341-853-K..... | 89 | 408-004-VS..... | 33 |
| 236-10980-7..... | 161 | 321-410T2..... | 105 | 341-853-VS..... | 89 | 447-71899-1..... | 111 |
| 236-10980-8..... | 159 | 321-410T3..... | 105 | 341-856-K..... | 89 | 447-71901-1..... | 111 |
| 236-10980-8..... | 161 | 321-410W1..... | 105 | 341-856-VS..... | 89 | 447-71902-1..... | 111 |
| 236-10980-9..... | 159 | 321-410W2..... | 105 | 341-860-K..... | 89 | 447-71903-1..... | 111 |
| 236-10980-9..... | 161 | 321-410W3..... | 105 | 341-860-VS..... | 89 | 447-71904-1..... | 111 |
| 236-10986-1..... | 183 | 321-601G1..... | 105 | 352-005-K..... | 97 | 447-71905-1..... | 111 |
| 236-11066-1..... | 161 | 321-601G2..... | 105 | 352-005-K-S8..... | 97 | 447-71906-1..... | 111 |
| 237-11204-8..... | 63 | 321-601W2..... | 105 | 352-005-S8-VS..... | 97 | 451-006-060..... | 33 |
| 253-14076-6..... | 188 | 321-601W3..... | 105 | 352-005-VS..... | 97 | 451-008-060..... | 33 |
| 253-14076-7..... | 188 | 321-603G1..... | 105 | 352-010-K..... | 97 | 454-71505-1..... | 135 |
| 321-101..... | 105 | 321-603G2..... | 105 | 352-010-K-S8..... | 97 | 454-71506-1..... | 135 |
| 321-103..... | 105 | 321-603G3..... | 105 | 352-010-K-S82..... | 97 | 454-71507-1..... | 135 |
| 321-401G1..... | 105 | 321-603T1..... | 105 | 352-010-S8-VS..... | 97 | 454-71508-1..... | 135 |
| 321-401G2..... | 105 | 321-603T2..... | 105 | 352-010-S82-VS..... | 97 | 454-71509-1..... | 135 |
| 321-401G3..... | 105 | 321-603T3..... | 105 | 352-010-VS..... | 97 | 466-431-001..... | 27 |
| 321-401G7..... | 105 | 321-603W1..... | 105 | 352-020-K..... | 97 | 466-431-001..... | 33 |
| 321-401T2..... | 105 | 321-603W2..... | 105 | 352-020-K-S8..... | 97 | 501-301-011..... | 20 |
| 321-401W2..... | 105 | 321-603W3..... | 105 | 352-020-K-S82..... | 97 | 501-301-024-VS..... | 20 |

Index

| | | | | | | | |
|----------------|-----|----------------|-----|---------------|-----|---------|-----|
| 501-303-011 | 20 | 645-41325-4 | 77 | 2340-00000108 | 179 | 80086 | 77 |
| 501-303-024-VS | 20 | 645-41370-1 | 35 | 2340-00000118 | 175 | 80087 | 77 |
| 506-140-VS | 27 | 645-41370-2 | 35 | 2350-00000077 | 59 | 80088 | 77 |
| 506-140-VS | 33 | 645-41370-3 | 35 | 3515-07-2022 | 161 | 80089 | 77 |
| 525-32080-1 | 191 | 645-77196-1 | 69 | 3515-07-6120 | 161 | 80090 | 77 |
| 525-32081-1 | 191 | 645-77196-1 | 77 | 3515-10-2021 | 161 | 80091 | 77 |
| 525-32082-1 | 191 | 645-77625-1 | 69 | 3515-10-6020 | 161 | 80105 | 77 |
| 525-32083-1 | 83 | 645-77625-1 | 77 | 3515-10-6120 | 161 | 80106 | 77 |
| 525-32083-1 | 191 | 647-41151-2 | 111 | 3515-10-6320 | 161 | 80107 | 77 |
| 525-32084-1 | 191 | 647-41152-2 | 111 | 3515-10-6620 | 161 | 80108 | 77 |
| 525-32085-1 | 191 | 647-41152-4 | 111 | 3515-10-7620 | 161 | 80109 | 77 |
| 525-32086-1 | 191 | 647-41153-2 | 111 | 4090-00000011 | 59 | 80111 | 77 |
| 525-32087-1 | 191 | 647-41154-4 | 111 | 5090-00000001 | 59 | 80112 | 77 |
| 525-32098-1 | 191 | 647-41154-5 | 111 | 5090-00000005 | 59 | 80120 | 77 |
| 525-60463-1 | 193 | 647-41154-6 | 111 | 5090-00000011 | 59 | 80121 | 77 |
| 525-60464-1 | 193 | 647-41154-7 | 111 | 5090-00000012 | 59 | 80122 | 77 |
| 525-60465-1 | 193 | 647-41155-2 | 111 | 5090-00000013 | 59 | 80127 | 35 |
| 525-60466-1 | 193 | 647-41156-2 | 111 | 6450-00000029 | 35 | 80128 | 35 |
| 525-60467-1 | 193 | 664-34135-6 | 155 | 6640-00000046 | 59 | 80134 | 77 |
| 525-60468-1 | 193 | 664-34135-7 | 155 | 6640-00000064 | 59 | 80135 | 77 |
| 525-60469-1 | 193 | 898-110-120 | 33 | 6640-00000065 | 59 | 81770-1 | 133 |
| 525-60470-1 | 193 | 898-210-001 | 93 | 11962 | 117 | 81770-2 | 133 |
| 525-60471-1 | 193 | 995-901-061 | 27 | 11962 | 119 | 81770-3 | 133 |
| 532-34839-2 | 183 | 995-901-063 | 27 | 11963 | 117 | 81770-4 | 133 |
| 532-34839-3 | 183 | 995-993-610 | 97 | 11963 | 119 | 81770-5 | 133 |
| 532-34839-5 | 183 | 995-993-610-VS | 97 | 11964 | 117 | 81770-6 | 133 |
| 532-34839-6 | 183 | 995-993-620 | 97 | 11964 | 119 | 82292 | 117 |
| 532-37731-1 | 183 | 995-993-620-VS | 97 | 11965 | 117 | 82295 | 117 |
| 547-33924-1 | 111 | 995-993-630 | 97 | 11965 | 119 | 82570 | 30 |
| 547-33925-1 | 111 | 995-993-630-VS | 97 | 12658 | 117 | 82653 | 54 |
| 547-33926-1 | 111 | 995-993-660 | 97 | 12658 | 119 | 82655 | 54 |
| 554-32810-1 | 135 | 995-994-003 | 89 | 14253 | 113 | 82676 | 29 |
| 554-32811-1 | 135 | 995-994-006 | 89 | 14312 | 113 | 82885 | 22 |
| 554-32812-1 | 135 | 995-994-010 | 89 | 14361 | 113 | 82886 | 53 |
| 554-32813-1 | 135 | 995-994-016 | 89 | 69630 | 170 | 83167 | 55 |
| 554-32814-1 | 135 | 995-994-103 | 89 | 80072 | 77 | 83309-1 | 125 |
| 554-34387-1 | 135 | 995-994-103-VS | 89 | 80073 | 77 | 83309-2 | 125 |
| 624-29054-1 | 69 | 995-994-106 | 89 | 80074 | 77 | 83309-3 | 125 |
| 624-29054-1 | 77 | 995-994-106-VS | 89 | 80075 | 77 | 83309-4 | 125 |
| 624-29056-1 | 69 | 995-994-110 | 89 | 80077 | 77 | 83309-5 | 125 |
| 624-29056-1 | 77 | 995-994-110-VS | 89 | 80078 | 77 | 83309-6 | 125 |
| 624-77150-1 | 77 | 995-994-116 | 89 | 80079 | 77 | 83313 | 113 |
| 645-41176-1 | 77 | 995-994-116-VS | 89 | 80080 | 77 | 83314 | 125 |
| 645-41176-2 | 77 | 997-000-185 | 157 | 80081 | 77 | 83314-9 | 125 |
| 645-41176-3 | 77 | 1810 | 49 | 80082 | 77 | 83336-1 | 131 |
| 645-41177-1 | 77 | 1812 | 16 | 80083 | 77 | 83336-2 | 131 |
| 645-41177-3 | 77 | 1826 | 31 | 80084 | 77 | 83336-3 | 131 |
| 645-41325-3 | 35 | 2340-00000083 | 59 | 80085 | 77 | 83336-4 | 131 |

Index

| | | | | | | | |
|------------|-----|----------|-----|----------|-----|----------|-----|
| 83336HV-1 | 132 | 85307 | 156 | 85753 | 83 | 276919 | 83 |
| 83336HV-2 | 132 | 85307-DS | 156 | 85754 | 83 | 279630 | 156 |
| 83336HV-3 | 132 | 85460 | 66 | 85762MSO | 83 | 282288 | 67 |
| 83336HV-4 | 132 | 85474 | 83 | 85763MSO | 83 | 283167 | 21 |
| 83336HV-5 | 132 | 85475 | 83 | 85770-1 | 141 | 350241 | 186 |
| 83336HV-6 | 132 | 85479 | 83 | 85770-2 | 141 | 350242 | 186 |
| 83336HV-7 | 132 | 85492 | 63 | 85770-3 | 141 | 350244 | 186 |
| 83336HV-8 | 132 | 85492 | 83 | 85770-4 | 141 | 350245 | 186 |
| 83336HV-9 | 132 | 85497 | 140 | 85770-5 | 141 | 350282 | 187 |
| 83336HV-10 | 132 | 85664 | 83 | 85770-6 | 141 | 350283 | 187 |
| 83337 | 131 | 85665 | 83 | 85771 | 141 | 11390060 | 57 |
| 83337-9 | 131 | 85722 | 63 | 85772 | 141 | 11390070 | 57 |
| 83337HV | 132 | 85722MSO | 63 | 85878MSO | 83 | 11395200 | 75 |
| 83338 | 131 | 85723 | 63 | 086500 | 160 | 11395210 | 75 |
| 83338HV | 132 | 85724 | 63 | 086500 | 161 | 11395211 | 75 |
| 83535 | 113 | 85725 | 63 | 086501 | 160 | 11395227 | 75 |
| 83599 | 56 | 85725MSO | 63 | 086502 | 160 | 11395254 | 75 |
| 83660 | 115 | 85726 | 63 | 086503 | 160 | 11500608 | 152 |
| 83662 | 115 | 85727 | 63 | 086505 | 161 | 11500610 | 75 |
| 83667 | 22 | 85727MSO | 63 | 086506 | 161 | 11500610 | 151 |
| 83668 | 53 | 85728 | 83 | 086507 | 161 | 12375000 | 79 |
| 83715-1 | 125 | 85728MSO | 83 | 86535 | 154 | 12375020 | 79 |
| 83715-2 | 125 | 85729 | 83 | 91863-1 | 113 | 12375040 | 79 |
| 83715-3 | 125 | 85729MSO | 83 | 91864-1 | 113 | 12375060 | 79 |
| 83715-4 | 125 | 85730 | 83 | 91865-1 | 113 | 12375080 | 79 |
| 83715-6 | 125 | 85730MSO | 83 | 91866-1 | 113 | 12375100 | 79 |
| 83715-7 | 125 | 85731 | 63 | 91883-1 | 115 | 12375120 | 79 |
| 83724-1 | 131 | 85732 | 63 | 91884-1 | 115 | 12375140 | 79 |
| 83724-2 | 131 | 85733 | 63 | 91885-1 | 115 | 12375160 | 79 |
| 83724-3 | 131 | 85734 | 63 | 91886-1 | 115 | 12375180 | 79 |
| 83724-4 | 131 | 85735 | 63 | 91976-1 | 113 | 12375200 | 79 |
| 83748 | 119 | 85736 | 83 | 249279 | 113 | 12375220 | 79 |
| 83800 | 54 | 85737 | 83 | 249279 | 115 | 12375460 | 190 |
| 83817 | 48 | 85738 | 83 | 249280 | 113 | 12375461 | 190 |
| 83834 | 54 | 85739 | 83 | 249280 | 115 | 12375465 | 190 |
| 83900 | 125 | 85740 | 83 | 249281 | 113 | 12375466 | 190 |
| 83900-9 | 125 | 85741 | 63 | 249281 | 115 | 12375740 | 185 |
| 84048 | 113 | 85742 | 63 | 249282 | 113 | 12375740 | 189 |
| 84050 | 66 | 85743 | 83 | 249282 | 115 | 12375745 | 185 |
| 84110 | 115 | 85744 | 83 | 249649 | 113 | 12375745 | 189 |
| 84501 | 153 | 85745 | 83 | 270982 | 63 | 12375750 | 185 |
| 84616 | 63 | 85746 | 83 | 270982 | 83 | 12375750 | 189 |
| 84944 | 60 | 85747 | 83 | 271605 | 63 | 12375755 | 185 |
| 84960 | 61 | 85748 | 83 | 271606 | 63 | 12375755 | 189 |
| 84961 | 60 | 85749 | 83 | 272180 | 83 | 12375760 | 185 |
| 84962 | 61 | 85750 | 83 | 274899 | 83 | 12375760 | 189 |
| 84980 | 63 | 85751 | 83 | 276325 | 83 | 12375765 | 185 |
| 84990 | 63 | 85752 | 83 | 276903 | 83 | 12375765 | 189 |

Index

| | | | | | | | |
|---------------|-----|---------------------------|-----|-------------------------|----|------------------------|-----|
| 12375770..... | 185 | 12394440..... | 121 | KFU6-20+912..... | 37 | MFE5-KW6+299..... | 43 |
| 12375770..... | 189 | 12394550..... | 121 | KFU6-20+924..... | 37 | MFE5-KW6-S1+299..... | 43 |
| 12375775..... | 185 | 12394580..... | 121 | KFUS2-64+924..... | 37 | MFE5-KW6-S33+MGP..... | 43 |
| 12375775..... | 189 | 12394590..... | 121 | LF001/MR380..... | 33 | MFE5-KW6-S42+1GD..... | 43 |
| 12380200..... | 150 | 12395360..... | 121 | LF002/MR120..... | 33 | MFE5-KW6-S102+1FW..... | 43 |
| 12380210..... | 150 | 12395365..... | 121 | LF002/MR380..... | 33 | P-289..... | 23 |
| 12380218..... | 150 | 12501270..... | 149 | MCP15-1WA01X2-F10..... | 15 | P-846-2..... | 17 |
| 12380747..... | 75 | 12802500..... | 121 | MCP15-1WA01X2-F17..... | 15 | P-886..... | 28 |
| 12380760..... | 149 | 12802520..... | 121 | MCP15-1WA01XX-U10..... | 15 | PF-289..... | 23 |
| 12380765..... | 149 | 12802522..... | 121 | MCP15-1WA01XX-U17..... | 15 | PFW-289..... | 23 |
| 12381280..... | 79 | 12802540..... | 121 | MCP15-10A01X2-F05..... | 15 | PW-289..... | 23 |
| 12381285..... | 79 | 12802560..... | 121 | MCP15-10A01X2-F10..... | 15 | V71-010..... | 99 |
| 12381290..... | 79 | 12802580..... | 121 | MCP15-10A01X2-F17..... | 15 | V71-020..... | 99 |
| 12381292..... | 79 | ACP15-1WA11X2-F10..... | 25 | MCP15-10A01XX-U05..... | 15 | V71-040..... | 99 |
| 12381294..... | 79 | ACP15-1WA11X2-F17..... | 25 | MCP15-10A01XX-U10..... | 15 | V71-060..... | 99 |
| 12381296..... | 79 | ACP15-1WA11XX-U10..... | 25 | MCP15-10A01XX-U17..... | 15 | V71-100..... | 99 |
| 12381381..... | 65 | ACP15-1WA11XX-U17..... | 25 | MFE2-K3-2+299..... | 43 | V71-150..... | 99 |
| 12381382..... | 65 | ACP15-10A11X2-F05..... | 25 | MFE2-K3F-2+299..... | 43 | V72-005..... | 99 |
| 12381383..... | 65 | ACP15-10A11X2-F10..... | 25 | MFE2-K6F+299..... | 43 | VKU005-K..... | 109 |
| 12381384..... | 65 | ACP15-10A11X2-F17..... | 25 | MFE2-K6F-S2+299..... | 43 | VKU010-K..... | 109 |
| 12381385..... | 65 | ACP15-10A11XX-U05..... | 25 | MFE2-KW3F-S9+MGP..... | 43 | VKU020-K..... | 109 |
| 12381386..... | 65 | ACP15-10A11XX-U10..... | 25 | MFE2-KW3F-S13+1GD..... | 43 | VKU030-K..... | 109 |
| 12381700..... | 65 | ACP15-10A11XX-U17..... | 25 | MFE2-KW6F-S1+299..... | 43 | VKU040-K..... | 109 |
| 12381701..... | 65 | BPH30-3001AB-VAOM..... | 58 | MFE2-KW6F-S20+MGP..... | 43 | VKU060-K..... | 109 |
| 12381702..... | 65 | BPH30-3001AB-VAOM 1)..... | 59 | MFE2-KW6F-S37+1GD..... | 43 | VKU100-K..... | 109 |
| 12382666..... | 65 | BPH30-3101AB-VAOM..... | 58 | MFE5-B3-2+299..... | 43 | 501-302-302..... | 19 |
| 12389912..... | 75 | BPH30-3101AB-VAOM 1)..... | 59 | MFE5-BW3-2+299..... | 43 | 501-302-303..... | 19 |
| 12389916..... | 75 | DSC1-B040E-2A2B..... | 171 | MFE5-BW3-2-S28+299..... | 43 | 501-304-302..... | 19 |
| 12389919..... | 75 | DSC2-A100E-2A2B..... | 172 | MFE5-BW3-2-S34+1GD..... | 43 | 501-304-303..... | 19 |
| 12389924..... | 75 | DSC3-A100K-3A2B..... | 173 | MFE5-BW3-S41+MGP..... | 43 | 501-306-302..... | 19 |
| 12389925..... | 75 | EXZT2A02-E+471..... | 147 | MFE5-BW7+299..... | 43 | 501-306-303..... | 19 |
| 12389936..... | 75 | EXZT2A02-E+472..... | 147 | MFE5-BW7-S22+1GD..... | 43 | 501-301-302..... | 19 |
| 12389937..... | 75 | GS300..... | 182 | MFE5-BW7-S107+MGP..... | 43 | 501-301-303..... | 19 |
| 12389942..... | 75 | GS304P..... | 182 | MFE5-BW7-S222+MGP..... | 43 | 501-301-312..... | 19 |
| 12389943..... | 75 | IG 502-2-E+912..... | 157 | MFE5-BW16+299..... | 43 | 501-301-313..... | 19 |
| 12389944..... | 75 | IG 502-2-E+924..... | 157 | MFE5-BW16-S96+MGP..... | 43 | 81-270-000..... | 19 |
| 12389954..... | 75 | IGZ36-20-I+471..... | 147 | MFE5-BW16-S145+1GD..... | 43 | 995-900-105+PL3..... | 19 |
| 12390350..... | 121 | IGZ36-20-I+472..... | 147 | MFE5-BW16-S222+MGP..... | 43 | | |
| 12390400..... | 121 | IGZ36-20-S6-I+471..... | 147 | MFE5-BW30+299..... | 43 | | |
| 12390450..... | 121 | IGZ36-20-S6-I+472..... | 147 | MFE5-BW30-S30+29E..... | 43 | | |
| 12390500..... | 121 | IGZ38-30-I+471..... | 147 | MFE5-BW30-S35+MGP..... | 43 | | |
| 12390550..... | 121 | IGZ38-30-I+472..... | 147 | MFE5-BW30-S222+MGP..... | 43 | | |
| 12390600..... | 121 | IGZ38-30-S1-I+471..... | 147 | MFE5-K3-2+299..... | 43 | | |
| 12390610..... | 121 | IGZ38-30-S1-I+472..... | 147 | MFE5-K6+299..... | 43 | | |
| 12390615..... | 121 | IGZ51-20-S3-I+471..... | 147 | MFE5-KW3-2+299..... | 43 | | |
| 12390620..... | 121 | IGZ51-20-S3-I+472..... | 147 | MFE5-KW3-2-S4+299..... | 43 | | |
| 12394355..... | 121 | KFU2-40+912..... | 37 | MFE5-KW3-S24+MGP..... | 43 | | |
| 12394400..... | 121 | KFU2-40+924..... | 37 | MFE5-KW3-S37+1GD..... | 43 | | |



Important information on product usage

SKF and Lincoln lubrication systems or their components are not approved for use with gases, liquefied gases, pressurized gases in solution and fluids with a vapor pressure exceeding normal atmospheric pressure (1 013 mbar) by more than 0,5 bar at their maximum permissible temperature.



skf.com | skf.com/lubrication

© SKF and LINCOLN are registered trademarks of the SKF Group.

© SKF Group 2023

The contents of this publication are the copyright of the publisher and may not be reproduced (even extracts) unless prior written permission is granted. Every care has been taken to ensure the accuracy of the information contained in this publication but no liability can be accepted for any loss or damage whether direct, indirect or consequential arising out of the use of the information contained herein.

PUB LS/P1 17046 EN · July 2023

Certain image(s) used under license from Shutterstock.com